

IPv6 Ready Logo Phase 2
IP Multimedia Subsystem

Test Profile01
User Equipment

Version 0.4.0

IPv6 Forum
Converged Test Specification
IPv6 Logo Committee
IPv6 Promotion Council (Japan)

<http://www.ipv6forum.org>
<http://www.ipv6ready.org>



Modification Record

Version 0.3.0	Jun. 15, 2009	- Pre-release (trial version)
Version 0.3.1	Jun. 19, 2009	- Fixed a typo.
Version 0.3.2	Jul. 16, 2009	- Fixed a typo.
Version 0.4.0	Nov. 26, 2010	- Major version up (trial version) - Updated for 3GPP relase8



Acknowledgements

IPv6 Forum would like to acknowledge the efforts of the following organizations and commentators in the development of this test specification.

- IPv6 Promotion Council
Certification Working Group
SIP IPv6 Sub Working Group
BII Group

Commentators:

Note:

Development of this document was supported in part by a grant from NICT (National Institute of Information and Communications Technology).



Table of Contents

[I] IPv6 Ready Logo Phase 2 Test Specification IMS IPv6 User Equipment

Modification Record	i
Acknowledgements	ii
Table of Contents	iii
1 Overview	1
2 Requirements of conformance test	4
2.1 Requirements based on Policy of IMS IPv6 Ready Logo	4
2.2 Other Requirements	4
3 Common Observable Results	4
3.1 generic_sip_message	4
3.2 generic_REGISTER	5
3.3 generic_Auth_REGISTER	9
3.4 generic_re_REGISTER	13
3.5 generic_de_REGISTER	18
3.6 generic_SUBSCRIBE	22
3.7 generic_re_SUBSCRIBE	26
3.8 generic_200-NOTIFY	30
3.9 generic_INVITE	31
3.10 generic_180-INVITE	36
3.11 generic_200-INVITE	37
3.12 generic_ACK	41
3.13 generic_BYE	43
3.14 generic_200-BYE	46
3.15 generic_CANCEL	47
3.16 generic_200-CANCEL	49
3.17 generic_3XX-6XX	50
3.18 generic_ACK-non2XX	51
3.19 generic_OPTIONS	53
3.20 generic_200-OPTIONS	56
4 Test Profile: User Equipment operation (IMS-AKA)	60
4.1 Registration	60
4.1.1 UE-RG-B-1-AKA - Initial registration and subscription for the registration state event package (SIP default port values)	60
4.1.2 UE-RG-B-2-AKA - User-initiated reregistration	67
4.1.3 UE-RG-B-3-AKA - Network-initiated re-authentication	72
4.1.4 UE-RG-B-4-AKA - User-initiated deregistration	79
4.1.5 UE-RG-B-5-AKA - Network-initiated deregistration with rejected event	86
4.1.6 UE-RG-B-6-AKA - Network-initiated deregistration with deactivated event	92
4.1.7 UE-RG-B-7-AKA - Reception of 423 response to initial registration	101
4.1.8 UE-RG-B-8-AKA - Re-subscription for the registration state event package	107



4.1.9	UE-RG-B-9-AKA	- Reception of 481 response to subscription for the registration state event package.....	113
4.1.10	UE-RG-B-10-AKA	- Reception of a new service-route to reregistration.....	119
4.1.11	UE-RG-B-11-AKA	- Reception of 423 response to reregistration.....	128
4.1.12	UE-RG-B-12-AKA	- Reception of 408 response to reregistration	134
4.1.13	UE-RG-B-13-AKA	- Reception of 500 response to reregistration	142
4.1.14	UE-RG-B-14-AKA	- Reception of 504 response to reregistration	151
4.1.15	UE-RG-B-15-AKA	- Timer F expiration (Registration)	159
4.1.16	UE-RG-B-16-AKA	- Reception of 401 response with no Security-Server header to initial registration	167
4.1.17	UE-RG-B-17-AKA	- Charge from the old SAs to the new SAs.....	173
4.1.18	UE-RG-B-18-AKA	- Invalid authentication parameter (MAC) and 403 response.....	183
4.1.19	UE-RG-B-19-AKA	- Invalid authentication parameter(SQN)	195
4.1.20	UE-RG-B-20-AKA	- User-initiated deregistration and dialog release	204
4.1.21	UE-RG-B-21-AKA	- Reception of 401 response to user-initiated deregistration.....	213
4.1.22	UE-RG-B-22-AKA	- Reception of 503 response to subscription for the registration state event package.....	218
4.1.23	UE-RG-B-23-AKA	- Security association (DES-EDE3-CBC and HMAC-MD5-96).....	222
4.1.24	UE-RG-B-24-AKA	- Security association (AES-CBC and HMAC-SHA-1-96).....	229
4.2	Session Establishment		237
4.2.1	UE-SE-B-1-AKA	- Session initiation and termination (Sends INVITE and receives BYE).....	237
4.2.2	UE-SE-B-2-AKA	- Session initiation and termination (Sends INVITE and sends BYE)	244
4.2.3	UE-SE-B-3-AKA	- Session initiation and termination (Receives INVITE and receives BYE).....	251
4.2.4	UE-SE-B-4-AKA	- Session initiation and termination (Receives INVITE and sends BYE).....	259
4.2.5	UE-SE-B-5-AKA	- Call cancellation (Sends INVITE and sends CANCEL)	266
4.2.6	UE-SE-B-6-AKA	- Call cancellation (Receives INVITE and receives CANCEL).....	272
4.2.7	UE-SE-B-7-AKA	- SIP response received from the P-CSCF outside of the registration.....	279
4.2.8	UE-SE-B-8-AKA	- SIP Request received from the P-CSCF outside of the registration.....	286
4.2.9	UE-SE-B-9-AKA	- Receiving 503 response to INVITE.....	288
4.2.10	UE-SE-B-10-AKA	- Receiving forked 180 and 200 response	297
4.3	SDP		308
4.3.1	UE-SD-B-1-AKA	- SDP offer which included one or more media lines which was offered with several codecs (Receives INVITE and sends BYE)	308
4.3.2	UE-SD-B-2-AKA	- SDP offer which included an IP address type that is not supported (Receives INVITE and sends BYE).....	315
4.4	OPTIONS		320
4.4.1	UE-OP-B-1-AKA	- OPTIONS request (Sends OPTIONS).....	320
4.4.2	UE-OP-B-2-AKA	- OPTIONS request (Receives OPTIONS).....	324



4.5	SIP timer	328
4.5.1	UE-TM-B-1-AKA - Timer B expiration to INVITE.....	328
4.5.2	UE-TM-B-2-AKA - Timer D expiration.....	332
4.5.3	UE-TM-B-3-AKA - Timer H expiration.....	337
4.5.4	UE-TM-B-4-AKA - Timer J expiratoin	342
4.5.5	UE-TM-B-5-AKA - Timer F expiration (In Session).....	348
4.6	Sending Response	353
4.6.1	UE-SR-B-1-AKA - Sending 400 response	353
4.6.2	UE-SR-B-2-AKA - Sending 404 response	357
4.6.3	UE-SR-B-3-AKA - Sending 405 response	362
4.6.4	UE-SR-B-4-AKA - Sending 406 response	366
4.6.5	UE-SR-B-5-AKA - Sending 414 response	371
4.6.6	UE-SR-B-6-AKA - Sending 415 response	376
4.6.7	UE-SR-B-7-AKA - Sending 416 response	381
4.6.8	UE-SR-B-8-AKA - Sending 420 response	386
4.6.9	UE-SR-B-9-AKA - Sending 480/486 response	391
4.6.10	UE-SR-B-10-AKA - Sending 482 response	396
4.6.11	UE-SR-B-11-AKA - Sinding 489 response	406
4.6.12	UE-SR-B-12-AKA - Sending 500 response	410
4.6.13	UE-SR-B-13-AKA - Sending 505 response	419
4.7	Receiving Response	424
4.7.1	UE-RR-B-1-AKA - Receiving 100 response	424
4.7.2	UE-RR-B-2-AKA - Receiving 181 response (Call transfer by S-CSCFa2 to UEa2').....	435
4.7.3	UE-RR-B-3-AKA - Receiving 182 response (Request is queued by P-CSCFa2).....	443
4.7.4	UE-RR-B-4-AKA - Receiving 183 responsee	448
4.7.5	UE-RR-B-5-AKA - Receiving 202 response	453
4.7.6	UE-RR-B-6-AKA - Receiving 400 response	456
4.7.7	UE-RR-B-7-AKA - Receiving 404 response	459
4.7.8	UE-RR-B-8-AKA - Receiving 405 response	463
4.7.9	UE-RR-B-9-AKA - Receiving 406 response	467
4.7.10	UE-RR-B-10-AKA - Receiving 410 response	472
4.7.11	UE-RR-B-11-AKA - Receiving 413 response	476
4.7.12	UE-RR-B-12-AKA - Receiving 414 response	481
4.7.13	UE-RR-B-13-AKA - Receiving 415 response	484
4.7.14	UE-RR-B-14-AKA - Response 480 response	488
4.7.15	UE-RR-B-15-AKA - Receiving 482 response	491
4.7.16	UE-RR-B-16-AKA - Receiving 483 response	494
4.7.17	UE-RR-B-17-AKA - Receiving 484 response	498
4.7.18	UE-RR-B-18-AKA - Receiving 485 response	501
4.7.19	UE-RR-B-19-AKA - Receiving 488 response	505
4.7.20	UE-RR-B-20-AKA - Receiving 501 response	509
4.7.21	UE-RR-B-21-AKA - Receivning 502 response	513
4.7.22	UE-RR-B-22-AKA - Receiving 505 response	516



4.7.23	UE-RR-B-23-AKA - Receiving 513 response	520
4.7.24	UE-RR-B-24-AKA - Receiving 600 response	524
4.7.25	UE-RR-B-25-AKA - Receiving 603 response	528
4.7.26	UE-RR-B-26-AKA - Receiving 604 response	532
4.7.27	UE-RR-B-27-AKA - Receiving 606 response	535
4.7.28	UE-RR-B-28-AKA - Reception of 504 response to Session initiation	539
4.8	SigComp	544
4.8.1	UE-SC-B-1-AKA - SigComp for IMS (Sends INVITE and receives BYE)	544
4.8.2	UE-SC-B-2-AKA - SigComp for IMS (Receive INVITE and send BYE)	564
Appendix	Mapping table	578



1 Overview

This document describes details of the IMS Conformance Test. The format of the description block is as follows:

Description block

[NAME]	NAME is a name of the test.
[TARGET]	TARGET is a target node of the test.
[PURPOSE]	PURPOSE is a short statement describing what the test attempts to achieve. It is usually phrased as a simple assertion of the feature or capability to be tested.
[REFERENCE]	REFERENCE section contains some parts of specification related to the tests. It also shows the document names and section numbers.
[REQUIREMENT]	REQUIREMENT section specifies the functions and conditions that will be needed to perform the test.
[PARAMETER]	PARAMETER describes SIP URIs on the topology that relates to the test
[ADDRESS]	ADDRESS describes IP addresses on the topology that relates to the test.
[TOPOLOGY]	TOPOLOGY describes the network used in the test.
[INITIALIZATION]	INITIALIZATION describes step-by-step instructions for carrying out the setting before the test.
[PROCEDURE]	PROCEDURE describes step-by-step instructions for carrying out the test.
[OBSERVABLE RESULTS]	OBSERVABLE RESULTS describes expected result. If we can observe as same result as the description of Judgment, the NUT passes the test.

NOTE: There are common observable results in the category of OBSERVABLE RESULTS. Refer to Section 3.

Acronyms

UE	- IMS User Equipment
P-CSCF	- IMS Proxy- Call/Session Control Function
I-CSCF	- IMS Interrogating- Call/Session Control Function
S-CSCF	- IMS Serving- Call/Session Control Function
IF	- Interface
UNI	- User-Network Interface
NNI	- Network-Network Interface



Reference standards

The following documents are referenced in the test specifications.

[IMS]

- (1) TS 24.229: IP multimedia call control protocol based on Session Initiation Protocol (SIP) and Session Description Protocol (SDP); Stage 3(Release 8), 3GPP TS 24.229 v8.10.0.
(<http://www.3gpp.org/ftp/Specs/html-info/24229.htm>)

[SIP/SDP]

- (2) RFC3261: SIP: Session Initiation Protocol (<http://www.ietf.org/rfc/rfc3261.txt>)
- (3) RFC3265: Session Initiation Protocol (SIP)-Specific Event Notification
(<http://www.ietf.org/rfc/rfc3265.txt>)
- (4) RFC3327: Session Initiation Protocol (SIP) Extension Header Field for Registering Non-Adjacent Contacts (<http://www.ietf.org/rfc/rfc3327.txt>)
- (5) RFC3455: Private Header (P-Header) Extensions to the Session Initiation Protocol (SIP) for the 3rd-Generation Partnership Project (3GPP)
(<http://www.ietf.org/rfc/rfc3455.txt>)
- (6) RFC3608: Session Initiation Protocol (SIP) Extension Header Field for Service Route Discovery During Registration (<http://www.ietf.org/rfc/rfc3608.txt>)
- (7) RFC3680: A Session Initiation Protocol (SIP) Event Package for Registrations
(<http://www.ietf.org/rfc/rfc3680.txt>)
- (8) RFC4320: Actions addressing identified issues with the Session Initiation Protocol's non-INVITE Transaction (<http://www.ietf.org/rfc/rfc4320.txt>)
- (9) RFC4566: SDP: Session Description Protocol (<http://www.ietf.org/rfc/rfc4566.txt>)

[SigComp]

- (10) RFC3320: Signaling Compression (SigComp) (<http://www.ietf.org/rfc/rfc3320.txt>)
- (11) RFC3485: The Session Initiation Protocol (SIP) and Session Description Protocol (SDP) Static Dictionary for Signaling Compression (SigComp) (<http://www.ietf.org/rfc/rfc3485.txt>)
- (12) RFC3486: Compressing the Session Initiation Protocol (<http://www.ietf.org/rfc/rfc3486.txt>)
- (13) RFC4896: Signaling Compression (SigComp) Corrections and Clarifications
(<http://www.ietf.org/rfc/rfc4896.txt>)
- (14) RFC5049: Applying Signaling Compression (SigComp) to the Session Initiation Protocol (SIP)
(<http://www.ietf.org/rfc/rfc5049.txt>)

[IMS AKA and Security Association]

- (15) TS.33.203: 3G security; Access security for IP-based services (Release8), 3GPP TS 33.203 v8.8.0.
(<http://www.3gpp.org/ftp/Specs/html-info/33203.htm>)
- (16) RFC3310: Hypertext Transfer Protocol (HTTP) Digest Authentication Using Authentication and Key Agreement (AKA) (<http://www.ietf.org/rfc/rfc3310.txt>)
- (17) RFC3329: Security Mechanism Agreement for the Session Initiation Protocol (SIP)
(<http://www.ietf.org/rfc/rfc3329.txt>)

[SIP Digest]

- (18) RFC2617: HTTP Authentication: Basic and Digest Access Authentication



(<http://www.ietf.org/rfc/rfc2617.txt>)

[Call Flow Examples]

(19) TS24.228: Signalling flows for the IP multimedia call control based on Session Initiation Protocol (SIP) and Session Description Protocol (SDP); Stage 3, 3GPP TS 24.228 v5.15.0.

(<http://www.3gpp.org/ftp/Specs/html-info/24228.htm>)

(20) RFC3665: SIP Basic Call Flow Examples (<http://www.ietf.org/rfc/rfc3665.txt>)



2 Requirements of conformance test

2.1 Requirements based on Policy of IMS IPv6 Ready Logo

[PRq]

1. Supported transport protocol is only UDP.
2. The path MTU is 1500 bytes.
3. Supported URI scheme is only SIP-URI.
4. Only unicast session is supported.

2.2 Other Requirements

[ORq]

1. INVITE requests includes the bodies and any other requests doesn't include the bodies.
2. IMS-AKA is mandatory for all UEs containing a UICC at registration.

3 Common Observable Results

3.1 generic_sip_message

Generic judgement items for SIP message.

-The start-line, each message-header line, and the empty line **MUST** be terminated by a carriage-return line-feed sequence (CRLF).[RFC3261-7-1]

- Request-Line:

-Applications sending SIP messages **MUST** include a SIP-Version of "SIP/2.0".
[RFC3261-7.1-3]

-Implementations **MUST** send upper-case. [RFC3261-7.1-4]

- Header fields:

* Content-Length

-Applications **SHOULD** use this field to indicate the size of the message-body to be transferred.[RFC3261-20.14-1]

* From

-Even if the "display-name" is empty, the "name-addr" form **MUST** be



used if the "addr-spec" contains a comma, question mark, or semicolon.
[RFC3261-20.20-2]

3.2 generic_REGISTER

Generic judgement items for REGISTER request.

See generic_sip_message

-The empty line MUST be present even if the message-body is not. [RFC3261-7-2]

[Digest]

-The locally available public user identity, the private user identity, and the domain name to be used in the Request-URI SHALL be used in the registration by UE.
[TS24229-5.1-100]

- Request-Line:

-Request-URI SHALL be set to the SIP URI of the domain name of the home network.[TS24229-5.1-41]

-The Request-URI MUST NOT contain unescaped space control characters.
[RFC3261-7.1-1]

-The Request-URI MUST NOT be enclosed in "<>". [RFC3261-7.1-2]

-The "userinfo" and "@" components of the SIP URI MUST NOT be present.
[RFC3261-10.2-4]

- Header fields:

-An Expires header field or the expires parameter within the Contact header field SHALL be set to the value of 600 000 seconds.
[TS24229-5.1-40]

-SIP request MUST contain To, From, CSeq, Call-ID, Max-Forwards, and Via header fields. [RFC3261-8.1-1]

[AKA]

-The client MUST add both a Require and Proxy-Require header field with the value "sec-agree" to its request.[RFC3329-2.3-4]

[Digest]

-Security-Client, Security-Verify header field and both a Require and Proxy-Require header fields with the value "sec-agree" SHALL not be included in any SIP messages if SIP digest without TLS is used.
[TS24229-5.1-9]



* Authorization header

-WWW-Authenticate, Authorization, Proxy-Authenticate or Proxy-Authorization MUST NOT be combined into a single header field row. [RFC3261-7.3-3]

[AKA]

- The username directive in Authorization header field SHALL be set to the value of the private user identity.[TS24229-5.1-69]
- The realm directive in Authorization header field SHALL be set to the value of the domain name of the home network.[TS24229-5.1-70]
- The uri directive in Authorization header field SHALL be set to the SIP URI of the domain name of the home network.[TS24229-5.1-71]
- The nonce directive in Authorization header field SHALL be empty. [TS24229-5.1-72]
- The response directive in Authorization header field SHALL be empty. [TS24229-5.1-73]

[Digest]

- The username directive in Authorization header field SHALL be set to the value of the private user identity. [TS24229-5.1-93]
- The realm directive in Authorization header field SHALL be set to the value of the domain name of the home network. [TS24229-5.1-94]
- The uri directive in Authorization header field SHALL be set to the SIP URI of the domain name of the home network. [TS24229-5.1-95]
- The nonce directive in Authorization header field SHALL be empty. [TS24229-5.1-96]
- The response directive in Authorization header field SHALL be empty. [TS24229-5.1-97]

* Contact

- Contact header field SHALL be set to SIP URIs containing the IP address or FQDN of the UE in the hostport parameter or FQDN. [TS24229-5.1-33]
- UACs SHOULD NOT use the "action" parameter.[RFC3261-10.2-9]
- Even if the "display-name" is empty, the "name-addr" form MUST be used if the "addr-spec" contains a comma, semicolon, or question mark.[RFC3261-20.10-1]

[AKA]

- The hostport parameter in Contact header field SHALL include the protected server port value if the REGISTER request is protected by a security association.[TS24229-5.1-74]

[Digest]

- The hostport parameter in Contact header field SHALL be set to an



unprotected port where the UE expects to receive subsequent requests.
[TS24229-5.1-98]

* Content-length

-If no body is present in a message, then the Content-Length header field value MUST be set to zero.[RFC3261-20.14-3]

* CSeq

-The Cseq method MUST match the method of Request-Line in the request.[RFC3261-8.1-14]

-The sequence number value in the CSeq header field MUST be expressible as a 32-bit unsigned integer. [RFC3261-8.1-15][RFC3261-20.16-1]

-The sequence number value in the CSeq header field MUST be less than $2^{*}31$. [RFC3261-8.1-16]

* From

-From header field SHALL be set to the SIP URI that contains the public user identity to be registered or deregistered.[TS24229-5.1-31]

-The From field MUST contain a new "tag" parameter, chosen by the UAC.[RFC3261-8.1-9]

* Max-Forwards

-A UAC MUST insert a Max-Forwards header field into each request it originates. [RFC3261-8.1-17]

-The Max-Forwards header field value SHOULD be 70. [RFC3261-8.1-18]

* To

-To header field SHALL be set to the SIP URI that contains the public user identity to be registered or deregistered.[TS24229-5.1-32]

-A request outside of a dialog MUST NOT contain a To tag. [RFC3261-8.1-7]

-An address-of-record included in To header field MUST be a SIP URI or SIPS URI.[RFC3261-10.2-5]

* P-Access-Network-Info

-3GPP UA SHOULD NOT send P-Access-Network-Info header in any initial unauthenticated and unprotected request.[RFC3455-6.4-2]

* P-Called-Party-ID

-A UAC MUST NOT insert a P-Called-Party-ID header field in any SIP request or response.[RFC3455-4.2-1]



* Security-Client [AKA]

- The Security-Client header field SHALL be set to the security mechanism the UE supports, the IPsec layer algorithms the UE supports and the parameters needed for the security association setup.[TS24229-5.1-76]
- A client wishing to use the security agreement of this specification MUST add a Security-Client header field to a request addressed to its first-hop proxy.[RFC3329-2.3-2]

* Supported

- The option tag "path " SHALL be contained in the Supported header field.[TS24229-5.1-42]
- The UA SHOULD include the option tag "path" as a header field value in all Supported header fields.[RFC3327-5.1-1]
- The UA SHOULD include a Supported header field in all requests. [RFC3327-5.1-2]

* Via

- The sent-by field of the Via header field shall include the IP address or FQDN of the UE and the port number where the UE expects to receive the response to this request when UDP is used.[TS24229-5.1-37]
- A UAC MUST insert a Via into that request. [RFC3261-8.1-19]
- The protocol name and protocol version in the Via header field MUST be SIP and 2.0. [RFC3261-8.1-20]
- The Via header field value MUST contain a branch parameter. [RFC3261-8.1-21]
- The branch ID MUST always begin with the characters "z9hG4bK". [RFC3261-8.1-23]
- The client transport MUST insert a value of the "sent-by" field into the Via header field.[RFC3261-18.1-7]

[AKA]

- The protected server port value SHALL be included in the sent-by field of the Via header field for the UDP.[TS24229-5.1-75]

[Digest]

- The sent-by field in Via header field SHALL be set to an unprotected port where the UE expects to receive subsequent requests. [TS24229-5.1-99]

- Security Associations behavior [AKA]

- A Security-setup-line SHALL be included in REGISTER request in order to start the security mode set-up procedure.[TS33203-7.2-1]



3.3 generic_Auth_REGISTER

Generic judgement items for Auth_REGISTER request.

See generic_sip_message

- The empty line **MUST** be present even if the message-body is not. [RFC3261-7-2]
- The client **SHOULD NOT** retry the same request without modification. [RFC3261-21.4-1]

- Request-Line:

- The Request-URI **MUST NOT** contain unescaped space control characters. [RFC3261-7.1-1]
- The Request-URI **MUST NOT** be enclosed in "<>". [RFC3261-7.1-2]
- The "userinfo" and "@" components of the SIP URI **MUST NOT** be present. [RFC3261-10.2-4]

- Header fields:

- SIP request **MUST** contain To, From, CSeq, Call-ID, Max-Forwards, and Via header fields.[RFC3261-8.1-1]
- This new request **SHOULD** have the same value of the Call-ID, To, and From of the previous request, but the CSeq should contain a new sequence number that is one higher than the previous. [RFC3261-8.1-62]

[AKA]

- The client **MUST** add both a Require and Proxy-Require header field with the value "sec-agree" to its request.[RFC3329-2.3-4]
- A subsequent SIP requests **MUST** also have both a Require and Proxy-Require header fields with the value "sec-agree".[RFC3329-2.3-16]

[Digest]

- The REGISTER request **SHALL** not include Security-Client, Security-Verify header field and both a Require and Proxy-Require header fields with the value "sec-agree" if SIP digest without TLS is used.[TS24229-5.1-259]

* Authorization

- WWW-Authenticate, Authorization, Proxy-Authenticate or Proxy-Authorization **MUST NOT** be combined into a single header field row. [RFC3261-7.3-3]

[AKA]

- The UE **SHALL** include an Authorization header as defined for the initial REGISTER



request that was challenged with the received 401 (Unauthorized) response.
[TS24229-5.1-226]

- The "realm" header field parameter in Authorization header field SHALL be set to the value as received in the "realm" header field in the WWW Authenticate header field.[TS24229-5.1-227]
 - The "username" header field parameter in Authorization header field SHALL be set to the value of the private user identity.[TS24229-5.1-228]
 - The "response" header field parameter in Authorization header field SHALL be set to the RES parameter.[TS24229-5.1-229]
 - The "uri" header field parameter in Authorization header field SHALL be set to the SIP URI of the domain name of the home network.[TS24229-5.1-230]
 - The "algorithm" header field parameter in Authorization header field SHALL be set to the value received in the 401 (Unauthorized) response.
[TS24229-5.1-231]
 - The "nonce" header field parameter in Authorization header field SHALL be set to the value received in the 401(Unauthorized) response.[TS24229-5.1-232]
- [Digest]

- Another REGISTER request SHALL be sent containing an Authorization header field.[TS24229-5.1-256]
- Authorization header fields are populated as defined for the initial registration, with the addition that the header field SHALL be populated a challenge response, i.e. "cnonce", "qop", and "nonce-count" header field parameters.[TS24229-5.1-257]
- The 'uri' parameter of the Authorization header field MUST be enclosed in quotation marks.[RFC3261-22.4-20]
- If a client receives a "qop" parameter in a challenge header field, it MUST send the "qop" parameter in any resulting authorization header field.[RFC3261-22.4-23]
- The qop value MUST be one of the alternatives the server indicated it supports in the WWW-Authenticate header, if present.[RFC2617-3-4]
- The qop SHOULD be used if the server indicated that qop is supported by providing a qop directive in the WWW-Authenticate header field.
[RFC2617-3-5]
- The cnonce MUST be specified if a qop directive is sent a qop directive in the WWW-Authenticate header field.[RFC2617-3-6]
- The cnonce MUST NOT be specified if the server did not send a qop directive in the WWW-Authenticate header field.[RFC2617-3-7]
- The nonce-count MUST be specified if a qop directive is sent a qop directive in the WWW-Authenticate header field.[RFC2617-3-8]
- The nonce-count MUST NOT be specified if the server did not send a qop directive in the WWW-Authenticate header field.[RFC2617-3-9]



* Call-ID

- The Call-ID header field SHOULD be the same in each registration from a UA.[RFC3261-8.1-11]
- All registrations from a UAC SHOULD use the same Call-ID header field value for registrations sent to a particular registrar. [RFC3261-10.2-6]

[AKA]

- Call-ID of the security association protected REGISTER request which carries the authentication challenge response SHALL be set to the same value as the Call-ID of the 401 (Unauthorized) response. [TS24229-5.1-235]

[Digest]

- Call-ID of REGISTER request which carries the authentication challenge response SHALL be set to the same value as the Call-ID of the 401 (Unauthorized) response which carried the challenge.[TS24229-5.1-258]

* Contact

- UACs SHOULD NOT use the "action" parameter.[RFC3261-10.2-9]
- Even if the "display-name" is empty, the "name-addr" form MUST be used if the "addr-spec" contains a comma, semicolon, or question mark.[RFC3261-20.10-1]

* Content-length

- If no body is present in a message, then the Content-Length header field value MUST be set to zero.[RFC3261-20.14-3]

* CSeq

- The Cseq method MUST match the method of Request-Line in the request.[RFC3261-8.1-14]
- The sequence number value in the CSeq header field MUST be expressible as a 32-bit unsigned integer. [RFC3261-8.1-15][RFC3261-20.16-1]
- The sequence number value in the CSeq header field MUST be less than 2^{31} . [RFC3261-8.1-16]
- A UA MUST increment the CSeq value by one for each REGISTER request with the same Call-ID.[RFC3261-10.2-7]

* From

- The From field MUST contain a new "tag" parameter, chosen by the UAC.[RFC3261-8.1-9]

* Max-Forwards

- A UAC MUST insert a Max-Forwards header field into each request it



originates. [RFC3261-8.1-17]

-The Max-Forwards header field value SHOULD be 70.
[RFC3261-8.1-18]

* P-Called-Party-ID

-A UAC MUST NOT insert a P-Called-Party-ID header field in any SIP request or response.[RFC3455-4.2-1]

* Security-Client [AKA]

-Security-Client header field that is identical to the Security-Client header field that was included in the previous REGISTER request SHALL be inserted into the request.
[TS24229-5.1-233]

-A client wishing to use the security agreement of this specification MUST add a Security-Client header field to a request addressed to its first-hop proxy.[RFC3329-2.3-2]

* Security-Verify [AKA]

-The Security-Verify header field SHALL be mirrored the content of the Security-Server header field received in the 401 (Unauthorized) response.[TS24229-5.1-234]

-A subsequent SIP requests MUST contain a Security-Verify header field that mirrors the server's list received previously in the Security- Server header field.[RFC3329-2.3-15]

* Supported

-The UA SHOULD include the option tag "path" as a header field value in all Supported header fields.[RFC3327-5.1-1]

-The UA SHOULD include a Supported header field in all requests.
[RFC3327-5.1-2]

* To

-A request outside of a dialog MUST NOT contain a To tag.
[RFC3261-8.1-7]

-An address-of-record included in To header field MUST be a SIP URI or SIPS URI.[RFC3261-10.2-5]

* Via

-A UAC MUST insert a Via into that request. [RFC3261-8.1-19]

-The protocol name and protocol version in the Via header field MUST be SIP and 2.0. [RFC3261-8.1-20]

-The Via header field value MUST contain a branch parameter.



[RFC3261-8.1-21]

-The branch ID MUST always begin with the characters "z9hG4bK".

[RFC3261-8.1-23]

-The client transport MUST insert a value of the "sent-by" field into the Via header field.[RFC3261-18.1-7]

- Security Association behavior [AKA]

-A temporary set of security associations SHALL be set up based on the static list and parameters it received in the 401 (Unauthorized) response and its capabilities sent in the Security-Client header field in the REGISTER request.[TS24229-5.1-221]

-The temporary set of security associations SHALL be set up using the most preferred mechanism and algorithm returned by the P-CSCF and supported by the UE and using IK and CK as the shared key. [TS24229-5.1-222]

-The parameters received in the Security-Server header field SHALL be used to setup the temporary set of security associations. [TS24229-5.1-223]

-REGISTER request SHALL be sent using the temporary set of security associations to protect the message.[TS24229-5.1-225]

-The REGISTER request for authentication SHALL include the integrity and encryption algorithms list, SPI_P, and Port_P received in 401 (Unauthorized) response, and SPI_U, Port_U sent in the initial REGISTER request.[TS33203-7.2-9]

-The REGISTER request for authentication to the P-CSCF SHALL be protected with the new outbound SA.[TS33203-7.4-18]

-All the subsequent SIP requests sent by the client to that server SHOULD make use of the security mechanism initiated in the previous step.[RFC3329-2.3-14]

-All clients MUST select HTTP Digest, TLS, IPsec, or any stronger method for the protection of the second request.[RFC3329-5-1]

3.4 generic_re_REGISTER

Generic judgement items for re_REGISTER request

See generic_sip_message

-The empty line MUST be present even if the message-body is not. [RFC3261-7-2]

-Registration refreshes SHOULD be sent to the same network address as the original registration.[RFC3261-10.2-16]



- Request-Line:

- Request-URI SHALL be set to the SIP URI of the domain name of the home network.[TS24229-5.1-162]
- The Request-URI MUST NOT contain unescaped space control characters. [RFC3261-7.1-1]
- The Request-URI MUST NOT be enclosed in "<>". [RFC3261-7.1-2]
- The "userinfo" and "@" components of the SIP URI MUST NOT be present. [RFC3261-10.2-4]

- Header fields

- An Expires header field or the expires parameter within the Contact header field SHALL be set to the value of 600 000 seconds.[TS24229-5.1-161]
- SIP request MUST contain To, From, CSeq, Call-ID, Max-Forwards, and Via header fields. [RFC3261-8.1-1]

[AKA]

- The client MUST add both a Require and Proxy-Require header field with the value "sec-agree" to its request.[RFC3329-2.3-4]
- A subsequent SIP requests MUST also have both a Require and Proxy-Require header fields with the value "sec-agree".[RFC3329-2.3-16]

[Digest]

- The REGISTER request SHALL not include Security-Client, Security-Verify header field and both a Require and Proxy-Require header fields with the value "sec-agree" if SIP digest without TLS is used.[TS24229-5.1-259]

* Authorization header

- WWW-Authenticate, Authorization, Proxy-Authenticate or Proxy-Authorization MUST NOT be combined into a single header field row. [RFC3261-7.3-3]

[AKA]

- The username directive in Authorization header field SHALL be set to the value of the private user identity.[TS24229-5.1-183]
- The realm directive in Authorization header field SHALL be set to the value as received in the realm directive in the WWW Authenticate header field.[TS24229-5.1-184]
- The uri directive in Authorization header field SHALL be set to the SIP URI of the domain name of the home network. [TS24229-5.1-185]
- The nonce directive in Authorization header field SHALL be set to last received nonce value.[TS24229-5.1-186]



-The response directive in Authorization header field SHALL be set to the last calculated response value.[TS24229-5.1-187]

[Digest]

-The username directive in Authorization header field SHALL be set to the value of the private user identity.[TS24229-5.1-193]

-The realm directive in Authorization header field SHALL be set to the value of the domain name of the home network.[TS24229-5.1-194]

-The uri directive in Authorization header field SHALL be set to the SIP URI of the domain name of the home network.[TS24229-5.1-195]

-The nonce directive in Authorization header field SHALL be empty. [TS24229-5.1-196]

-The response directive in Authorization header field SHALL be empty. [TS24229-5.1-197]

* From

-From header field SHALL be set to the SIP URI that contains the public user identity to be registered or deregistered.[TS24229-5.1-155]

-The From field MUST contain a new "tag" parameter, chosen by the UAC.[RFC3261-8.1-9]

* Max-Forwards

-A UAC MUST insert a Max-Forwards header field into each request it originates. [RFC3261-8.1-17]

-The Max-Forwards header field value SHOULD be 70. [RFC3261-8.1-18]

* Call-ID

-The Call-ID header field SHOULD be the same in each registration from a UA.[RFC3261-8.1-11]

-All registrations from a UAC SHOULD use the same Call-ID header field value for registrations sent to a particular registrar. [RFC3261-10.2-6]

-A UA SHOULD use the same Call-ID for all registrations during a single boot cycle.[RFC3261-10.2-15]

* Contact

-Contact header field SHALL be set to IP address or FQDN. [TS24229-5.1-157]

-UACs SHOULD NOT use the "action" parameter.[RFC3261-10.2-9]

-Even if the "display-name" is empty, the "name-addr" form MUST be used if the "addr-spec" contains a comma, semicolon, or question mark.[RFC3261-20.10-1]

[AKA]



-Contact header field SHALL be set to protected server port value.
[TS24229-5.1-188]

[Digest]

-The port value in Contact header field SHALL be set to an unprotected port where the UE expects to receive subsequent requests.
[TS24229-5.1-198]

* Content-length

-If no body is present in a message, then the Content-Length header field value MUST be set to zero.[RFC3261-20.14-3]

* CSeq

-The Cseq method MUST match the method of Request-Line in the request.
[RFC3261-8.1-14]

-The sequence number value in the CSeq header field MUST be expressible as a 32-bit unsigned integer. [RFC3261-8.1-15][RFC3261-20.16-1]

-The sequence number value in the CSeq header field MUST be less than $2^{*}31$. [RFC3261-8.1-16]

-A UA MUST increment the CSeq value by one for each REGISTER request with the same Call-ID.[RFC3261-10.2-7]

* To

-To header field SHALL be set to the SIP URI that contains the public user identity to be registered or deregistered.[TS24229-5.1-156]

-A request outside of a dialog MUST NOT contain a To tag. [RFC3261-8.1-7]

-An address-of-record included in To header field MUST be a SIP URI or SIPS URI.[RFC3261-10.2-5]

* P-Called-Party-ID

-A UAC MUST NOT insert a P-Called-Party-ID header field in any SIP request or response.[RFC3455-4.2-1]

* Security-Client [AKA]

-Security-Client header field SHALL be set to the security mechanism it supports, the IPsec layer algorithms for security and confidentiality protection it supports and the new parameter values needed for the setup of two new pairs of security associations.[TS24229-5.1-190]

-A client wishing to use the security agreement of this specification MUST add a Security-Client header field to a request addressed to its first-hop proxy.[RFC3329-2.3-2]



* Security-Verify [AKA]

- Security-Verify header field SHALL be set to the content of the Security-Server header received in the 401 (Unauthorized) response of the last successful authentication.[TS24229-5.1-191]
- A subsequent SIP requests MUST contain a Security-Verify header field that mirrors the server's list received previously in the Security- Server header field.[RFC3329-2.3-15]

* Supported

- The option tag "path" SHALL be contained in Supported header field. [TS24229-5.1-163]
- The UA SHOULD include the option tag "path" as a header field value in all Supported header fields.[RFC3327-5.1-1]
- The UA SHOULD include a Supported header field in all requests. [RFC3327-5.1-2]

* Via

- Via header field SHALL be set to IP address or FQDN. [TS24229-5.1-160]
- A UAC MUST insert a Via into that request. [RFC3261-8.1-19]
- The protocol name and protocol version in the Via header field MUST be SIP and 2.0. [RFC3261-8.1-20]
- The Via header field value MUST contain a branch parameter. [RFC3261-8.1-21]
- The branch ID MUST always begin with the characters "z9hG4bK". [RFC3261-8.1-23]
- The client transport MUST insert a value of the "sent-by" field into the Via header field.[RFC3261-18.1-7]

[AKA]

- The protected server port value for the UDP SHALL be included in Via header field.[TS24229-5.1-189]

[Digest]

- The port value in Via header field SHALL be set to an unprotected port where the UE expects to receive responses to the request. [TS24229-5.1-199]

- Security Association behavior [AKA]

- The REGISTER request SHALL be protected using a security association established as a result of an earlier registration.[TS24229-5.1-153]
- A Security-setup-line SHALL be included in REGISTER request in order to start the security mode set-up procedure.[TS33203-7.2-1]
- The first message in this registration SHOULD be protected with an SA



- created by a previous successful authentication if one exists.
[TS33203-7.3-8]
- An already active pair of security associations SHALL be used to protect the REGISTER request.[TS33203-7.4-3]
- A particular security association SHALL protect the certain messages in the authentication.[TS33203-7.4-12]
- The REGISTER request SHALL be protected with the old outbound security association if the initial REGISTER request was protected.
[TS33203-7.4-14]
- All the subsequent SIP requests sent by the client to that server SHOULD make use of the security mechanism initiated in the previous step.[RFC3329-2.3-14]

3.5 generic_de_REGISTER

Generic judgement items for de_REGISTER request.

See generic_sip_message

- The empty line MUST be present even if the message-body is not. [RFC3261-7-2]

 - Request-Line:
 - Request-URI SHALL be set to the SIP URI of the domain name of the home network.[TS24229-5.1-302]
 - The Request-URI MUST NOT contain unescaped space control characters. [RFC3261-7.1-1]
 - The Request-URI MUST NOT be enclosed in "<>". [RFC3261-7.1-2]
 - The "userinfo" and "@" components of the SIP URI MUST NOT be present. [RFC3261-10.2-4]

 - Header fields:
 - Expires header or the expires parameter of the Contact header field SHALL be set to the value of zero.[TS24229-5.1-301]
 - SIP request MUST contain To, From, CSeq, Call-ID, Max-Forwards, and Via header fields. [RFC3261-8.1-1]
 - The REGISTER-specific Contact header field value of "*" applies to all registrations, but it MUST NOT be used unless the Expires header field is present with a value of "0".[RFC3261-10.2-13]
- [AKA]



-The client **MUST** add both a Require and Proxy-Require header field with the value "sec-agree" to its request.[RFC3329-2.3-4]

-A subsequent SIP requests **MUST** also have both a Require and Proxy-Require header fields with the value "sec-agree".[RFC3329-2.3-16]

[Digest]

-The REGISTER request **SHALL** not include Security-Client, Security-Verify header field and both a Require and Proxy-Require header fields with the value "sec-agree" if SIP digest without TLS is used.[TS24229-5.1-259]

* Authorization

-WWW-Authenticate, Authorization, Proxy-Authenticate or Proxy-Authorization **MUST NOT** be combined into a single header field row. [RFC3261-7.3-3]

[AKA]

-The username directive in Authorization header field **SHALL** be set to the value of the private user identity.[TS24229-5.1-313]

-The realm directive in Authorization header field **SHALL** be set to the value as received in the realm directive in the WWW-Authenticate header.[TS24229-5.1-314]

-The uri directive in Authorization header field **SHALL** be set to the SIP URI of the domain name of the home network.
[TS24229-5.1-315]

-The nonce directive in Authorization header field **SHALL** be set to last received nonce value.[TS24229-5.1-316]

-The response directive in Authorization header field **SHALL** be set to the last calculated response value.[TS24229-5.1-317]

[Digest]

-The username directive in Authorization header field **SHALL** be set to the value of the private user identity.[TS24229-5.1-323]

-The realm directive in Authorization header field **SHALL** be set to the value of the domain name of the home network.[TS24229-5.1-324]

-The uri directive in Authorization header field **SHALL** be set to the SIP URI of the domain name of the home network.[TS24229-5.1-325]

-The nonce directive in Authorization header field **SHALL** be empty.
[TS24229-5.1-326]

-The response directive in Authorization header field **SHALL** be empty.
[TS24229-5.1-327]

* Call-ID

-The Call-ID header field **SHOULD** be the same in each registration from a UA.[RFC3261-8.1-11]

-All registrations from a UAC **SHOULD** use the same Call-ID header



field value for registrations sent to a particular registrar.
[RFC3261-10.2-6]

* Contact

-SIP URI(s) that contain(s) in the hostport parameter the IP address of the UE or FQDN SHALL be included in Contact header field.

[TS24229-5.1-298]

-UACs SHOULD NOT use the "action" parameter.[RFC3261-10.2-9]

-Even if the "display-name" is empty, the "name-addr" form MUST be used if the "addr-spec" contains a comma, semicolon, or question mark.[RFC3261-20.10-1]

[AKA]

-Contact header field SHALL be set to the protected server port value bound to the security association.[TS24229-5.1-318]

[Digest]

-The port value in Contact header field SHALL be set to the associated unprotected port value (where the UE was expecting to receive mid-dialog requests).[TS24229-5.1-328]

* Content-length

-If no body is present in a message, then the Content-Length header field value MUST be set to zero.[RFC3261-20.14-3]

* CSeq

-The Cseq method MUST match the method of Request-Line in the request.
[RFC3261-8.1-14]

-The sequence number value in the CSeq header field MUST be expressible as a 32-bit unsigned integer. [RFC3261-8.1-15][RFC3261-20.16-1]

-The sequence number value in the CSeq header field MUST be less than 2^{31} . [RFC3261-8.1-16]

-A UA MUST increment the CSeq value by one for each REGISTER request with the same Call-ID.[RFC3261-10.2-7]

* From

-From header field SHALL be set to the SIP URI that contains the public user identity to be registered or deregistered.[TS24229-5.1-296]

-The From field MUST contain a new "tag" parameter, chosen by the UAC.[RFC3261-8.1-9]

* Max-Forwards

-A UAC MUST insert a Max-Forwards header field into each request it originates. [RFC3261-8.1-17]



-The Max-Forwards header field value SHOULD be 70. [RFC3261-8.1-18]

* P-Called-Party-ID

-A UAC MUST NOT insert a P-Called-Party-ID header field in any SIP request or response.[RFC3455-4.2-1]

* Security-Client [AKA]

-Security-Client header field SHALL be set to the security mechanism it supports, the IPsec layer algorithms for integrity and confidentiality protection it supports and the new parameter values needed for the setup of two new pairs of security associations.[TS24229-5.1-320]

-A client wishing to use the security agreement of this specification MUST add a Security-Client header field to a request addressed to its first-hop proxy.[RFC3329-2.3-2]

* Security-Verify [AKA]

-Security-Verify header field SHALL be set to the content of the Security-Server header received in the 401 (Unauthorized) response of the last successful authentication.[TS24229-5.1-322]

-A subsequent SIP requests MUST contain a Security-Verify header field that mirrors the server's list received previously in the Security-Server header field.[RFC3329-2.3-15]

* Supported

-The UA SHOULD include the option tag "path" as a header field value in all Supported header fields.[RFC3327-5.1-1]

-The UA SHOULD include a Supported header field in all requests. [RFC3327-5.1-2]

* To

-To header field SHALL be set to the SIP URI that contains the public user identity to be registered or deregistered.[TS24229-5.1-297]

-A request outside of a dialog MUST NOT contain a To tag. [RFC3261-8.1-7]

-An address-of-record included in To header field MUST be a SIP URI or SIPS URI.[RFC3261-10.2-5]

* Via

-The IP address or FQDN of the UE SHALL be included in Via header field.[TS24229-5.1-300]

-A UAC MUST insert a Via into that request. [RFC3261-8.1-19]



- The protocol name and protocol version in the Via header field MUST be SIP and 2.0. [RFC3261-8.1-20]
- The Via header field value MUST contain a branch parameter. [RFC3261-8.1-21]
- The branch ID MUST always begin with the characters "z9hG4bK". [RFC3261-8.1-23]
- The client transport MUST insert a value of the "sent-by" field into the Via header field. [RFC3261-18.1-7]

[AKA]

- The protected server port value for the UDP SHALL be included in Via header field. [TS24229-5.1-319]

[Digest]

- The port value in Via header field SHALL be set to an unprotected port where the UE expects to receive responses to the request. [TS24229-5.1-329]

- Security Association behavior [AKA]

- The REGISTER request SHALL be protected using a security association established as a result of an earlier registration. [TS24229-5.1-290]
- A Security-setup-line SHALL be included in REGISTER request in order to start the security mode set-up procedure. [TS33203-7.2-1]
- All the subsequent SIP requests sent by the client to that server SHOULD make use of the security mechanism initiated in the previous step. [RFC3329-2.3-14]

3.6 generic_SUBSCRIBE

Generic judgement items for SUBSCRIBE request.

See generic_sip_message

- The empty line MUST be present even if the message-body is not. [RFC3261-7-2]

- Request-Line:

- Request-URI SHALL be set to the resource to which the UE wants to be subscribed to. [TS24229-5.1-123]
- The Request-URI MUST NOT contain unescaped space control characters. [RFC3261-7.1-1]
- The Request-URI MUST NOT be enclosed in "<>". [RFC3261-7.1-2]
- The initial Request-URI of the message SHOULD be set to the value of



the URI in the To field.[RFC3261-8.1-2]

- Header fields:

-SIP request MUST contain To, From, CSeq, Call-ID, Max-Forwards, and Via header fields. [RFC3261-8.1-1]

[AKA]

-These requests MUST also have both a Require and Proxy-Require header fields with the value "sec-agree".[RFC3329-2.3-16]

[Digest]

-Security-Client, Security-Verify header field and both a Require and Proxy-Require header fields with the value "sec-agree" SHALL not be included in any SIP messages if SIP digest without TLS is used.[TS24229-5.1-363]

* Allow-Events

-Any node implementing one or more event packages SHOULD include an appropriate "Allow-Events" header indicating all supported events in all methods which initiate dialogs and their responses and OPTIONS responses.[RFC3265-3.3-5]

* Contact

-Contact header field SHALL be set to IP address or FQDN as in the initial registration .[TS24229-5.1-129]

-The Contact header field MUST be present and contain exactly one SIP or SIPS URI in any request that can result in the establishment of a dialog.[RFC3261-8.1-24]

-Even if the "display-name" is empty, the "name-addr" form MUST be used if the "addr-spec" contains a comma, semicolon, or question mark.[RFC3261-20.10-1]

[AKA]

-Contact header field set to contain the protected server port value as in the initial registration.[TS24229-5.1-130]

-UE SHALL populate the Contact header field of the request with the protected server port and the respective contact address if the UE has not obtained a GRUU and IMS AKA is being used. [TS24229-5.1-355]

[Digest]

-The port value in Contact header field SHALL be set to an unprotected port where the UE expects to receive subsequent mid-dialog requests. [TS24229-5.1-131]

-The port value in Contact header field SHALL be set the unprotected port value to the port value used in the initial REGISTER request.



[TS24229-5.1-132]

-UE SHALL populate the Contact header field of the request with the port value of an unprotected port and the contact address where the UE expects to receive subsequent mid-dialog requests if the UE has not obtained a GRUU and SIP digest without TLS is being used.[TS24229-5.1-357]

* Content-length

-If no body is present in a message, then the Content-Length header field value MUST be set to zero.[RFC3261-20.14-3]

* CSeq

-The Cseq method MUST match the method of Request-Line in the request.[RFC3261-8.1-14][RFC3261-12.2-11]

-The sequence number value in the CSeq header field MUST be expressible as a 32-bit unsigned integer.[RFC3261-8.1-15][RFC3261-20.16-1]

-The sequence number value in the CSeq header field MUST be less than 2^{31} . [RFC3261-8.1-16]

* Event

-Event header field SHALL be set to the "reg" event package.
[TS24229-5.1-126]

-Subscribers MUST include exactly one "Event" header in SUBSCRIBE requests, indicating to which event or class of events they are subscribing.[RFC3265-3.1-4]

-There MUST be exactly one event type listed per event header.
[RFC3265-7.2-2]

* Expires

-Expires header field SHALL be set to 600 000 seconds as the value desired for the duration of the subscription.[TS24229-5.1-127]

-The SUBSCRIBE requests SHOULD contain an "Expires" header.
[RFC3265-3.1-1]

* From

-From header field SHALL be set to a SIP URI that contains the public user identity used for subscription.[TS24229-5.1-124]

-The From field MUST contain a new "tag" parameter, chosen by the UAC.
[RFC3261-8.1-9]

* Max-Forwards

-A UAC MUST insert a Max-Forwards header field into each request it



originates.[RFC3261-8.1-17]

-The Max-Forwards header field value SHOULD be 70.[RFC3261-8.1-18]

* P-Called-Party-ID

-A UAC MUST NOT insert a P-Called-Party-ID header field in any SIP request or response.[RFC3455-4.2-1]

* P-Preferred-Identity

-The P-Preferred-Identity header field SHALL be used as the public user identity for the request if a P-Preferred-Identity was included. [TS24229-5.1-378]

[AKA]

-The default public user identity for the security association SHALL be used as the public user identity for the request if no P-Preferred-Identity was included.[TS24229-5.1-379]

* Route

-A proper preloaded Route header value SHALL be built in Route header for all new dialog and standalone transactions.[TS24229-5.1-398]

-A list of Route header values made out of the P-CSCF URI containing the IP address or the FQDN learnt through the P-CSCF discovery procedure SHALL be built in Route header. [TS24229-5.1-400]

-A list of Route header values made out of the values received in the Service-Route header field saved from the 200 (OK) response to the last registration or re-registration of the public user identity with associated contact address SHALL be built in Route header. [TS24229-5.1-404]

-If the request contains a Route header field, the request SHOULD be sent to the locations derived from its topmost value. [RFC3261-8.1-38]

[AKA]

-A list of Route header values made out of the P-CSCF port containing the protected server port learned during the registration procedure SHALL be built in Route header. [TS24229-5.1-402]

[Digest]

-A list of Route header values made out of the P-CSCF port containing the unprotected server port learned during the registration procedure SHALL be built in Route header. [TS24229-5.1-403]

* Security-Verify [AKA]

-A subsequent SIP requests MUST contain a Security-Verify header field that mirrors the server's list received previously in the



Security- Server header field.[RFC3329-2.3-15]

* To

- To header field SHALL be set to a SIP URI that contains the public user identity used for subscription.[TS24229-5.1-125]
- A request outside of a dialog MUST NOT contain a To tag. [RFC3261-8.1-7]

* Via

- A UAC MUST insert a Via into that request. [RFC3261-8.1-19]
- The protocol name and protocol version in the Via header field MUST be SIP and 2.0. [RFC3261-8.1-20]
- The Via header field value MUST contain a branch parameter. [RFC3261-8.1-21]
- The branch ID MUST always begin with the characters "z9hG4bK". [RFC3261-8.1-23]
- The client transport MUST insert a value of the "sent-by" field into the Via header field.[RFC3261-18.1-7]

[AKA]

- The protected server port and the respective contact address SHALL be included in the Via header entry relating to the UE if the has not obtained a GRUU and IMS AKA is being used.[TS24229-5.1-356]

[Digest]

- UE SHALL populate the Via header field of the request with the port value of an unprotected port and the respective contact address where the UE expects to receive responses to the request if the has not obtained a GRUU and SIP digest without TLS is being used.[TS24229-5.1-358]

- Security Association behavior [AKA]

- All the subsequent SIP requests sent by the client to that server SHOULD make use of the security mechanism initiated in the previous step.[RFC3329-2.3-14]

3.7 generic_re_SUBSCRIBE

Generic judgement items for Re-SUBSCRIBE request.

See generic_sip_message

- The information for the established dialog and the expiration time as indicated in the Expires header field of the received response SHALL be



stored by UE.[TS24229-5.1-133]

-The empty line MUST be present even if the message-body is not. [RFC3261-7-2]

- Request-Line:

-The Request-URI MUST NOT contain unescaped space control characters. [RFC3261-7.1-1]

-The Request-URI MUST NOT be enclosed in "<>". [RFC3261-7.1-2]

-The UAC MUST place the remote target URI into the Request-URI if the route set is not empty and the first URI in the route set contains the lr parameter.[RFC3261-12.2-14]

- Header fields:

-SIP request MUST contain To, From, CSeq, Call-ID, Max-Forwards, and Via header fields. [RFC3261-8.1-1]

[AKA]

-A subsequent SIP requests MUST also have both a Require and Proxy-Require header fields with the value "sec-agree".[RFC3329-2.3-16]

[Digest]

-Security-Client, Security-Verify header field and both a Require and Proxy-Require header fields with the value "sec-agree" SHALL not be included in any SIP messages if SIP digest without TLS is used.[TS24229-5.1-363]

* Allow-Events

-Any node implementing one or more event packages SHOULD include an appropriate "Allow-Events" header indicating all supported events in all methods which initiate dialogs and their responses and OPTIONS responses.[RFC3265-3.3-5]

* Call-ID

-The Call-ID header field MUST be the same for all requests and responses sent by either UA in a dialog.[RFC3261-8.1-10]

-The Call-ID of the request MUST be set to the Call-ID of the dialog. [RFC3261-12.2-6]

* Contact

-The UE SHOULD insert the previously used Contact header field in Contact header field. [TS24229-5.1-386]

-Even if the "display-name" is empty, the "name-addr" form MUST be used if the "addr-spec" contains a comma, semicolon, or question mark. [RFC3261-20.10-1]



[AKA]

- UE SHALL populate the Contact header field of the request with the protected server port and the respective contact address if the UE has not obtained a GRUU and IMS AKA is being used. [TS24229-5.1-355]

[Digest]

- UE SHALL populate the Contact header field of the request with the port value of an unprotected port and the contact address where the UE expects to receive subsequent mid-dialog requests if the UE has not obtained a GRUU and SIP digest without TLS is being used. [TS24229-5.1-357]

* Content-length

- If no body is present in a message, then the Content-Length header field value MUST be set to zero.[RFC3261-20.14-3]

* CSeq

- The Cseq method MUST match the method of Request-Line in the request. [RFC3261-8.1-14]
- The sequence number value in the CSeq header field MUST be expressible as a 32-bit unsigned integer.[RFC3261-8.1-15][RFC3261-20.16-1]
- The sequence number value in the CSeq header field MUST be less than 2^{31} . [RFC3261-8.1-16]
- Requests within a dialog MUST contain strictly monotonically increasing and contiguous CSeq sequence numbers in each direction.[RFC3261-12.2-7]
- The value of the local sequence number MUST be incremented by one if the local sequence number is not empty.[RFC3261-12.2-8]
- The value of the local sequence number that be incremented by one MUST be placed into the CSeq header field if the local sequence number is not empty.[RFC3261-12.2-9]

* Event

- Subscribers MUST include exactly one "Event" header in SUBSCRIBE requests, indicating to which event or class of events they are subscribing.[RFC3265-3.1-4]
- There MUST be exactly one event type listed per event header. [RFC3265-7.2-2]

* Expires

- The SUBSCRIBE requests SHOULD contain an "Expires" header. [RFC3265-3.1-1]



* From

- The From URI of the request **MUST** be set to the local URI from the dialog state.[RFC3261-12.2-3]
- The tag in the From header field of the request **MUST** be set to the local tag of the dialog ID.[RFC3261-12.2-4]

* Max-Forwards

- A UAC **MUST** insert a Max-Forwards header field into each request it originates. [RFC3261-8.1-17]
- The Max-Forwards header field value **SHOULD** be 70. [RFC3261-8.1-18]

* P-Called-Party-ID

- A UAC **MUST NOT** insert a P-Called-Party-ID header field in any SIP request or response.[RFC3455-4.2-1]

* Route

- If the request contains a Route header field, the request **SHOULD** be sent to the locations derived from its topmost value. [RFC3261-8.1-38]
- The UAC **MUST** include a Route header field containing the route set values in order including all parameters if the route set is not empty, and the first URI in the route set contains the lr parameter.[RFC3261-12.2-15]

* Security-Verify [AKA]

- A subsequent SIP requests **MUST** contain a Security-Verify header field that mirrors the server's list received previously in the Security-Server header field.[RFC3329-2.3-15]

* To

- The URI in the To field of the request **MUST** be set to the remote URI from the dialog state.[RFC3261-12.2-1]
- The tag in the To header field of the request **MUST** be set to the remote tag of the dialog ID.[RFC3261-12.2-2]

* Via

- A UAC **MUST** insert a Via into that request. [RFC3261-8.1-19]
- The protocol name and protocol version in the Via header field **MUST** be SIP and 2.0.[RFC3261-8.1-20]
- The Via header field value **MUST** contain a branch parameter. [RFC3261-8.1-21]
- The branch ID **MUST** always begin with the characters "z9hG4bK".



[RFC3261-8.1-23]

-The client transport **MUST** insert a value of the "sent-by" field into the Via header field.[RFC3261-18.1-7]

[AKA]

-The protected server port and the respective contact address **SHALL** be included in the Via header entry relating to the UE if the has not obtained a GRUU and IMS AKA is being used.[TS24229-5.1-356]

[Digest]

-UE **SHALL** populate the Via header field of the request with the port value of an unprotected port and the respective contact address where the UE expects to receive responses to the request if the has not obtained a GRUU and SIP digest without TLS is being used.[TS24229-5.1-358]

- Security Association behavior [AKA]

-All the subsequent SIP requests sent by the client to that server **SHOULD** make use of the security mechanism initiated in the previous step.[RFC3329-2.3-14]

3.8 generic_200-NOTIFY

Generic judgement items for 200-NOTIFY response.

See generic_sip_message

-The empty line **MUST** be present even if the message-body is not. [RFC3261-7-2]

-TUs **SHOULD** respond immediately to non-INVITE requests.[RFC3261-17.1-1]

- Header fields:

* Call-ID

-The Call-ID header field **MUST** be the same for all requests and responses sent by either UA in a dialog.[RFC3261-8.1-10]

-The Call-ID header field of the response **MUST** equal the Call-ID header field of the request.[RFC3261-8.2-37]

* Content-length

-If no body is present in a message, then the Content-Length header field value **MUST** be set to zero.[RFC3261-20.14-3]

* CSeq

-The CSeq header field of the response **MUST** equal the CSeq field of



the request.[RFC3261-8.2-38]

* From

-The From field of the response MUST equal the From header field of the request.[RFC3261-8.2-36]

* P-Called-Party-ID

-A UAC MUST NOT insert a P-Called-Party-ID header field in any SIP request or response.[RFC3455-4.2-1]

* To

-If a request contained a To tag in the request, the To header field in the response MUST equal that of the request.[RFC3261-8.2-41]
-The same tag MUST be used for all responses to that request, both final and provisional. [RFC3261-8.2-44]

* Via

-The Via header field values in the response MUST equal the Via header field values in the request and MUST maintain the same ordering. [RFC3261-8.2-39][RFC3261-8.2-40]
-If the host portion of the "sent-by" parameter contains a domain name, or if it contains an IP address that differs from the packet source address, the server MUST add a "received" parameter to that Via header field value.[RFC3261-18.2-5]
-The "received" parameter MUST contain the source address from which the packet was received.[RFC3261-18.2-6]
-The response MUST be sent to the address in the "received" parameter, using the port indicated in the "sent-by" value, or using port 5060 if none is specified explicitly.[RFC3261-18.2-13]

3.9 generic_INVITE

Generic judgement items for INVITE request.

See generic_sip_message

- Request-Line:

-The Request-URI MUST NOT contain unescaped space control characters. [RFC3261-7.1-1]
-The Request-URI MUST NOT be enclosed in "<>". [RFC3261-7.1-2]



-The initial Request-URI of the message SHOULD be set to the value of the URI in the To field.[RFC3261-8.1-2]

- Header fields:

-The UE SHALL include the Accept header field with "application/sdp", the MIME type associated with the 3GPP IM CN subsystem XML body and any other MIME type the UE is willing and capable to accept, when generating an initial INVITE request, [TS24229-5.1-454]

-SIP request MUST contain To, From, CSeq, Call-ID, Max-Forwards, and Via header fields. [RFC3261-8.1-1]

[AKA]

-These requests MUST also have both a Require and Proxy-Require header fields with the value "sec-agree".[RFC3329-2.3-16]

[Digest]

-Security-Client, Security-Verify header field and both a Require and Proxy-Require header fields with the value "sec-agree" SHALL not be included in any SIP messages if SIP digest without TLS is used.[TS24229-5.1-363]

* Allow

-A UA that supports INVITE MUST also support ACK, CANCEL and BYE. [RFC3261-13.1-1]

-An Allow header field SHOULD be present in the INVITE. [RFC3261-13.2-1]

* Allow-Events

-Any node implementing one or more event packages SHOULD include an appropriate "Allow-Events" header indicating all supported events in all methods which initiate dialogs and their responses and OPTIONS responses.[RFC3265-3.3-5]

* Contact

-The Contact header field MUST be present and contain exactly one SIP or SIPS URI in any request that can result in the establishment of a dialog.[RFC3261-8.1-24]

-Even if the "display-name" is empty, the "name-addr" form MUST be used if the "addr-spec" contains a comma, semicolon, or question mark.[RFC3261-20.10-1]

[AKA]

-UE SHALL populate the Contact header field of the request with the protected server port and the respective contact address if the UE has not obtained a GRUU and IMS AKA is being used.



[TS24229-5.1-355]

[Digest]

-UE SHALL populate the Contact header field of the request with the port value of an unprotected port and the contact address where the UE expects to receive subsequent mid-dialog requests if the UE has not obtained a GRUU and SIP digest without TLS is being used.[TS24229-5.1-357]

* Content-Encoding

-If the body has not undergone any encoding such as compression, then Content-Encoding MUST be omitted. [RFC3261-7.4-3]

* Content-Type

-The Internet media type of the message body MUST be given by the Content-Type header field.[RFC3261-7.4-1]

-The Content-Type header field MUST be present if the body is not empty.[RFC3261-20.15-1]

* CSeq

-The Cseq method MUST match the method of Request-Line in the request. [RFC3261-8.1-14]

-The sequence number value in the CSeq header field MUST be expressible as a 32-bit unsigned integer. [RFC3261-8.1-15][RFC3261-20.16-1]

-The sequence number value in the CSeq header field MUST be less than 2^{31} . [RFC3261-8.1-16]

* From

-The From field MUST contain a new "tag" parameter, chosen by the UAC. [RFC3261-8.1-9]

* Max-Forwards

-A UAC MUST insert a Max-Forwards header field into each request it originates.[RFC3261-8.1-17]

-The Max-Forwards header field value SHOULD be 70.[RFC3261-8.1-18]

* P-Called-Party-ID

-A UAC MUST NOT insert a P-Called-Party-ID header field in any SIP request or response.[RFC3455-4.2-1]

* Route

-A proper preloaded Route header value SHALL be built in Route header for all new dialog and standalone transactions.[TS24229-5.1-398]



-A list of Route header values made out of the P-CSCF URI containing the IP address or the FQDN learnt through the P-CSCF discovery procedure SHALL be built in Route header. [TS24229-5.1-400]

-A list of Route header values made out of the values received in the Service-Route header field saved from the 200 (OK) response to the last registration or re-registration of the public user identity with associated contact address SHALL be built in Route header. [TS24229-5.1-404]

-If the request contains a Route header field, the request SHOULD be sent to the locations derived from its topmost value. [RFC3261-8.1-38]

[AKA]

-A list of Route header values made out of the P-CSCF port containing the protected server port learned during the registration procedure SHALL be built in Route header. [TS24229-5.1-402]

[Digest]

-A list of Route header values made out of the P-CSCF port containing the unprotected server port learned during the registration procedure SHALL be built in Route header. [TS24229-5.1-403]

* P-Preferred-Identity

-The P-Preferred-Identity header field SHALL be used as the public user identity for the request if a P-Preferred-Identity was included. [TS24229-5.1-378]

[AKA]

-The default public user identity for the security association SHALL be used as the public user identity for the request if no P-Preferred-Identity was included. [TS24229-5.1-379]

* Security-Verify [AKA]

-A subsequent SIP requests MUST contain a Security-Verify header field that mirrors the server's list received previously in the Security-Server header field. [RFC3329-2.3-15]

* Supported

-A Supported header field SHOULD be present in the INVITE. [RFC3261-13.2-3]

* To

-A request outside of a dialog MUST NOT contain a To tag. [RFC3261-8.1-7]

* Via



- A UAC MUST insert a Via into that request. [RFC3261-8.1-19]
- The protocol name and protocol version in the Via header field MUST be SIP and 2.0. [RFC3261-8.1-20]
- The Via header field value MUST contain a branch parameter. [RFC3261-8.1-21]
- The branch ID MUST always begin with the characters "z9hG4bK". [RFC3261-8.1-23]
- The client transport MUST insert a value of the "sent-by" field into the Via header field.[RFC3261-18.1-7]

[AKA]

- The protected server port and the respective contact address SHALL be included in the Via header entry relating to the UE if the has not obtained a GRUU and IMS AKA is being used.[TS24229-5.1-356]

[Digest]

- UE SHALL populate the Via header field of the request with the port value of an unprotected port and the respective contact address where the UE expects to receive responses to the request if the has not obtained a GRUU and SIP digest without TLS is being used.[TS24229-5.1-358]

- Bodies fields:

- The SDP payloads SHALL not be encrypted.[TS24229-6.1-1]
- Only SDP payload SHALL be contained in SIP messages when the SDP payload must be included in the message.[TS24229-6.1-3]
- A SDP offer and at least one media description SHALL be contained in an INVITE request generated by a UE.[TS24229-6.1-26]
- The Session Description Protocol MUST be supported by all user agents as a means to describe sessions.[RFC3261-13.2-12]
- Whitespace MUST NOT be used on either side of the "=" sign. [RFC4566-5-2]
- v,o,s,(c),t,m,(c) lines are REQUIRED in the SDP message.
(c line MUST included session level information or all of media information)
[RFC4566-5-3]
- all MUST appear in exactly the following order:
"v,o,s,(i),(w),(e),(p),(c),(b),t,(r),(z),(k),(a),m,(i),(c),(b),(k),(a)"
(the line enclosed in "()" is OPTIONAL)[RFC4566-5-4]

* o line

- For both IP4 and IP6, the fully qualified domain name is the form that SHOULD be given unless this is unavailable, in which case the globally unique address MAY be substituted.[RFC4566-5.2-3]

* s line



- There MUST be one and only one "s=" field per session description. [RFC4566-5.3-1]
- The "s=" field MUST NOT be empty. [RFC4566-5.3-2]
- If a session has no meaningful name, the value "s= " SHOULD be used. [RFC4566-5.3-4]

* c line

- A session description MUST contain either at least one "c=" field in each media description or a single "c=" field at the session level. [RFC4566-5.7-1]
- A session-level "c=" field MUST NOT specify Multiple addresses or "c=" lines. [RFC4566-5.7-7]

* b line

- The proposed bandwidth for each media stream utilizing the "b=" media descriptor and the "AS" bandwidth modifier in the SDP SHALL be specified for "video" and "audio" media types that utilize the RTP/RTCP. [TS24229-6.1-7]

- Security Association behavior [AKA]

- All the subsequent SIP requests sent by the client to that server SHOULD make use of the security mechanism initiated in the previous step. [RFC3329-2.3-14]

3.10 generic_180-INVITE

Generic judgement items for 180-INVITE response.

See generic_sip_message

- The empty line MUST be present even if the message-body is not. [RFC3261-7-2]

- Header fields:

* Call-ID

- The Call-ID header field of the response MUST equal the Call-ID header field of the request. [RFC3261-8.2-37]

* Content-length

- If no body is present in a message, then the Content-Length header field value MUST be set to zero. [RFC3261-20.14-3]



- * CSeq
 - The CSeq header field of the response MUST equal the CSeq field of the request.[RFC3261-8.2-38]
- * From
 - The From field of the response MUST equal the From header field of the request.[RFC3261-8.2-36]
- * P-Called-Party-ID
 - A UAC MUST NOT insert a P-Called-Party-ID header field in any SIP request or response.[RFC3455-4.2-1]
- * To
 - If the To header field in the request did not contain a tag, the URI in the To header field in the response MUST equal the URI in the To header field. [RFC3261-8.2-42]
 - If the To header field in the request did not contain a tag, the UAS MUST add a tag to the To header field in the response. [RFC3261-8.2-43]
- * Via
 - The Via header field values in the response MUST equal the Via header field values in the request and MUST maintain the same ordering. [RFC3261-8.2-39][RFC3261-8.2-40]
 - If the host portion of the "sent-by" parameter contains a domain name, or if it contains an IP address that differs from the packet source address, the server MUST add a "received" parameter to that Via header field value.[RFC3261-18.2-5]
 - The "received" parameter MUST contain the source address from which the packet was received.[RFC3261-18.2-6]
 - The response MUST be sent to the address in the "received" parameter, using the port indicated in the "sent-by" value, or using port 5060 if none is specified explicitly.[RFC3261-18.2-13]

3.11 generic_200-INVITE

Generic judgement items for 200-INVITE response.

See generic_sip_message



- Header fields:

-A 2xx response to an INVITE SHOULD contain the Allow header field and the Supported header field.[RFC3261-13.3-10]

* Allow

-A UA that supports INVITE MUST also support ACK, CANCEL and BYE. [RFC3261-13.1-1]

* Allow-Events

-Any node implementing one or more event packages SHOULD include an appropriate "Allow-Events" header indicating all supported events in all methods which initiate dialogs and their responses and OPTIONS responses.[RFC3265-3.3-5]

* Call-ID

-The Call-ID header field MUST be the same for all requests and responses sent by either UA in a dialog.[RFC3261-8.1-10]
-The Call-ID header field of the response MUST equal the Call-ID header field of the request.[RFC3261-8.2-37]

* Contact

-The UAS MUST add a Contact header field to the response. [RFC3261-12.1-4]
-The URI provided in the Contact header field MUST be a SIP or SIPS URI.[RFC3261-12.1-5]
-Even if the "display-name" is empty, the "name-addr" form MUST be used if the "addr-spec" contains a comma, semicolon, or question mark.[RFC3261-20.10-1]

[AKA]

-The protected server port SHALL be included in the address in the Contact header field if UE did not insert a GRUU.[TS24229-5.1-444]

[Digest]

-The port value of an unprotected port where the UE expects to receive subsequent mid-dialog requests SHALL be included in the address in the Contact header field if UE did not insert a GRUU and SIP digest without TLS is being used.[TS24229-5.1-445]

* Content-Encoding

-If the body has not undergone any encoding such as compression, then Content-Encoding MUST be omitted. [RFC3261-7.4-3]



- * Content-Type
 - The Internet media type of the message body MUST be given by the Content-Type header field. [RFC3261-7.4-1]
 - The Content-Type header field MUST be present if the body is not empty. [RFC3261-20.15-1]
- * CSeq
 - The CSeq header field of the response MUST equal the CSeq field of the request. [RFC3261-8.2-38]
- * From
 - The From field of the response MUST equal the From header field of the request. [RFC3261-8.2-36]
- * P-Called-Party-ID
 - A UAC MUST NOT insert a P-Called-Party-ID header field in any SIP request or response. [RFC3455-4.2-1]
- * Record-Route
 - When a UAS responds to a request with a response that establishes a dialog, the UAS MUST copy all Record-Route header field values from the request into the response. [RFC3261-12.1-2][RFC3261-12.1-9]
 - Record-Route header field values MUST maintain the order of Record-Route values from the request. [RFC3261-12.1-3][RFC3261-12.1-9]
- * To
 - If the To header field in the request did not contain a tag, the URI in the To header field in the response MUST equal the URI in the To header field. [RFC3261-8.2-42]
 - If the To header field in the request did not contain a tag, the UAS MUST add a tag to the To header field in the response. [RFC3261-8.2-43]
 - The same tag MUST be used for all responses to that request, both final and provisional. [RFC3261-8.2-44]
- * Via
 - The Via header field values in the response MUST equal the Via header field values in the request and MUST maintain the same ordering. [RFC3261-8.2-39][RFC3261-8.2-40]
 - If the host portion of the "sent-by" parameter contains a domain name, or if it contains an IP address that differs from the packet source address, the server MUST add a "received" parameter to that



Via header field value.[RFC3261-18.2-5]

-The "received" parameter MUST contain the source address from which the packet was received.[RFC3261-18.2-6]

-The response MUST be sent to the address in the "received" parameter, using the port indicated in the "sent-by" value, or using port 5060 if none is specified explicitly.[RFC3261-18.2-13]

- Bodies fields:

-The SDP payloads SHALL not be encrypted.[TS24229-6.1-1]

-Only SDP payload SHALL be contained in SIP messages when the SDP payload must be included in the message.[TS24229-6.1-3]

-The answer MUST be in a reliable non-failure message from UAS back to UAC which is correlated to that INVITE if the initial offer is in an INVITE.
[RFC3261-13.2-6][RFC3261-13.3-11]

-The Session Description Protocol MUST be supported by all user agents as a means to describe sessions.[RFC3261-13.2-12]

-Whitespace MUST NOT be used on either side of the "=" sign. [RFC4566-5-2]

-v,o,s,(c),t,m,(c) lines are REQUIRED in the SDP message.

(c line MUST include session level information or all of media information)

[RFC4566-5-3]

-all MUST appear in exactly the following order:

"v,o,s,(i),(u),(e),(p),(c),(b),t,(r),(z),(k),(a),m,(i),(c),(b),(k),(a)"

(the line enclosed in "()" is OPTIONAL)[RFC4566-5-4]

* o line

-For both IP4 and IP6, the fully qualified domain name is the form that SHOULD be given unless this is unavailable, in which case the globally unique address MAY be substituted.[RFC4566-5.2-3]

* s line

-There MUST be one and only one "s=" field per session description.
[RFC4566-5.3-1]

-The "s=" field MUST NOT be empty. [RFC4566-5.3-2]

-If a session has no meaningful name, the value "s=" SHOULD be used.
[RFC4566-5.3-4]

* c line

-A session description MUST contain either at least one "c=" field in each media description or a single "c=" field at the session level.
[RFC4566-5.7-1]

-A session-level "c=" field MUST NOT specify Multiple addresses or



"c=" lines.[RFC4566-5.7-7]

* b line

-The proposed bandwidth for each media stream utilizing the "b=" media descriptor and the "AS" bandwidth modifier in the SDP SHALL be specified for "video" and "audio" media types that utilize the RTP/RTCP.[TS24229-6.1-7]

3.12 generic_ACK

Generic judgement items for ACK request.

See generic_sip_message

-The empty line MUST be present even if the message-body is not. [RFC3261-7-2]

- Request-Line:

-The Request-URI MUST NOT contain unescaped space control characters. [RFC3261-7.1-1]

-The Request-URI MUST NOT be enclosed in "<>". [RFC3261-7.1-2]

-The UAC MUST place the remote target URI into the Request-URI if the route set is not empty and the first URI in the route set contains the lr parameter.[RFC3261-12.2-14]

- Header fields:

-SIP request MUST contain To, From, CSeq, Call-ID, Max-Forwards, and Via header fields. [RFC3261-8.1-1]

* Call-ID

-The Call-ID header field MUST be the same for all requests and responses sent by either UA in a dialog.[RFC3261-8.1-10]

-The Call-ID of the request MUST be set to the Call-ID of the dialog. [RFC3261-12.2-6]

* Content-length

-If no body is present in a message, then the Content-Length header field value MUST be set to zero.[RFC3261-20.14-3]

* CSeq



- The Cseq method MUST match the method of Request-Line in the request. [RFC3261-8.1-14][RFC3261-12.2-11]
- The sequence number value in the CSeq header field MUST be expressible as a 32-bit unsigned integer. [RFC3261-8.1-15][RFC3261-20.16-1]
- The sequence number value in the CSeq header field MUST be less than $2^{*}31$. [RFC3261-8.1-16]
- The sequence number of the CSeq header field MUST be the same as the INVITE being acknowledged. [RFC3261-13.2-19]
- The CSeq method MUST be ACK. [RFC3261-13.2-20]

* From

- The From URI of the request MUST be set to the local URI from the dialog state. [RFC3261-12.2-3]
- The tag in the From header field of the request MUST be set to the local tag of the dialog ID. [RFC3261-12.2-4]

* Max-Forwards

- A UAC MUST insert a Max-Forwards header field into each request it originates. [RFC3261-8.1-17]
- The Max-Forwards header field value SHOULD be 70. [RFC3261-8.1-18]

* P-Called-Party-ID

- A UAC MUST NOT insert a P-Called-Party-ID header field in any SIP request or response. [RFC3455-4.2-1]

* Route

- If the request contains a Route header field, the request SHOULD be sent to the locations derived from its topmost value. [RFC3261-8.1-38]
- The UAC MUST include a Route header field containing the route set values in order including all parameters if the route set is not empty, and the first URI in the route set contains the lr parameter. [RFC3261-12.2-15]

* To

- The URI in the To field of the request MUST be set to the remote URI from the dialog state. [RFC3261-12.2-1]
- The tag in the To header field of the request MUST be set to the remote tag of the dialog ID. [RFC3261-12.2-2]

* Via

- A UAC MUST insert a Via into that request. [RFC3261-8.1-19]
- The protocol name and protocol version in the Via header field MUST



be SIP and 2.0. [RFC3261-8.1-20]

-The Via header field value **MUST** contain a branch parameter.
[RFC3261-8.1-21]

-The branch ID **MUST** always begin with the characters "z9hG4bK".
[RFC3261-8.1-23]

-The client transport **MUST** insert a value of the "sent-by" field
into the Via header field.[RFC3261-18.1-7]

[AKA]

-The protected server port and the respective contact address **SHALL** be
included in the Via header entry relating to the UE if the has not obtained
a GRUU and IMS AKA is being used.[TS24229-5.1-356]

[Digest]

-UE **SHALL** populate the Via header field of the request with the port value of
an unprotected port and the respective contact address where the UE expects
to receive responses to the request if the has not obtained a GRUU and
SIP digest without TLS is being used.[TS24229-5.1-358]

3.13 generic_BYE

Generic judgement items for BYE request.

See generic_sip_message

-The empty line **MUST** be present even if the message-body is not. [RFC3261-7-2]

- Request-Line:

-The Request-URI **MUST NOT** contain unescaped space control characters.
[RFC3261-7.1-1]

-The Request-URI **MUST NOT** be enclosed in "<>". [RFC3261-7.1-2]

-The UAC **MUST** place the remote target URI into the Request-URI if the
route set is not empty and the first URI in the route set contains the
lr parameter.[RFC3261-12.2-14]

- Header fields:

-SIP request **MUST** contain To, From, CSeq, Call-ID, Max-Forwards, and Via
header fields. [RFC3261-8.1-1]

[AKA]

-These requests **MUST** also have both a Require and Proxy-Require header
fields with the value "sec-agree".[RFC3329-2.3-16]



[Digest]

-Security-Client, Security-Verify header field and both a Require and Proxy-Require header fields with the value "sec-agree" SHALL not be included in any SIP messages if SIP digest without TLS is used.[TS24229-5.1-363]

* Call-ID

- The Call-ID header field MUST be the same for all requests and responses sent by either UA in a dialog.[RFC3261-8.1-10]
- The Call-ID of the request MUST be set to the Call-ID of the dialog.[RFC3261-12.2-6]

* Content-length

- If no body is present in a message, then the Content-Length header field value MUST be set to zero.[RFC3261-20.14-3]

* CSeq

- The Cseq method MUST match the method of Request-Line in the request.[RFC3261-8.1-14][RFC3261-12.2-11]
- The sequence number value in the CSeq header field MUST be expressible as a 32-bit unsigned integer. [RFC3261-8.1-15][RFC3261-20.16-1]
- The sequence number value in the CSeq header field MUST be less than 2^{31} . [RFC3261-8.1-16]
- Requests within a dialog MUST contain strictly monotonically increasing and contiguous CSeq sequence numbers in each direction. [RFC3261-12.2-7]
- The value of the local sequence number MUST be incremented by one if the local sequence number is not empty.[RFC3261-12.2-8]
- The value of the local sequence number that be incremented by one MUST be placed into the CSeq header field if the local sequence number is not empty.[RFC3261-12.2-9]

* From

- The From URI of the request MUST be set to the local URI from the dialog state.[RFC3261-12.2-3]
- The tag in the From header field of the request MUST be set to the local tag of the dialog ID.[RFC3261-12.2-4]

* Max-Forwards

- A UAC MUST insert a Max-Forwards header field into each request it originates. [RFC3261-8.1-17]
- The Max-Forwards header field value SHOULD be 70.[RFC3261-8.1-18]



* P-Called-Party-ID

-A UAC MUST NOT insert a P-Called-Party-ID header field in any SIP request or response.[RFC3455-4.2-1]

* Route

-If the request contains a Route header field, the request SHOULD be sent to the locations derived from its topmost value.[RFC3261-8.1-38]

-The UAC MUST include a Route header field containing the route set values in order including all parameters if the route set is not empty, and the first URI in the route set contains the lr parameter. [RFC3261-12.2-15]

* Security-Verify [AKA]

-A subsequent SIP requests MUST contain a Security-Verify header field that mirrors the server's list received previously in the Security- Server header field.[RFC3329-2.3-15]

* To

-The URI in the To field of the request MUST be set to the remote URI from the dialog state.[RFC3261-12.2-1]

-The tag in the To header field of the request MUST be set to the remote tag of the dialog ID.[RFC3261-12.2-2]

* Via

-A UAC MUST insert a Via into that request. [RFC3261-8.1-19]

-The protocol name and protocol version in the Via header field MUST be SIP and 2.0. [RFC3261-8.1-20]

-The Via header field value MUST contain a branch parameter. [RFC3261-8.1-21]

-The branch ID MUST always begin with the characters "z9hG4bK". [RFC3261-8.1-23]

-The client transport MUST insert a value of the "sent-by" field into the Via header field.[RFC3261-18.1-7]

[AKA]

-The protected server port and the respective contact address SHALL be included in the Via header entry relating to the UE if the has not obtained a GRUU and IMS AKA is being used.[TS24229-5.1-356]

[Digest]

-UE SHALL populate the Via header field of the request with the port value of an unprotected port and the respective contact address where the UE expects to receive responses to the request if the has not obtained a GRUU and



SIP digest without TLS is being used.[TS24229-5.1-358]

- Security Association behavior [AKA]
 - All the subsequent SIP requests sent by the client to that server SHOULD make use of the security mechanism initiated in the previous step.[RFC3329-2.3-14]

3.14 generic_200-BYE

Generic judgement items for 200-BYE response.

See generic_sip_message

- The empty line MUST be present even if the message-body is not. [RFC3261-7-2]
- TUs SHOULD respond immediately to non-INVITE requests.[RFC3261-17.1-1]

- Header fields:

* Call-ID

- The Call-ID header field MUST be the same for all requests and responses sent by either UA in a dialog.[RFC3261-8.1-10]
- The Call-ID header field of the response MUST equal the Call-ID header field of the request.[RFC3261-8.2-37]

* Content-length

- If no body is present in a message, then the Content-Length header field value MUST be set to zero.[RFC3261-20.14-3]

* CSeq

- The CSeq header field of the response MUST equal the CSeq field of the request.[RFC3261-8.2-38]

* From

- The From field of the response MUST equal the From header field of the request.[RFC3261-8.2-36]

* P-Called-Party-ID

- A UAC MUST NOT insert a P-Called-Party-ID header field in any SIP request or response.[RFC3455-4.2-1]

* To



- If a request contained a To tag in the request, the To header field in the response MUST equal that of the request.[RFC3261-8.2-41]
- The same tag MUST be used for all responses to that request, both final and provisional. [RFC3261-8.2-44]

* Via

- The Via header field values in the response MUST equal the Via header field values in the request and MUST maintain the same ordering. [RFC3261-8.2-39][RFC3261-8.2-40]
- If the host portion of the "sent-by" parameter contains a domain name, or if it contains an IP address that differs from the packet source address, the server MUST add a "received" parameter to that Via header field value.[RFC3261-18.2-5]
- The "received" parameter MUST contain the source address from which the packet was received.[RFC3261-18.2-6]
- The response MUST be sent to the address in the "received" parameter, using the port indicated in the "sent-by" value, or using port 5060 if none is specified explicitly.[RFC3261-18.2-13]

3.15 generic_CANCEL

Generic judgement items for CANCEL request.

See generic_sip_message

- The empty line MUST be present even if the message-body is not. [RFC3261-7-2]
- The Request-URI, Call-ID, To, the numeric part of CSeq, and From header fields in the CANCEL request MUST be identical to those in the request being cancelled, including tags.[RFC3261-9.1-2]
- The destination address, port, and transport for the CANCEL MUST be identical to those used to send the original request.[RFC3261-9.1-11]
- Request-Line:
 - The Request-URI MUST NOT contain unescaped space control characters. [RFC3261-7.1-1]
 - The Request-URI MUST NOT be enclosed in "<>". [RFC3261-7.1-2]
- Header fields:
 - SIP request MUST contain To, From, CSeq, Call-ID, Max-Forwards, and Via



header fields. [RFC3261-8.1-1]

-Require and Proxy-Require MUST NOT be used in a SIP CANCEL request, or in an ACK request sent for a non-2xx response.

[RFC3261-8.2-18][RFC3261-9.1-6]

[Digest]

-Security-Client, Security-Verify header field and both a Require and Proxy-Require header fields with the value "sec-agree" SHALL not be included in any SIP messages if SIP digest without TLS is used.[TS24229-5.1-363]

* Content-length

-If no body is present in a message, then the Content-Length header field value MUST be set to zero.[RFC3261-20.14-3]

* CSeq

-The sequence number value in the CSeq header field MUST be expressible as a 32-bit unsigned integer. [RFC3261-8.1-15][RFC3261-20.16-1]

-The sequence number value in the CSeq header field MUST be less than $2^{**}31$. [RFC3261-8.1-16]

-The CSeq method MUST have a value of CANCEL. [RFC3261-9.1-4]

* Max-Forwards

-A UAC MUST insert a Max-Forwards header field into each request it originates. [RFC3261-8.1-17]

-The Max-Forwards header field value SHOULD be 70.[RFC3261-8.1-18]

* P-Called-Party-ID

-A UAC MUST NOT insert a P-Called-Party-ID header field in any SIP request or response.[RFC3455-4.2-1]

* Route

-If the request being cancelled contains a Route header field, the CANCEL request MUST include that Route header field's values. [RFC3261-9.1-5]

* Via

-A UAC MUST insert a Via into that request. [RFC3261-8.1-19]

-The protocol name and protocol version in the Via header field MUST be SIP and 2.0. [RFC3261-8.1-20]

-The Via header field value MUST contain a branch parameter. [RFC3261-8.1-21]

-The branch ID MUST always begin with the characters "z9hG4bK". [RFC3261-8.1-23]



-A CANCEL constructed by a client MUST have only a single Via header field value matching the top Via value in the request being cancelled.

[RFC3261-9.1-3]

[AKA]

-The protected server port and the respective contact address SHALL be included in the Via header entry relating to the UE if the has not obtained a GRUU and IMS AKA is being used.[TS24229-5.1-356]

[Digest]

-UE SHALL populate the Via header field of the request with the port value of an unprotected port and the respective contact address where the UE expects to receive responses to the request if the has not obtained a GRUU and SIP digest without TLS is being used.[TS24229-5.1-358]

3.16 generic_200-CANCEL

Generic judgement items for 200-CANCEL response.

See generic_sip_message

-The empty line MUST be present even if the message-body is not. [RFC3261-7-2]

-TUs SHOULD respond immediately to non-INVITE requests.[RFC3261-17.1-1]

- Header fields:

* Call-ID

-The Call-ID header field of the response MUST equal the Call-ID header field of the request.[RFC3261-8.2-37]

* Content-length

-If no body is present in a message, then the Content-Length header field value MUST be set to zero.[RFC3261-20.14-3]

* CSeq

-The CSeq header field of the response MUST equal the CSeq field of the request.[RFC3261-8.2-38]

* From

-The From field of the response MUST equal the From header field of the request.[RFC3261-8.2-36]

* P-Called-Party-ID



-A UAC MUST NOT insert a P-Called-Party-ID header field in any SIP request or response.[RFC3455-4.2-1]

* To

-If the To header field in the request did not contain a tag, the URI in the To header field in the response MUST equal the URI in the To header field. [RFC3261-8.2-42]

-If the To header field in the request did not contain a tag, the UAS MUST add a tag to the To header field in the response. [RFC3261-8.2-43]

* Via

-The Via header field values in the response MUST equal the Via header field values in the request and MUST maintain the same ordering. [RFC3261-8.2-39][RFC3261-8.2-40]

-If the host portion of the "sent-by" parameter contains a domain name, or if it contains an IP address that differs from the packet source address, the server MUST add a "received" parameter to that Via header field value.[RFC3261-18.2-5]

-The "received" parameter MUST contain the source address from which the packet was received.[RFC3261-18.2-6]

-The response MUST be sent to the address in the "received" parameter, using the port indicated in the "sent-by" value, or using port 5060 if none is specified explicitly.[RFC3261-18.2-13]

3.17 generic_3XX-6XX

Generic judgement items for 3XX-6XX response.

See generic_sip_message

-The empty line MUST be present even if the message-body is not. [RFC3261-7-2]

- Header fields:

* Call-ID

-The Call-ID header field of the response MUST equal the Call-ID header field of the request.[RFC3261-8.2-37]

* Content-length

-If no body is present in a message, then the Content-Length header



field value **MUST** be set to zero.[RFC3261-20.14-3]

* CSeq

-The CSeq header field of the response **MUST** equal the CSeq field of the request.[RFC3261-8.2-38]

* From

-The From field of the response **MUST** equal the From header field of the request.[RFC3261-8.2-36]

* P-Called-Party-ID

-A UAC **MUST NOT** insert a P-Called-Party-ID header field in any SIP request or response.[RFC3455-4.2-1]

* To

-If a request contained a To tag in the request, the To header field in the response **MUST** equal that of the request.[RFC3261-8.2-41]

-If the To header field in the request did not contain a tag, the URI in the To header field in the response **MUST** equal the URI in the To header field. [RFC3261-8.2-42]

-If the To header field in the request did not contain a tag, the UAS **MUST** add a tag to the To header field in the response. [RFC3261-8.2-43]

-The same tag **MUST** be used for all responses to that request, both final and provisional. [RFC3261-8.2-44]

* Via

-The Via header field values in the response **MUST** equal the Via header field values in the request and **MUST** maintain the same ordering. [RFC3261-8.2-39][RFC3261-8.2-40]

-If the host portion of the "sent-by" parameter contains a domain name, or if it contains an IP address that differs from the packet source address, the server **MUST** add a "received" parameter to that Via header field value.[RFC3261-18.2-5]

-The "received" parameter **MUST** contain the source address from which the packet was received.[RFC3261-18.2-6]

-The response **MUST** be sent to the address in the "received" parameter, using the port indicated in the "sent-by" value, or using port 5060 if none is specified explicitly.[RFC3261-18.2-13]

3.18 generic_ACK-non2XX



Generic judgement items for ACK-non2XX request.

See generic_sip_message

- The empty line MUST be present even if the message-body is not. [RFC3261-7-2]
- The ACK MUST be sent to the same address, port, and transport to which the original request was sent.[RFC3261-17.1-23]
- The ACK request constructed by the client transaction MUST contain values for the Call-ID, From, and Request-URI that are equal to the values of those header fields in the request passed to the transport by the client transaction. [RFC3261-17.1-32]

- Request-Line:

- The Request-URI MUST NOT contain unescaped space control characters. [RFC3261-7.1-1]
- The Request-URI MUST NOT be enclosed in "<>". [RFC3261-7.1-2]

- Header fields:

- SIP request MUST contain To, From, CSeq, Call-ID, Max-Forwards, and Via header fields. [RFC3261-8.1-1]
- Require and Proxy-Require MUST NOT be used in a SIP CANCEL request, or in an ACK request sent for a non-2xx response. [RFC3261-8.2-18]

* Content-length

- If no body is present in a message, then the Content-Length header field value MUST be set to zero.[RFC3261-20.14-3]

* CSeq

- The Cseq method MUST match the method of Request-Line in the request. [RFC3261-8.1-14]
- The sequence number value in the CSeq header field MUST be expressible as a 32-bit unsigned integer. [RFC3261-8.1-15][RFC3261-20.16-1]
- The sequence number value in the CSeq header field MUST be less than 2^{31} . [RFC3261-8.1-16]
- The CSeq header field in the ACK MUST contain the same value for the sequence number as was present in the original request. [RFC3261-17.1-36]
- The method parameter MUST be equal to "ACK".[RFC3261-17.1-37]

* Max-Forwards



- A UAC MUST insert a Max-Forwards header field into each request it originates.[RFC3261-8.1-17]
- The Max-Forwards header field value SHOULD be 70.[RFC3261-8.1-18]

* P-Called-Party-ID

- A UAC MUST NOT insert a P-Called-Party-ID header field in any SIP request or response.[RFC3455-4.2-1]

* Route

- The Route header fields MUST appear in the ACK if the INVITE request whose response is being acknowledged had Route header fields.
[RFC3261-17.1-38]

* To

- The To header field in the ACK MUST equal the To header field in the response being acknowledged.[RFC3261-17.1-33]

* Via

- A UAC MUST insert a Via into that request. [RFC3261-8.1-19]
- The protocol name and protocol version in the Via header field MUST be SIP and 2.0. [RFC3261-8.1-20]
- The Via header field value MUST contain a branch parameter.
[RFC3261-8.1-21]
- The branch ID MUST always begin with the characters "z9hG4bK".
[RFC3261-8.1-23]
- The ACK MUST contain a single Via header field.[RFC3261-17.1-34]
- The single Via header field MUST be equal to the top Via header field of the original request.[RFC3261-17.1-35]

[AKA]

- The protected server port and the respective contact address SHALL be included in the Via header entry relating to the UE if the has not obtained a GRUU and IMS AKA is being used.[TS24229-5.1-356]

[Digest]

- UE SHALL populate the Via header field of the request with the port value of an unprotected port and the respective contact address where the UE expects to receive responses to the request if the has not obtained a GRUU and SIP digest without TLS is being used.[TS24229-5.1-358]

3.19 generic_OPTIONS

Generic judgement items for OPTIONS request.



See `generic_sip_message`

-The empty line **MUST** be present even if the message-body is not. [RFC3261-7-2]

- Request-Line:

-The Request-URI **MUST NOT** contain unescaped space control characters.
[RFC3261-7.1-1]

-The Request-URI **MUST NOT** be enclosed in "<>". [RFC3261-7.1-2]

-The initial Request-URI of the message **SHOULD** be set to the value of the URI in the To field.[RFC3261-8.1-2]

- Header fields:

-SIP request **MUST** contain To, From, CSeq, Call-ID, Max-Forwards, and Via header fields. [RFC3261-8.1-1]

[AKA]

-These requests **MUST** also have both a Require and Proxy-Require header fields with the value "sec-agree".[RFC3329-2.3-16]

[Digest]

-Security-Client, Security-Verify header field and both a Require and Proxy-Require header fields with the value "sec-agree" **SHALL** not be included in any SIP messages if SIP digest without TLS is used.[TS24229-5.1-363]

* Accept

-An Accept header field **SHOULD** be included to indicate the type of message body the UAC wishes to receive in the response.
[RFC3261-11.1-1]

* Content-length

-If no body is present in a message, then the Content-Length header field value **MUST** be set to zero.[RFC3261-20.14-3]

* CSeq

-The Cseq method **MUST** match the method of Request-Line in the request.
[RFC3261-8.1-14]

-The sequence number value in the CSeq header field **MUST** be expressible as a 32-bit unsigned integer. [RFC3261-8.1-15][RFC3261-20.16-1]

-The sequence number value in the CSeq header field **MUST** be less than $2^{*}31$. [RFC3261-8.1-16]



* From

-The From field MUST contain a new "tag" parameter, chosen by the UAC.
[RFC3261-8.1-9]

* Max-Forwards

-A UAC MUST insert a Max-Forwards header field into each request it originates. [RFC3261-8.1-17]
-The Max-Forwards header field value SHOULD be 70. [RFC3261-8.1-18]

* P-Called-Party-ID

-A UAC MUST NOT insert a P-Called-Party-ID header field in any SIP request or response. [RFC3455-4.2-1]

* P-Preferred-Identity

-The P-Preferred-Identity header field SHALL be used as the public user identity for the request if a P-Preferred-Identity was included.
[TS24229-5.1-378]

[AKA]

-The default public user identity for the security association SHALL be used as the public user identity for the request if no P-Preferred-Identity was included. [TS24229-5.1-379]

* Route

-A proper preloaded Route header value SHALL be built in Route header for all new dialog and standalone transactions. [TS24229-5.1-398]

-A list of Route header values made out of the P-CSCF URI containing the IP address or the FQDN learnt through the P-CSCF discovery procedure SHALL be built in Route header. [TS24229-5.1-400]

-A list of Route header values made out of the values received in the Service-Route header field saved from the 200 (OK) response to the last registration or re-registration of the public user identity with associated contact address SHALL be built in Route header.
[TS24229-5.1-404]

-If the request contains a Route header field, the request SHOULD be sent to the locations derived from its topmost value. [RFC3261-8.1-38]

[AKA]

-A list of Route header values made out of the P-CSCF port containing the protected server port learned during the registration procedure SHALL be built in Route header. [TS24229-5.1-402]

[Digest]

-A list of Route header values made out of the P-CSCF port containing the unprotected server port learned during the registration procedure



SHALL be built in Route header. [TS24229-5.1-403]

* Security-Verify [AKA]

-A subsequent SIP requests MUST contain a Security-Verify header field that mirrors the server's list received previously in the Security- Server header field.[RFC3329-2.3-15]

* To

-A request outside of a dialog MUST NOT contain a To tag. [RFC3261-8.1-7]

* Via

-A UAC MUST insert a Via into that request. [RFC3261-8.1-19]

-The protocol name and protocol version in the Via header field MUST be SIP and 2.0. [RFC3261-8.1-20]

-The Via header field value MUST contain a branch parameter. [RFC3261-8.1-21]

-The branch ID MUST always begin with the characters "z9hG4bK". [RFC3261-8.1-23]

-The client transport MUST insert a value of the "sent-by" field into the Via header field.[RFC3261-18.1-7]

[AKA]

-The protected server port and the respective contact address SHALL be included in the Via header entry relating to the UE if the has not obtained a GRUU and IMS AKA is being used.[TS24229-5.1-356]

[Digest]

-UE SHALL populate the Via header field of the request with the port value of an unprotected port and the respective contact address where the UE expects to receive responses to the request if the has not obtained a GRUU and SIP digest without TLS is being used.[TS24229-5.1-358]

- Security Association behavior [AKA]

-All the subsequent SIP requests sent by the client to that server SHOULD make use of the security mechanism initiated in the previous step.[RFC3329-2.3-14]

3.20 generic_200-OPTIONS

Generic judgement items for 200-OPTIONS response.

See generic_sip_message



-TUs SHOULD respond immediately to non-INVITE requests.[RFC3261-17.1-1]

- Header fields:

-Allow, Accept, Accept-Encoding, Accept-Language, and Supported header fields SHOULD be present in a 200 (OK) response to an OPTIONS request.
[RFC3261-11.2-2]

* Allow

-All UAs MUST support the OPTIONS method.[RFC3261-11-1]
-A UA that supports INVITE MUST also support ACK, CANCEL and BYE.
[RFC3261-13.1-1]

* Allow-Events

-Any node implementing one or more event packages SHOULD include an appropriate "Allow-Events" header indicating all supported events in all methods which initiate dialogs and their responses and OPTIONS responses.[RFC3265-3.3-5]

* Call-ID

-The Call-ID header field of the response MUST equal the Call-ID header field of the request.[RFC3261-8.2-37]

* Content-Encoding

-If the body has not undergone any encoding such as compression, then Content-Encoding MUST be omitted. [RFC3261-7.4-3]

* Content-Type

-The Internet media type of the message body MUST be given by the Content-Type header field.[RFC3261-7.4-1]
-The Content-Type header field MUST be present if the body is not empty.[RFC3261-20.15-1]

* CSeq

-The CSeq header field of the response MUST equal the CSeq field of the request.[RFC3261-8.2-38]

* From

-The From field of the response MUST equal the From header field of the request.[RFC3261-8.2-36]



* P-Called-Party-ID

-A UAC MUST NOT insert a P-Called-Party-ID header field in any SIP request or response.[RFC3455-4.2-1]

* To

-If the To header field in the request did not contain a tag, the URI in the To header field in the response MUST equal the URI in the To header field.[RFC3261-8.2-42]

-If the To header field in the request did not contain a tag, the UAS MUST add a tag to the To header field in the response. [RFC3261-8.2-43]

* Via

-The Via header field values in the response MUST equal the Via header field values in the request and MUST maintain the same ordering.[RFC3261-8.2-39][RFC3261-8.2-40]

-If the host portion of the "sent-by" parameter contains a domain name, or if it contains an IP address that differs from the packet source address, the server MUST add a "received" parameter to that Via header field value.[RFC3261-18.2-5]

-The "received" parameter MUST contain the source address from which the packet was received.[RFC3261-18.2-6]

-The response MUST be sent to the address in the "received" parameter, using the port indicated in the "sent-by" value, or using port 5060 if none is specified explicitly.[RFC3261-18.2-13]

- Bodies fields:

-The SDP payloads SHALL not be encrypted.[TS24229-6.1-1]

-Only SDP payload SHALL be contained in SIP messages when the SDP payload must be included in the message.[TS24229-6.1-3]

-If the types include one that can describe media capabilities, the UAS SHOULD include a body in the response for that purpose. [RFC3261-11.2-4]

-The Session Description Protocol MUST be supported by all user agents as a means to describe sessions.[RFC3261-13.2-12]

-Whitespace MUST NOT be used on either side of the "=" sign. [RFC4566-5-2]

-v,o,s,(c),t,m,(c) lines are REQUIRED in the SDP message.

(c line MUST include session level information or all of media information) [RFC4566-5-3]

-all MUST appear in exactly the following order:

"v,o,s,(i),(u),(e),(p),(c),(b),t,(r),(z),(k),(a),m,(i),(c),(b),(k),(a)"

(the line enclosed in "()" is OPTIONAL)[RFC4566-5-4]



* o line

-For both IP4 and IP6, the fully qualified domain name is the form that SHOULD be given unless this is unavailable, in which case the globally unique address MAY be substituted.[RFC4566-5.2-3]

* s line

-There MUST be one and only one "s=" field per session description.
[RFC4566-5.3-1]

-The "s=" field MUST NOT be empty. [RFC4566-5.3-2]

-If a session has no meaningful name, the value "s=" SHOULD be used.
[RFC4566-5.3-4]

* c line

-A session description MUST contain either at least one "c=" field in each media description or a single "c=" field at the session level.
[RFC4566-5.7-1]

-A session-level "c=" field MUST NOT specify Multiple addresses or "c=" lines.[RFC4566-5.7-7]

* b line

-The proposed bandwidth for each media stream utilizing the "b=" media descriptor and the "AS" bandwidth modifier in the SDP SHALL be specified for "video" and "audio" media types that utilize the RTP/RTCP.[TS24229-6.1-7]



4 Test Profile: User Equipment operation (IMS-AKA)

4.1 Registration

4.1.1 UE-RG-B-1-AKA - Initial registration and subscription for the registration state event package (SIP default port values)

[NAME]

UE-RG-B-1-AKA - Initial registration and subscription for the registration state event package (SIP default port values)

[TARGET]

IMS User Equipment (NUT)

[PURPOSE]

- (1) To verify that the UEa1 properly sends the initial REGISTER request to the SIP default port values and registers its public user identity when the UEa1 does not receive any specific port information during the P-CSCF discovery procedure, or if the UE was pre-configured with the P-CSCF's IP address or domain name and was unable to obtain specific port information.
- (2) To verify that the UEa1 properly subscribes to the reg event package for the public user identity registered at the user's registrar and performs upon receipt of a NOTIFY request on the dialog which was generated during subscription to the reg event package.

[REFERENCE]

TS24.229 5.1.1.1
TS24.229 5.1.1.2.1
TS24.229 5.1.1.2.2
TS24.229 5.1.1.3
TS24.229 5.1.1.5.1
TS33.203 6
RFC3680 4.6
RFC3680 7

[REQUIREMENT]



NONE

[PARAMETER(NUT)]

```

public-user-id      :      sip:UEa1_public_1@under.test.com
private-user-id    :      UEa1_private@under.test.com
contact_URI        :      sip:UEa1_public_1@node.under.test.com
HOMENETWORK Domain :      sip:under.test.com

```

[PARAMETER(TESTER)]

```

P-CSCFa1          :      sip:p.a1.under.test.com
S-CSCFa1          :      sip:s.a1.under.test.com

```

[ADDRESS]

```

UEa1(NUT)         :      3ffe:501:fff:1000::1000
Router(R1)        :      3ffe:501:fff:1000::1
P-CSCFa1          :      3ffe:501:fff:100::10
I-CSCFa1          :      3ffe:501:fff:100::20
S-CSCFa1          :      3ffe:501:fff:100::30
DNS                :      3ffe:501:fff:100::40
DHCP              :      3ffe:501:fff:100::50

```

[TOPOLOGY]

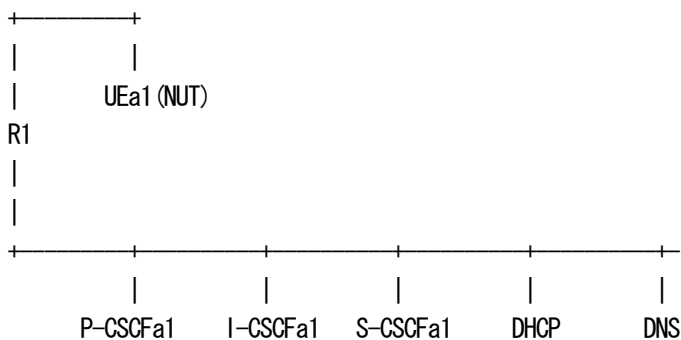

[INITIALIZATION]

Set up IP Address using A or B.

A. Router Advertisement

B. DHCPv6



(NUT)

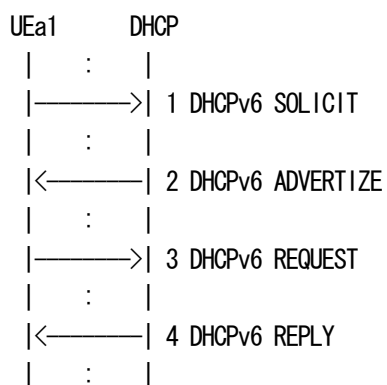

[PROCEDURE]

Home Network

(NUT)

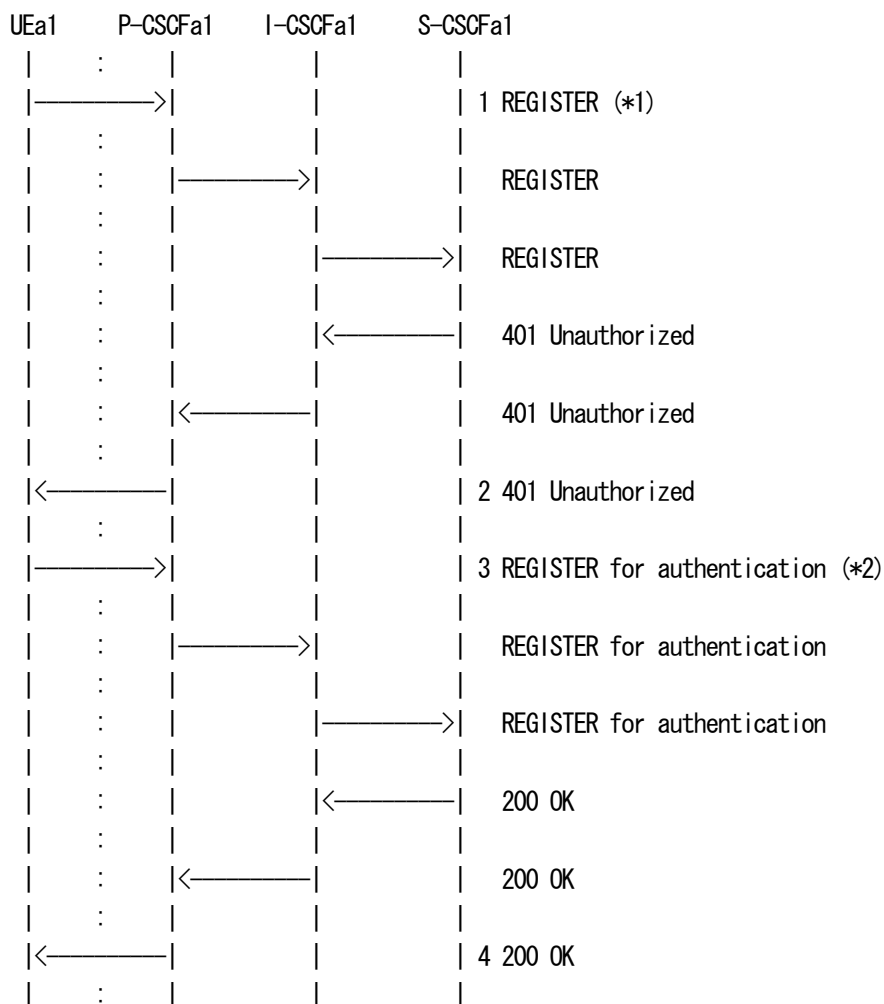

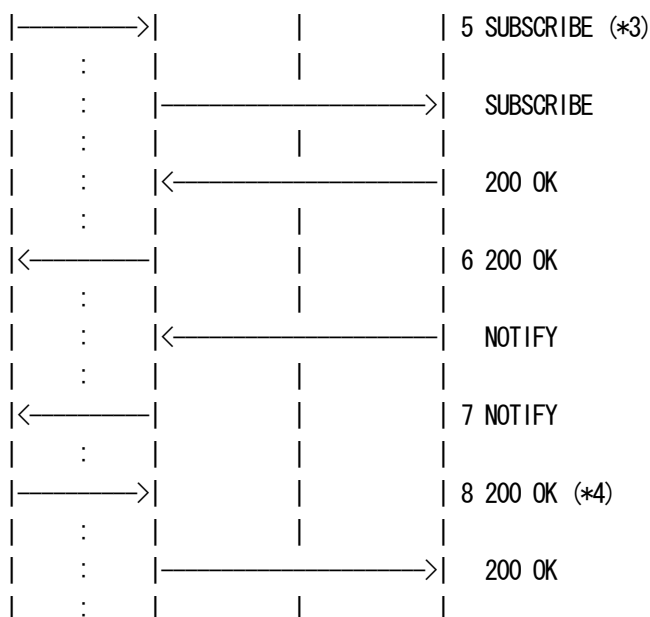

- 1 NUT sends REGISTER
- 2 NUT receives 401 Unauthorized
- 3 NUT sends REGISTER for authentication
- 4 NUT receives 200 OK
- 5 NUT sends SUBSCRIBE
- 6 NUT receives 200 OK
- 7 NUT receives NOTIFY
- 8 NUT sends 200 OK

=== Message example ===

1. REGISTER NUT -> P-CSCF

```

REGISTER sip:under.test.com SIP/2.0
Via: SIP/2.0/UDP [3ffe:501:ffff:1000::1000]:5060;branch=z9hG4bKnashds7
Max-Forwards: 70
From: <sip:UEa1_public_1@under.test.com>;tag=4fa3
To: <sip:UEa1_public_1@under.test.com>
Contact: <sip:UEa1_public_1@node.under.test.com>;expires=600000
Call-ID: apb03a0s09dkjdfgkjl49111@under.test.com
Authorization: Digest username="UEa1_private@under.test.com", realm="under.test.com",
nonce="", uri="sip:under.test.com", response=""
Security-Client: ipsec-3gpp; mode="trans"; alg=hmac-sha-1-96; spi-c=23456789; spi-s=12345678;
port-c=2468; port-s=1357
Require: sec-agree
Proxy-Require: sec-agree
CSeq: 1 REGISTER
  
```



Supported: path
Content-Length: 0

2. 401 Unauthorized P-CSCF -> NUT

SIP/2.0 401 Unauthorized

Via: SIP/2.0/UDP [3ffe:501:ffff:1000::1000]:5060;branch=z9hG4bKnashds7

WWW-Authenticate: Digest realm="under.test.com", nonce="11U8vpY3qJhiuZnrke/

NaponGSCcLm5iR+WCRkWYoM", algorithm=AKAv1-MD5

From: <sip:UEa1_public_1@under.test.com>;tag=4fa3

To: <sip:UEa1_public_1@under.test.com>;tag=5ef4

Call-ID: apb03a0s09dkjdfglkj49111@under.test.com

Security-Server: ipsec-3gpp; alg=hmac-sha-1-96; spi-c=256; spi-s=257; port-c=10002; port-s=10001

CSeq: 1 REGISTER

Content-Length: 0

3. REGISTER NUT -> P-CSCF

REGISTER sip:under.test.com SIP/2.0

Via: SIP/2.0/UDP [3ffe:501:ffff:1000::1000]:1357;branch=z9hG4bKnashds8

Max-Forwards: 70

From: <sip:UEa1_public_1@under.test.com>;tag=4fa3

To: <sip:UEa1_public_1@under.test.com>

Contact: <sip:UEa1_public_1@node.under.test.com:1357>;expires=600000

Call-ID: apb03a0s09dkjdfglkj49111@under.test.com

Authorization: Digest username="UEa1_private@under.test.com", realm="under.test.com",
algorithm=AKAv1-MD5, nonce="11U8vpY3qJhiuZnrke/NaponGSCcLm5iR+WCRkWYoM",
uri="sip:under.test.com", response="6629fae49393a05397450978507c4ef1"

Security-Client: ipsec-3gpp; mode="trans"; alg=hmac-sha-1-96; spi-c=23456789; spi-s=12345678;
port-c=2468; port-s=1357

Security-Verify: ipsec-3gpp; alg=hmac-sha-1-96; spi-c=256; spi-s=257; port-c=10002; port-s=10001

Require: sec-agree

Proxy-Require: sec-agree

CSeq: 2 REGISTER

Supported: path

Content-Length: 0

4. 200 OK P-CSCF -> NUT

SIP/2.0 200 OK

Via: SIP/2.0/UDP [3ffe:501:ffff:1000::1000]:1357;branch=z9hG4bKnashds8

From: <sip:UEa1_public_1@under.test.com>;tag=4fa3

To: <sip:UEa1_public_1@under.test.com>;tag=5ef5



Call-ID: apb03a0s09dkjdfglkj49111@under.test.com
Contact: <sip:UEa1_public_1@node.under.test.com:1357>;expires=600000
Path: <sip:term@p.a1.under.test.com;lr>
Service-Route: <sip:orig@s.a1.under.test.com;lr>
P-Associated-URI: <sip:UEa1_public_1@under.test.com>
CSeq: 2 REGISTER
Date: Wed, 11 July 2001 08:49:37 GMT
Content-Length: 0

5. SUBSCRIBE NUT -> P-CSCF

SUBSCRIBE sip:UEa1_public_1@under.test.com SIP/2.0
Via: SIP/2.0/UDP [3ffe:501:ffff:1000::1000]:1357;branch=z9hG4bKnashdsa1
Max-Forwards: 70
Route: <sip:p.a1.under.test.com:10001;lr>,<sip:orig@s.a1.under.test.com;lr>
From: <sip:UEa1_public_1@under.test.com>;tag=31415
To: <sip:UEa1_public_1@under.test.com>
Call-ID: b89rjhnedlrfjflslj40a222@under.test.com
Require: sec-agree
Proxy-Require: sec-agree
CSeq: 1 SUBSCRIBE
Allow-Events: reg
Event: reg
Security-Verify: ipsec-3gpp; alg=hmac-sha-1-96; spi-c=256; spi-s=257; port-c=10002; port-s=10001
Expires: 600000
Contact: <sip:UEa1_public_1@node.under.test.com:1357>
Content-Length: 0

6. 200 OK P-CSCF -> NUT

SIP/2.0 200 OK
Via: SIP/2.0/UDP [3ffe:501:ffff:1000::1000]:1357;branch=z9hG4bKnashdsa1
Record-Route: <sip:p.a1.under.test.com:10001;lr>
From: <sip:UEa1_public_1@under.test.com>;tag=31415
To: <sip:UEa1_public_1@under.test.com>;tag=151170
Call-ID: b89rjhnedlrfjflslj40a222@under.test.com
CSeq: 1 SUBSCRIBE
Allow-Events: reg
Expires: 600000
Contact: <sip:s.a1.under.test.com>
Content-Length: 0



7. NOTIFY P-CSCF -> NUT

NOTIFY sip:UEa1_public_1@node.under.test.com:1357 SIP/2.0
Via: SIP/2.0/UDP p.a1.under.test.com:10001;branch=z9hG4bK240f34.1,
SIP/2.0/UDP s.a1.under.test.com;branch=z9hG4bK332b23.1;received=3ffe:501:ffff:100::30
Max-Forwards: 69
From: <sip:UEa1_public_1@under.test.com>;tag=151170
To: <sip:UEa1_public_1@under.test.com>;tag=31415
Call-ID: b89rjhnedlrffflslj40a222@under.test.com
CSeq: 1 NOTIFY
Contact: <sip:s.a1.under.test.com>
Subscription-State: active;expires=600000
Event: reg
Content-Type: application/reginfo+xml
Content-Length: (...)

```
<?xml version="1.0"?>
<reginfo xmlns="urn:ietf:params:xml:ns:reginfo" version="0" state="full">
  <registration aor="sip:UEa1_public_1@under.test.com" id="a7" state="active">
    <contact id="76" state="active" event="registered">
      <uri>sip:UEa1_public_1@node.under.test.com</uri>
    </contact>
  </registration>
</reginfo>
```

8. 200 OK NUT -> P-CSCF

SIP/2.0 200 OK
Via: SIP/2.0/UDP p.a1.under.test.com:10001;branch=z9hG4bK240f34.1;received=3ffe:501:ffff:100::10,
SIP/2.0/UDP s.a1.under.test.com;branch=z9hG4bK332b23.1;received=3ffe:501:ffff:100::30
From: <sip:UEa1_public_1@under.test.com>;tag=151170
To: <sip:UEa1_public_1@under.test.com>;tag=31415
Call-ID: b89rjhnedlrffflslj40a222@under.test.com
CSeq: 1 NOTIFY
Content-Length: 0

[OBSERVABLE RESULTS]

*1: 1 REGISTER from NUT to P-CSCF

See generic_REGISTER

*2: 3 REGISTER for authentication from NUT to P-CSCF



See generic_Auth_REGISTER

*3: 5 SUBSCRIBE from NUT to P-CSCF

See generic_SUBSCRIBE

*4: 8 NOTIFY 200 OK from NUT to P-CSCF

See generic_200-NOTIFY

4.1.2 UE-RG-B-2-AKA - User-initiated reregistration

[NAME]

UE-RG-B-2-AKA - User-initiated reregistration

[TARGET]

IMS User Equipment (NUT)

[PURPOSE]

(1) To verify that the UEa1 properly reregisters an already registered public user without a challenge response when half of the time has expired when the previous registration was for 1200 seconds or less.

(2) To verify that the UEa1 properly protects the REGISTER request using a security association, established as a result of an earlier registration.

[REFERENCE]

TS24.229 5.1.1.4.1

TS24.229 5.1.1.4.3

[REQUIREMENT]

NONE

[PARAMETER(NUT)]

public-user-id : sip:UEa1_public_1@under.test.com

private-user-id : UEa1_private@under.test.com



```

contact_URI           : sip:UEa1_public_1@node.under.test.com
HOMENETWORK Domain   : sip:under.test.com

```

[PARAMETER(TESTER)]

```

P-CSCFa1             : sip:p.a1.under.test.com
S-CSCFa1             : sip:s.a1.under.test.com

```

[ADDRESS]

```

UEa1(NUT)            : 3ffe:501:fff:1000::1000
Router(R1)           : 3ffe:501:fff:1000::1
P-CSCFa1             : 3ffe:501:fff:100::10
I-CSCFa1             : 3ffe:501:fff:100::20
S-CSCFa1             : 3ffe:501:fff:100::30
DNS                   : 3ffe:501:fff:100::40
DHCP                  : 3ffe:501:fff:100::50

```

[TOPOLOGY]

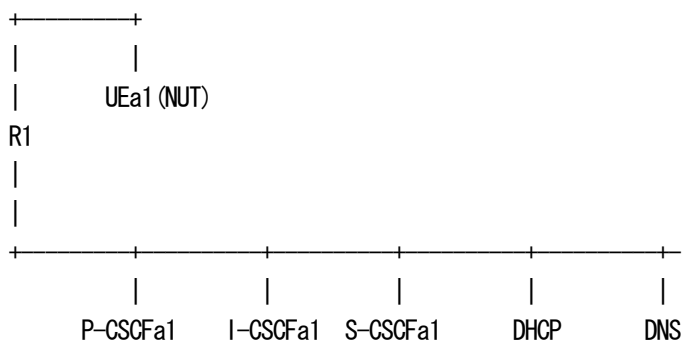

[INITIALIZATION]

Set up IP Address using A or B.

A. Router Advertisement

B. DHCPv6

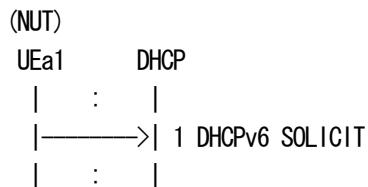



```

|<-----| 2 DHCPv6 ADVERTISE
|   :   |
|----->| 3 DHCPv6 REQUEST
|   :   |
|<-----| 4 DHCPv6 REPLY
|   :   |

```

[PROCEDURE]

Home Network

(NUT)

UEa1	P-CSCFa1	I-CSCFa1	S-CSCFa1
	:		
	----->		1 REGISTER
	:		
	:	----->	REGISTER
	:		
	:	----->	REGISTER
	:		
	:	<-----	401 Unauthorized
	:		
	:	<-----	401 Unauthorized
	:		
	<-----		2 401 Unauthorized
	:		
	----->		3 REGISTER for authentication
	:		
	:	----->	REGISTER for authentication
	:		
	:	----->	REGISTER for authentication
	:		
	:	<-----	200 OK with expires=60
	:		
	:	<-----	200 OK with expires=60
	:		
	<-----		4 200 OK with expires=60
	:		
	----->		5 SUBSCRIBE
	:		
	:	----->	SUBSCRIBE
	:		
	:	<-----	200 OK

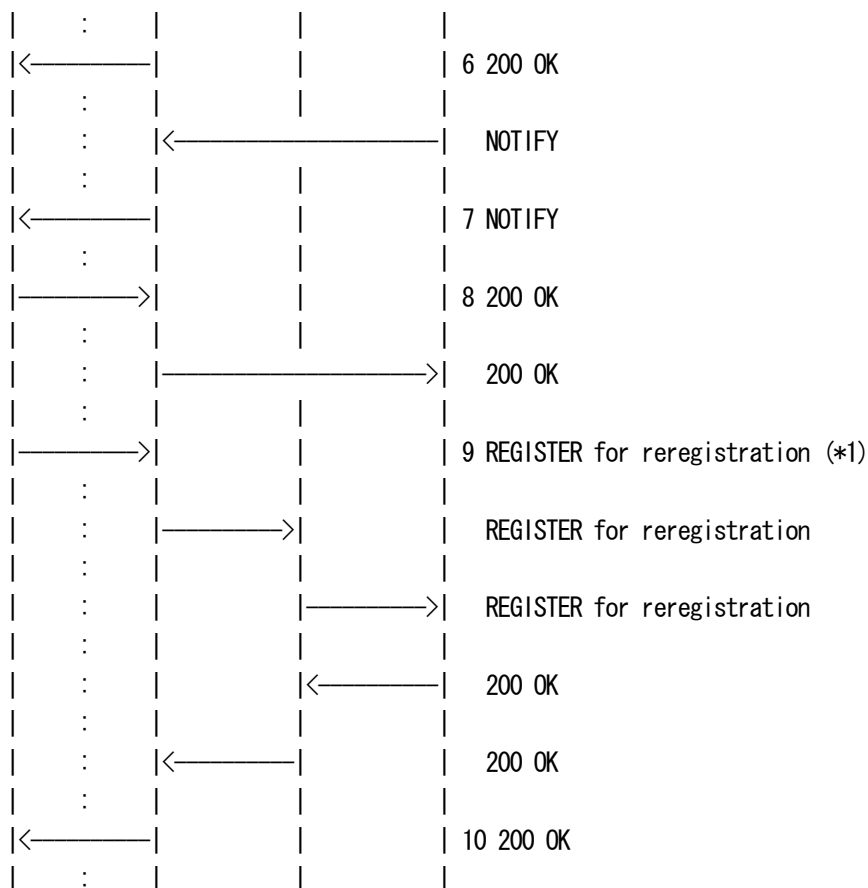

- 1 NUT sends REGISTER
- 2 NUT receives 401 Unauthorized
- 3 NUT sends REGISTER for authentication
- 4 NUT receives 200 OK
- 5 NUT sends SUBSCRIBE
- 6 NUT receives 200 OK
- 7 NUT receives NOTIFY
- 8 NUT sends 200 OK
- 9 NUT sends REGISTER for reregistration
- 10 NUT receives 200 OK

=== Message example ===

As regards the message 1-3, please refer to the message 1-3 in UE-RG-B-1-AKA.

4. 200 OK P-CSCF -> NUT

SIP/2.0 200 OK

Via: SIP/2.0/UDP [3ffe:501:ffff:1000::1000]:1357;branch=z9hG4bKnashds8

From: <sip:UEa1_public_1@under.test.com>;tag=4fa3

To: <sip:UEa1_public_1@under.test.com>;tag=5ef5



Call-ID: apb03a0s09dkjdfglkj49111@under.test.com
Contact: <sip:UEa1_public_1@node.under.test.com:1357>;expires=60
Path: <sip:term@p.a1.under.test.com;lr>
Service-Route: <sip:orig@s.a1.under.test.com;lr>
P-Associated-URI: <sip:UEa1_public_1@under.test.com>
CSeq: 2 REGISTER
Date: Wed, 11 July 2001 08:49:37 GMT
Content-Length: 0

As regards the message 5-8, please refer to the message 5-8 in UE-RG-B-1-AKA.

9. REGISTER NUT -> P-CSCF

REGISTER sip:under.test.com SIP/2.0
Via: SIP/2.0/UDP [3ffe:501:ffff:1000::1000]:1357;branch=z9hG4bKnashds9
Max-Forwards: 70
From: <sip:UEa1_public_1@under.test.com>;tag=4fa4
To: <sip:UEa1_public_1@under.test.com>
Contact: <sip:UEa1_public_1@node.under.test.com:1357>;expires=600000
Call-ID: apb03a0s09dkjdfglkj49111@under.test.com
Authorization: Digest username="UEa1_private@under.test.com", realm="under.test.com",
nonce="11U8vpY3qJhiuZnrke/NaponGSCcLm5iR+WCRkWYoM", uri="sip:under.test.com",
response="6629fae49393a05397450978507c4ef1"
Security-Client: ipsec-3gpp; mode="trans"; alg=hmac-sha-1-96; spi-c=33456789; spi-s=22345678;
port-c=3468; port-s=1357
Security-Verify: ipsec-3gpp; alg=hmac-sha-1-96; spi-c=256; spi-s=257; port-c=10002; port-s=10001
Require: sec-agree
Proxy-Require: sec-agree
CSeq: 3 REGISTER
Supported: path
Content-Length: 0

10. 200 OK P-CSCF -> NUT

SIP/2.0 200 OK
Via: SIP/2.0/UDP [3ffe:501:ffff:1000::1000]:1357;branch=z9hG4bKnashds9
From: <sip:UEa1_public_1@under.test.com>;tag=4fa4
To: <sip:UEa1_public_1@under.test.com>;tag=5ef6
Call-ID: apb03a0s09dkjdfglkj49111@under.test.com
Contact: <sip:UEa1_public_1@node.under.test.com:1357>;expires=600000
Path: <sip:term@p.a1.under.test.com;lr>
Service-Route: <sip:orig@s.a1.under.test.com;lr>



P-Associated-URI: <sip:UEa1_public_1@under.test.com>

CSeq: 3 REGISTER

Date: Wed, 11 July 2001 08:50:08 GMT

Content-Length: 0

[OBSERVABLE RESULTS]

*1: 9 REGISTER for reregistration from NUT to P-CSCF

See generic_re_REGISTER

4.1.3 UE-RG-B-3-AKA - Network-initiated re-authentication

[NAME]

UE-RG-B-3-AKA - Network-initiated re-authentication

[TARGET]

IMS User Equipment (NUT)

[PURPOSE]

- (1) To verify that the UEa1 properly receives a NOTIFY request carrying information related to the reg event package and answers to a network-initiated re-authentication on the dialog.
- (2) To verify that the UEa1 properly performs the authentication procedure when received a 401 (Unauthorized) response to the REGISTER request for reregistration.

[REFERENCE]

TS24.229 5.1.1.4.1

TS24.229 5.1.1.4.2

TS24.229 5.1.1.5A

TS33.203 6.1.4

[REQUIREMENT]

NONE



[PARAMETER(NUT)]

public-user-id : sip:UEa1_public_1@under.test.com
private-user-id : UEa1_private@under.test.com
contact_URI : sip:UEa1_public_1@node.under.test.com
HOMENETWORK Domain : sip:under.test.com

[PARAMETER(TESTER)]

P-CSCFa1 : sip:p.a1.under.test.com
S-CSCFa1 : sip:s.a1.under.test.com

[ADDRESS]

UEa1(NUT) : 3ffe:501:fff:1000::1000
Router(R1) : 3ffe:501:fff:1000::1
P-CSCFa1 : 3ffe:501:fff:100::10
I-CSCFa1 : 3ffe:501:fff:100::20
S-CSCFa1 : 3ffe:501:fff:100::30
DNS : 3ffe:501:fff:100::40
DHCP : 3ffe:501:fff:100::50

[TOPOLOGY]

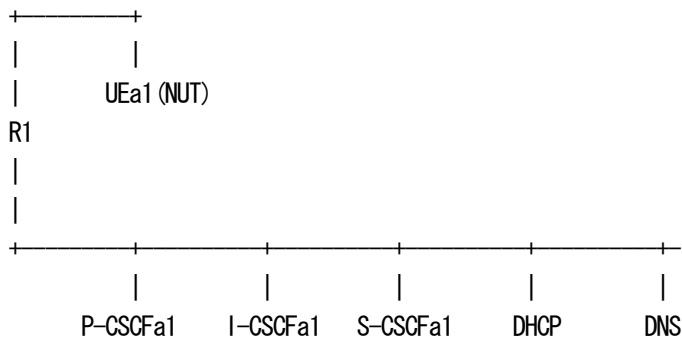

[INITIALIZATION]

Set up IP Address using A or B.

A. Router Advertisement

B. DHCPv6

(NUT)

UEa1 DHCP

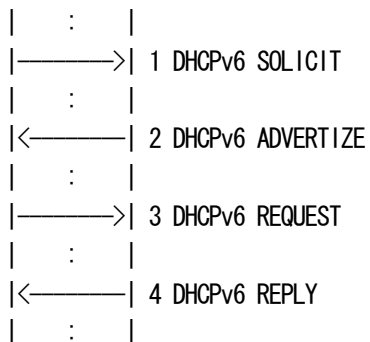

[PROCEDURE]

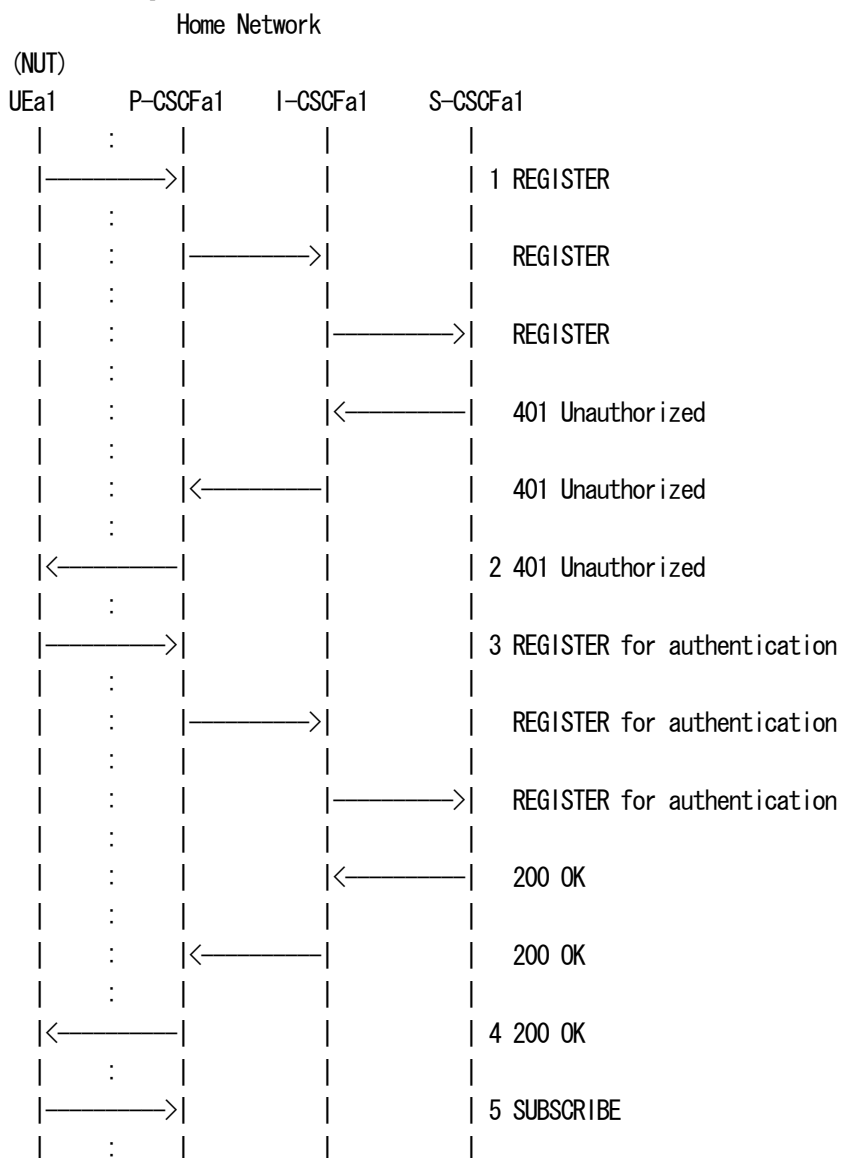

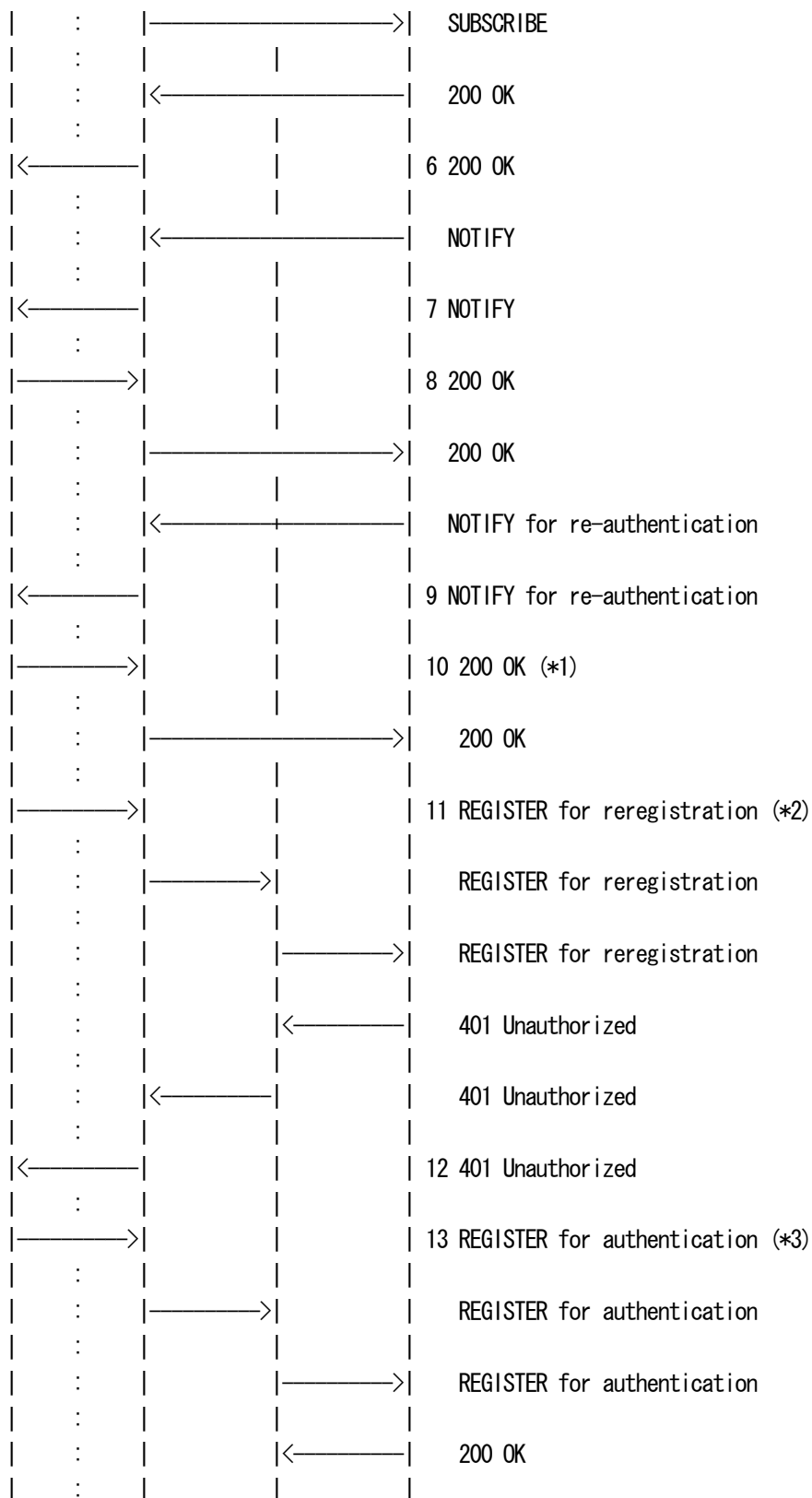



- 1 NUT sends REGISTER
- 2 NUT receives 401 Unauthorized
- 3 NUT sends REGISTER for authentication
- 4 NUT receives 200 OK
- 5 NUT sends SUBSCRIBE
- 6 NUT receives 200 OK
- 7 NUT receives NOTIFY
- 8 NUT sends 200 OK
- 9 NUT receives NOTIFY for re-authentication
- 10 NUT sends 200 OK
- 11 NUT sends REGISTER for reregistration
- 12 NUT receives 401 Unauthorized
- 13 NUT sends REGISTER for authentication
- 14 NUT receives 200 OK
- 15 NUT receives NOTIFY
- 16 NUT sends 200 OK

=== Message example ===

As regards the message 1-8, please refer to the message 1-8 in UE-RG-B-1-AKA.

9. NOTIFY P-CSCF -> NUT

```
NOTIFY sip:UEa1_public_1@node.under.test.com:1357 SIP/2.0
Via: SIP/2.0/UDP p.a1.under.test.com:10001;branch=z9hG4bK240f34.2,
SIP/2.0/UDP s.a1.under.test.com;branch=z9hG4bK332b23.2;received=3ffe:501:ffff:100::30
Max-Forwards: 69
From: <sip:UEa1_public_1@under.test.com>;tag=151170
To: <sip:UEa1_public_1@under.test.com>;tag=31415
Call-ID: b89rjhnedlrfjflsj40a222@under.test.com
CSeq: 2 NOTIFY
Subscription-State: active;expires=600000
Event: reg
Content-Type: application/reginfo+xml
Contact: <sip:s.a1.under.test.com>
Content-Length: (...)
```

```
<?xml version="1.0"?>
<reginfo xmlns="urn:ietf:params:xml:ns:reginfo" version="1" state="full">
  <registration acr="sip:UEa1_public_1@under.test.com" id="a7" state="active">
```



```
<contact id="76" state="active" event="shortened" expires="60">
  <uri>sip:UEa1_public_1@node.under.test.com</uri>
</contact>
</registration>
</reginfo>
```

10. 200 OK NUT -> P-CSCF

SIP/2.0 200 OK

Via: SIP/2.0/UDP p.a1.under.test.com:10001;branch=z9hG4bK240f34.2;received=3ffe:501:ffff:100::10,

SIP/2.0/UDP s.a1.under.test.com;branch=z9hG4bK332b23.2;received=3ffe:501:ffff:100::30

From: <sip:UEa1_public_1@under.test.com>;tag=151170

To: <sip:UEa1_public_1@under.test.com>;tag=31415

Call-ID: b89rjhnedlrfflsj40a222@under.test.com

CSeq: 2 NOTIFY

Content-Length: 0

11. REGISTER NUT -> P-CSCF

REGISTER sip:under.test.com SIP/2.0

Via: SIP/2.0/UDP [3ffe:501:ffff:1000::1000]:1357;branch=z9hG4bKnashds9

Max-Forwards: 70

From: <sip:UEa1_public_1@under.test.com>;tag=4fa4

To: <sip:UEa1_public_1@under.test.com>

Contact: <sip:UEa1_public_1@node.under.test.com:1357>;expires=600000

Call-ID: apb03a0s09dkjdfglkj49111@under.test.com

Authorization: Digest username="UEa1_private@under.test.com", realm="under.test.com",
nonce="11U8vpY3qJhiuZnrke/NaponGSCclm5iR+WCRkWYoM", uri="sip:under.test.com",
response="6629fae49393a05397450978507c4ef1"

Security-Client: ipsec-3gpp; mode="trans"; alg=hmac-sha-1-96; spi-c=33456789; spi-s=22345678;
port-c=3468; port-s=1357

Security-Verify: ipsec-3gpp; alg=hmac-sha-1-96; spi-c=256; spi-s=257; port-c=10002; port-s=10001

Require: sec-agree

Proxy-Require: sec-agree

CSeq: 3 REGISTER

Supported: path

Content-Length: 0

12. 401 Unauthorized P-CSCF -> NUT

SIP/2.0 401 Unauthorized

Via: SIP/2.0/UDP [3ffe:501:ffff:1000::1000]:1357;branch=z9hG4bKnashds9

WWW-Authenticate: Digest realm="under.test.com",



nonce="J2U8vpY3qJhiuZNrke/ObponGSCcLm5iR+WCRkWYoM", algorithm=AKAv1-MD5
From: <sip:UEa1_public_1@under.test.com>;tag=4fa4
To: <sip:UEa1_public_1@under.test.com>;tag=5ef6
Call-ID: apb03a0s09dkjdfglkj49111@under.test.com
CSeq: 3 REGISTER
Security-Server: ipsec-3gpp; alg=hmac-sha-1-96; spi-c=266; spi-s=267; port-c=10004; port-s=10001
Content-Length: 0

13. REGISTER NUT -> P-CSCF

REGISTER sip:under.test.com SIP/2.0
Via: SIP/2.0/UDP [3ffe:501:ffff:1000::1000]:1357;branch=z9hG4bKnashds10
Max-Forwards: 70
From: <sip:UEa1_public_1@under.test.com>;tag=4fa4
To: <sip:UEa1_public_1@under.test.com>
Contact: <sip:UEa1_public_1@node.under.test.com:1357>;expires=600000
Call-ID: apb03a0s09dkjdfglkj49111@under.test.com
Authorization: Digest username="UEa1_private@under.test.com", realm="under.test.com",
algorithm=AKAv1-MD5, nonce="J2U8vpY3qJhiuZNrke/ObponGSCcLm5iR+WCRkWYoM",
uri="sip:under.test.com", response="7729fae49393a05397450978507c4ef2"
Security-Client: ipsec-3gpp; mode="trans"; alg=hmac-sha-1-96; spi-c=33456789; spi-s=22345678;
port-c=3468; port-s=1357
Security-Verify: ipsec-3gpp; alg=hmac-sha-1-96; spi-c=266; spi-s=267; port-c=10004; port-s=10001
Require: sec-agree
Proxy-Require: sec-agree
CSeq: 4 REGISTER
Supported: path
Content-Length: 0

14. 200 OK P-CSCF -> NUT

SIP/2.0 200 OK
Via: SIP/2.0/UDP [3ffe:501:ffff:1000::1000]:1357;branch=z9hG4bKnashds10
From: <sip:UEa1_public_1@under.test.com>;tag=4fa4
To: <sip:UEa1_public_1@under.test.com>;tag=5ef7
Call-ID: apb03a0s09dkjdfglkj49111@under.test.com
CSeq: 4 REGISTER
Contact: <sip:UEa1_public_1@node.under.test.com:1357>;expires=600000
Path: <sip:term@p.a1.under.test.com;lr>
Service-Route: <sip:orig@s.a1.under.test.com;lr>
P-Associated-URI: <sip:UEa1_public_1@under.test.com>
Date: Wed, 11 July 2001 08:49:37 GMT
Content-Length: 0



[OBSERVABLE RESULTS]

*1: 10 NOTIFY 200 OK from NUT to P-CSCF

See generic_200-NOTIFY

*2: 11 REGISTER for reregistration from NUT to P-CSCF

See generic_re_REGISTER

The UE SHALL use the expiry attribute within the <contact> sub-element that the UE registered to adjust the expiration time for that public user identity.

[TS24229-5.1-278]

*3: 13 REGISTER for authentication

See generic_Auth_REGISTER

The protected server port value for the UDP SHALL be included in Via header field.[TS24229-5.1-189]

4.1.4 UE-RG-B-4-AKA - User-initiated deregistration

[NAME]

UE-RG-B-4-AKA - User-initiated deregistration

[TARGET]

IMS User Equipment (NUT)

[PURPOSE]

- (1) To verify that the UEa1 properly deregisters a public user identity that it has previously registered with its contact address and deletes the security associations.
- (2) To verify that the UEa1 properly protects the REGISTER request using a security association established as a result of an earlier registration.
- (3) To verify that the UEa1 properly considers subscription to the reg event package cancelled.



(i.e. as if the UE had sent a SUBSCRIBE request with an Expires header containing a value of zero).

[REFERENCE]

TS24.229 5.1.1.1
TS24.229 5.1.1.6.1
TS24.229 5.1.1.6.2
RFC3261 10.2.2

[REQUIREMENT]

NONE

[PARAMETER(NUT)]

public-user-id : sip:UEa1_public_1@under.test.com
private-user-id : UEa1_private@under.test.com
contact_URI : sip:UEa1_public_1@node.under.test.com
HOMENETWORK Domain : sip.under.test.com

[PARAMETER(TESTER)]

P-CSCF : sip:p.a1.under.test.com
S-CSCFa1 : sip:s.a1.under.test.com

[ADDRESS]

UEa1(NUT) : 3ffe:501:fff:1000::1000
Router(R1) : 3ffe:501:fff:1000::1
P-CSCFa1 : 3ffe:501:fff:100::10
I-CSCFa1 : 3ffe:501:fff:100::20
S-CSCFa1 : 3ffe:501:fff:100::30
DNS : 3ffe:501:fff:100::40
DHCP : 3ffe:501:fff:100::50

[TOPOLOGY]

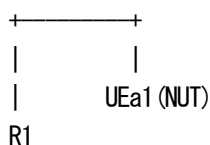

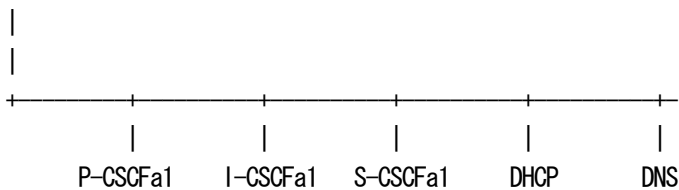

[INITIALIZATION]

Set up IP Address using A or B.

A. Router Advertisement

B. DHCPv6

(NUT)

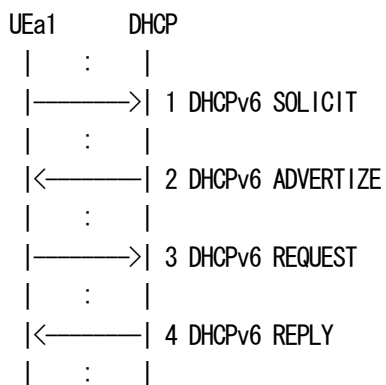

[PROCEDURE]

Home Network

(NUT)

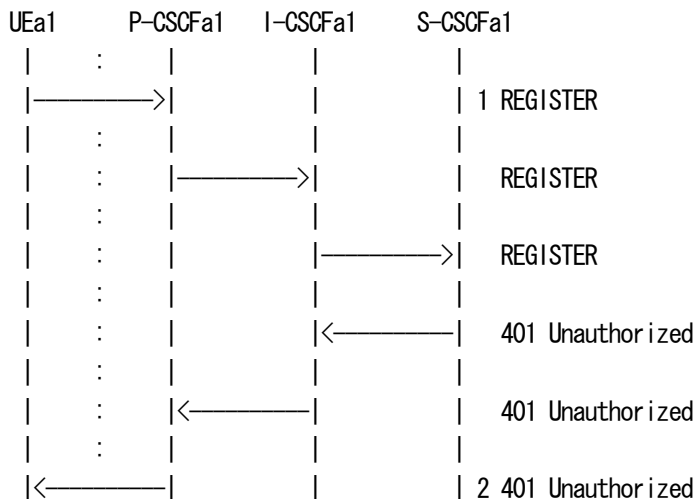

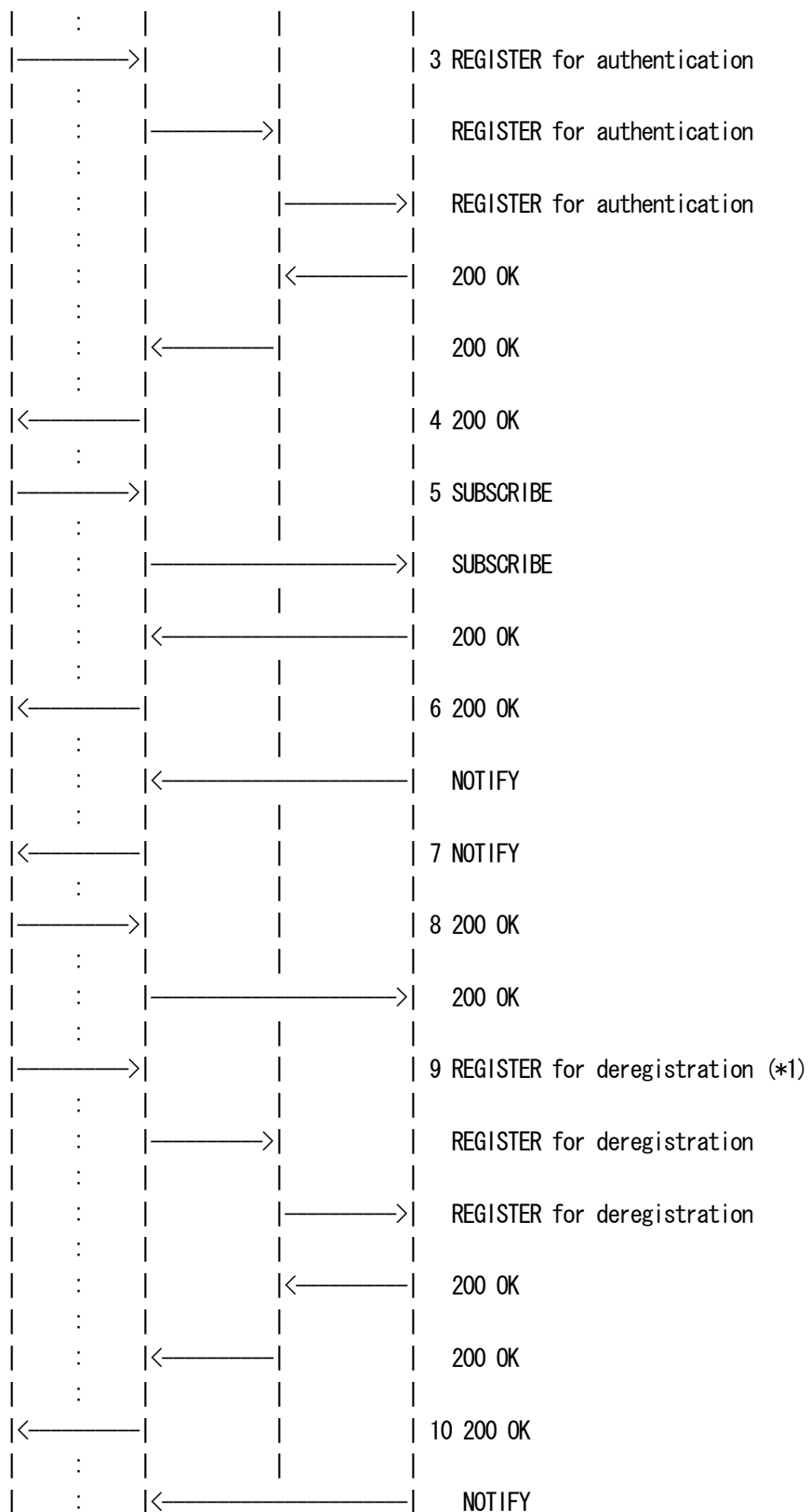

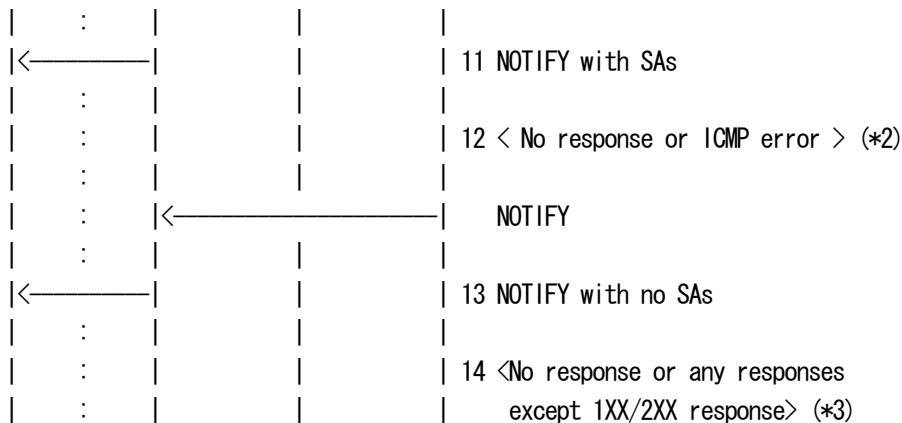

- 1 NUT sends REGISTER
- 2 NUT receives 401 Unauthorized
- 3 NUT sends REGISTER for authentication
- 4 NUT receives 200 OK
- 5 NUT sends SUBSCRIBE
- 6 NUT receives 200 OK
- 7 NUT receives NOTIFY
- 8 NUT sends 200 OK
- 9 NUT sends REGISTER for deregistration
- 10 NUT receives 200 OK
- 11 Tester sends NOTIFY with SAs
- 12 <No response or ICMP error>
- 13 Tester sends NOTIFY with no SAs
- 14 <No response or any response except 1XX/2XX response>

=== Message example ===

As regards the message 1-8, please refer to the message 1-8 in UE-RG-B-1-AKA.

9. REGISTER NUT -> P-CSCF

REGISTER sip:under.test.com SIP/2.0

Via: SIP/2.0/UDP [3ffe:501:ffff:1000::1000]:1357;branch=z9hG4bKnashds9

Max-Forwards: 70

From: <sip:UEa1_public_1@under.test.com>;tag=4fa4

To: <sip:UEa1_public_1@under.test.com>

Contact: <sip:UEa1_public_1@node.under.test.com:1357>;expires=0

Call-ID: apb03a0s09dkjdfglkj49111@under.test.com

Authorization: Digest username="UEa1_private@under.test.com", realm="under.test.com",
 nonce="11U8vpY3qJhiuZNRke/NaponGSCcLm5iR+WCRkWYoM", uri="sip:under.test.com",
 response="6629fae49393a05397450978507c4ef1"

Security-Client: ipsec-3gpp; mode="trans"; alg=hmac-sha-1-96; spi-c=33456789; spi-s=22345678;



port-c=3468; port-s=1357
Security-Verify: ipsec-3gpp; alg=hmac-sha-1-96; spi-c=256; spi-s=257; port-c=10002; port-s=10001
Supported: path
Require: sec-agree
Proxy-Require: sec-agree
CSeq: 3 REGISTER
Content-Length: 0

10. 200 OK P-CSCF -> NUT
SIP/2.0 200 OK
Via: SIP/2.0/UDP [3ffe:501:ffff:1000::1000]:1357;branch=z9hG4bKKnashds9
From: <sip:UEa1_public_1@under.test.com>;tag=4fa4
To: <sip:UEa1_public_1@under.test.com>;tag=5ef6
Contact: <sip:UEa1_public_1@node.under.test.com:1357>;expires=0
Call-ID: apb03a0s09dkjdfglkj49111@under.test.com
CSeq: 3 REGISTER
P-Associated-URI:
Date: Wed, 11 July 2001 08:49:37 GMT
Content-Length: 0

11. NOTIFY P-CSCF -> NUT
NOTIFY sip:UEa1_public_1@node.under.test.com:1357 SIP/2.0
Via: SIP/2.0/UDP p.a1.under.test.com:10001;branch=z9hG4bK240f34.2,
SIP/2.0/UDP s.a1.under.test.com;branch=z9hG4bK332b23.2;received=3ffe:501:ffff:100::30
Max-Forwards: 69
From: <sip:UEa1_public_1@under.test.com>;tag=151170
To: <sip:UEa1_public_1@under.test.com>;tag=31415
Call-ID: b89rjhnedlrfjflsj40a222@under.test.com
CSeq: 2 NOTIFY
Contact: <sip:s.a1.under.test.com>
Subscription-State: terminated;reason=noresource
Event: reg
Content-Type: application/reginfo+xml
Content-Length: (...)

```
<?xml version="1.0"?>
<reginfo xmlns="urn:ietf:params:xml:ns:reginfo" version="1" state="full">
  <registration aor="sip:UEa1_public_1@under.test.com" id="a7" state="terminated">
    <contact id="76" state="terminated" event="unregistered">
      <uri:sip:UEa1_public_1@node.under.test.com</uri>
    </contact>
  </registration>
</reginfo>
```



</registration>
</reginfo>

12. <No response or ICMP error>

13. NOTIFY P-CSCF -> NUT

NOTIFY sip:UEa1_public_1@node.under.test.com:1357 SIP/2.0

Via: SIP/2.0/UDP p.a1.under.test.com:10001;branch=z9hG4bK240f34.3,

SIP/2.0/UDP s.a1.under.test.com;branch=z9hG4bK332b23.3;received=3ffe:501:ffff:100::30

Max-Forwards: 69

From: <sip:UEa1_public_1@under.test.com>;tag=151170

To: <sip:UEa1_public_1@under.test.com>;tag=31415

Call-ID: b89rjhnedlrfflsj40a222@under.test.com

CSeq: 2 NOTIFY

Contact: <sip:s.a1.under.test.com>

Subscription-State: terminated;reason=noresource

Event: reg

Content-Type: application/reginfo+xml

Content-Length: (...)

<?xml version="1.0"?>

<reginfo xmlns="urn:ietf:params:xml:ns:reginfo" version="2" state="full">

 <registration aor="sip:UEa1_public_1@under.test.com" id="a7" state="terminated">

 <contact id="76" state="terminated" event="unregistered">

 <uri>sip:UEa1_public_1@node.under.test.com</uri>

 </contact>

 </registration>

</reginfo>

14. <No response or any responses except 1XX/2XX response>

[OBSERVABLE RESULTS]

*1: 9 REGISTER for deregistration from NUT to P-CSCF

 See generic_de_REGISTER

*2: 12 No response or ICMP error

 - Security behavior:



All registration details relating to the public user identity SHALL be removed when UE received the 200 (OK) response to the REGISTER request.

[TS24229-5.1-310]

The security associations SHALL be deleted by UE if there are no more public user identities registered.[TS24229-5.1-311]

*3: 14 No response or any responses except 200 OK

- Security behavior:

The subscription to the reg event package SHALL be considered cancelled if all public user identities are deregistered and the security association is removed.[TS24229-5.1-312]

4.1.5 UE-RG-B-5-AKA - Network-initiated deregistration with rejected event

[NAME]

UE-RG-B-5-AKA - Network-initiated deregistration with rejected event

[TARGET]

IMS User Equipment (NUT)

[PURPOSE]

(1) To verify that the UEa1 properly receives a NOTIFY request carrying information related to the reg event package, and answers to a network-initiated deregistration event on the dialog.

(2) To verify that the UEa1 properly deletes the security associations towards the P-CSCF after the server transaction pertaining to the received NOTIFY request terminates.

[REFERENCE]

TS24.229 5.1.1.7

[REQUIREMENT]

NONE

[PARAMETER(NUT)]



public-user-id : sip:UEa1_public_1@under.test.com
private-user-id : UEa1_private@under.test.com
contact_URI : sip:UEa1_public_1@node.under.test.com
HOMENETWORK Domain : sip:under.test.com

[PARAMETER(TESTER)]

P-CSCFa1 : sip:p.a1.under.test.com
S-CSCFa1 : sip:s.a1.under.test.com

[ADDRESS]

UEa1(NUT) : 3ffe:501:fff:1000::1000
Router(R1) : 3ffe:501:fff:1000::1
P-CSCFa1 : 3ffe:501:fff:100::10
I-CSCFa1 : 3ffe:501:fff:100::20
S-CSCFa1 : 3ffe:501:fff:100::30
DNS : 3ffe:501:fff:100::40
DHCP : 3ffe:501:fff:100::50

[TOPOLOGY]

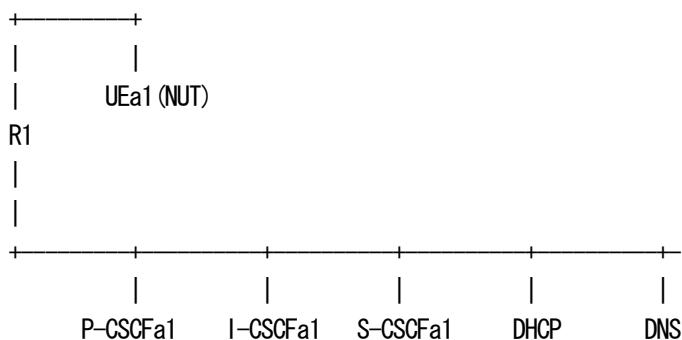

[INITIALIZATION]

Set up IP Address using A or B.

A. Router Advertisement

B. DHCPv6

(NUT)

UEa1 DHCP
| : |

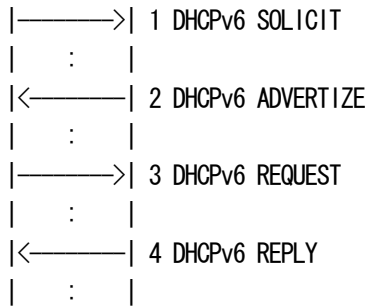

[PROCEDURE]

Home Network

(NUT)

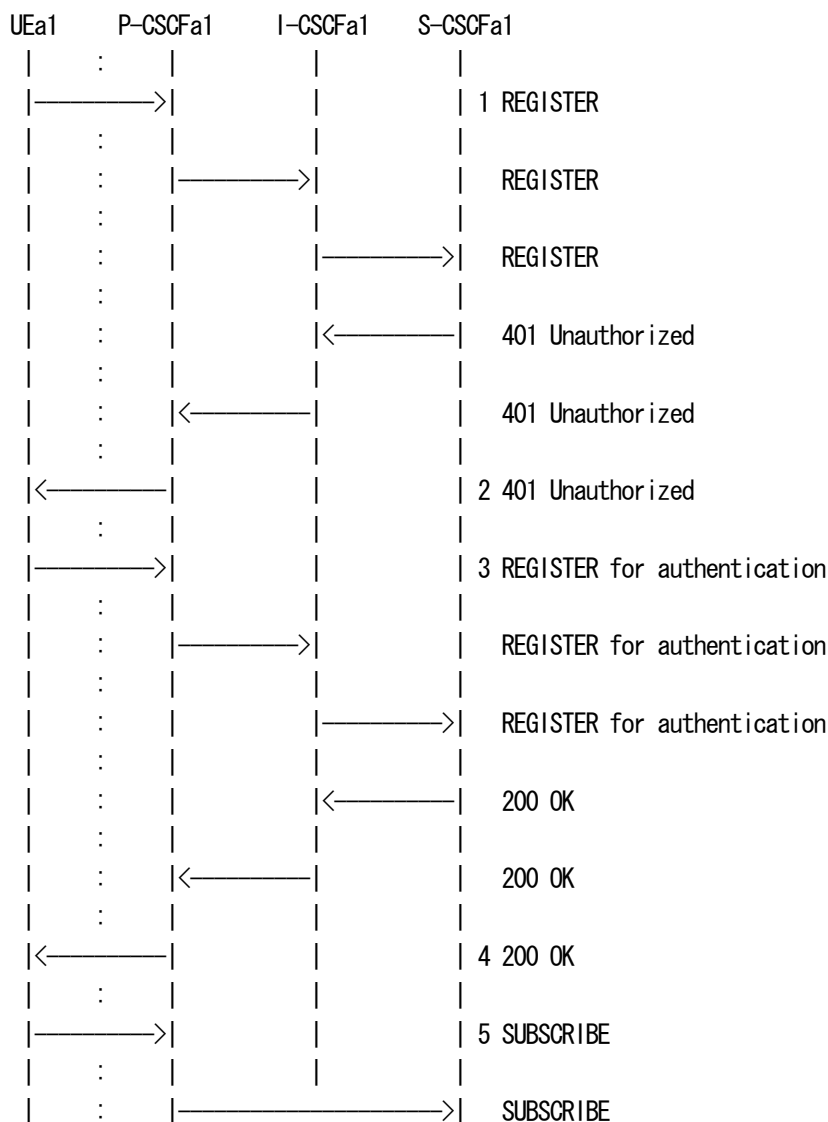

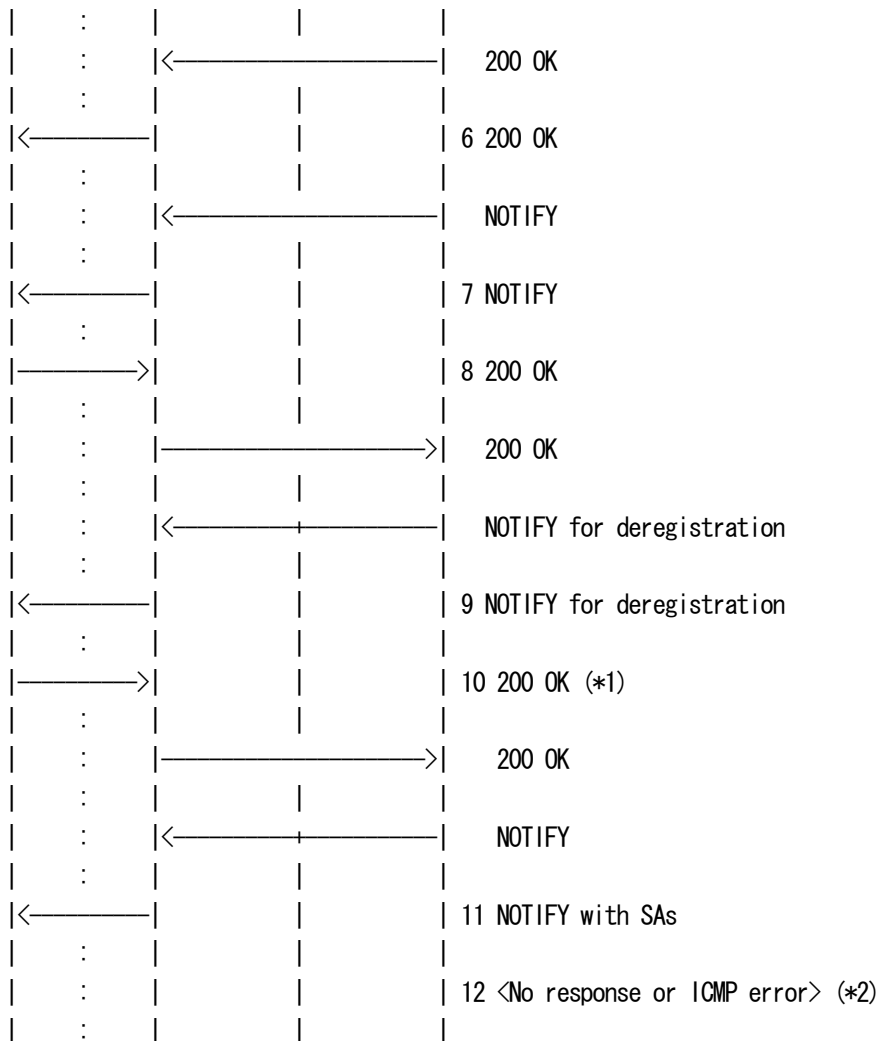

- 1 NUT sends REGISTER
- 2 NUT receives 401 Unauthorized
- 3 NUT sends REGISTER for authentication
- 4 NUT receives 200 OK
- 5 NUT sends SUBSCRIBE
- 6 NUT receives 200 OK
- 7 NUT receives NOTIFY
- 8 NUT sends 200 OK
- 9 NUT receives NOTIFY for deregistration
- 10 NUT sends 200 OK
- 11 Tester sends NOTIFY with SAs
- 12 <No response or ICMP error>

=== Message example ===

As regards the message 1-8, please refer to the message 1-8 in UE-RG-B-1-AKA.



9. NOTIFY P-CSCF -> NUT

NOTIFY sip:UEa1_public_1@node.under.test.com:1357 SIP/2.0
Via: SIP/2.0/UDP p.a1.under.test.com:10001;branch=z9hG4bK240f34.2,
SIP/2.0/UDP s.a1.under.test.com;branch=z9hG4bK332b23.2;received=3ffe:501:ffff:100::30
Max-Forwards: 69
From: <sip:UEa1_public_1@under.test.com>;tag=151170
To: <sip:UEa1_public_1@under.test.com>;tag=31415
Call-ID: b89rjhnedlrffjlsj40a222@under.test.com
CSeq: 2 NOTIFY
Contact: <sip:s.a1.under.test.com>
Subscription-State: terminated; reason=rejected
Event: reg
Content-Type: application/reginfo+xml
Content-Length: (...)

```
<?xml version="1.0"?>
<reginfo xmlns="urn:ietf:params:xml:ns:reginfo" version="1" state="full">
  <registration aor="sip:UEa1_public_1@under.test.com" id="a7" state="terminated">

    <contact id="76" state="terminated" event="rejected">
      <uri>sip:UEa1_public_1@node.under.test.com</uri>
    </contact>
  </registration>
</reginfo>
```

10. 200 OK NUT -> P-CSCF

SIP/2.0 200 OK
Via: SIP/2.0/UDP p.a1.under.test.com:10001;branch=z9hG4bK240f34.2;received=3ffe:501:ffff:100::10,
SIP/2.0/UDP s.a1.under.test.com;branch=z9hG4bK332b23.2;received=3ffe:501:ffff:100::30
From: <sip:UEa1_public_1@under.test.com>;tag=151170
To: <sip:UEa1_public_1@under.test.com>;tag=31415
Call-ID: b89rjhnedlrffjlsj40a222@under.test.com
CSeq: 2 NOTIFY
Content-Length: 0

11. NOTIFY P-CSCF -> NUT

NOTIFY sip:UEa1_public_1@node.under.test.com:1357 SIP/2.0
Via: SIP/2.0/UDP p.a1.under.test.com:10001;branch=z9hG4bK240f34.3,
SIP/2.0/UDP s.a1.under.test.com;branch=z9hG4bK332b23.3;received=3ffe:501:ffff:100::30
Max-Forwards: 69



From: <sip:UEa1_public_1@under.test.com>;tag=151170

To: <sip:UEa1_public_1@under.test.com>;tag=31415

Call-ID: b89rjhnedlrfjflslj40a222@under.test.com

CSeq: 3 NOTIFY

Contact: <sip:s.a1.under.test.com>

Subscription-State: terminated; reason=rejected

Event: reg

Content-Type: application/reginfo+xml

Content-Length: (...)

```
<?xml version="1.0"?>
```

```
<reginfo xmlns="urn:ietf:params:xml:ns:reginfo" version="2" state="full">
```

```
  <registration aor="sip:UEa1_public_1@under.test.com" id="a7" state="terminated">
```

```
    <contact id="76" state="terminated" event="rejected">
```

```
      <uri>sip:UEa1_public_1@node.under.test.com</uri>
```

```
    </contact>
```

```
  </registration>
```

```
</reginfo>
```

12. <No response or ICMP error>

[OBSERVABLE RESULTS]

*1: 10 NOTIFY 200 OK from NUT to P-CSCF

See generic_200-NOTIFY

*2: 12 No response or ICMP error

All dialogs related to those public user identities SHALL be released when the event attribute is set to "rejected".[TS24229-5.1-343]

- Security Behavior:

The UE SHALL delete the security associations towards the P-CSCF if all <registration> element(s) have their state attribute set to "terminated".

[TS24229-5.1-344]

The UE SHALL delete the security associations towards the P-CSCF if each <registration> element that was registered by this UE has either the state attribute set to "terminated", or the state attribute set to "active" and the state attribute within the <contact> element belonging to this UE set to "terminated".[TS24229-5.1-345]



The security associations towards the P-CSCF SHALL be deleted after the server transaction pertaining to the received NOTIFY request terminates.

[TS24229-5.1.1-346]

4.1.6 UE-RG-B-6-AKA - Network-initiated deregistration with deactivated event

[NAME]

UE-RG-B-6-AKA - Network-initiated deregistration with deactivated event

[TARGET]

IMS User Equipment (NUT)

[PURPOSE]

- (1) To verify that the UEa1 properly receives a NOTIFY request carrying information related to the reg event package and answers to a network-initiated deregistration event on the dialog.
- (2) To verify that the UEa1 properly delete the security associations towards the P-CSCF after the server transaction pertaining to the received NOTIFY request terminates.
- (3) To verify that the UEa1 properly starts the initial registration procedure in case of a "deactivated" event attribute.

[REFERENCE]

TS24.229 5.1.1.2.1

TS24.229 5.1.1.2.2

TS24.229 5.1.1.3

TS24.229 5.1.1.7

[REQUIREMENT]

NONE

[PARAMETER(NUT)]

public-user-id : sip:UEa1_public_1@under.test.com

private-user-id : UEa1_private@under.test.com



```

contact_URI          : sip:UEa1_public_1@node.under.test.com
HOMENETWORK Domain  : sip:under.test.com

```

[PARAMETER(TESTER)]

```

P-CSCFa1           : sip:p.a1.under.test.com
S-CSCFa1           : sip:s.a1.under.test.com

```

[ADDRESS]

```

UEa1(NUT)          : 3ffe:501:fff:1000::1000
Router(R1)         : 3ffe:501:fff:1000::1
P-CSCFa1           : 3ffe:501:fff:100::10
I-CSCFa1           : 3ffe:501:fff:100::20
S-CSCFa1           : 3ffe:501:fff:100::30
DNS                 : 3ffe:501:fff:100::40
DHCP                : 3ffe:501:fff:100::50

```

[TOPOLOGY]

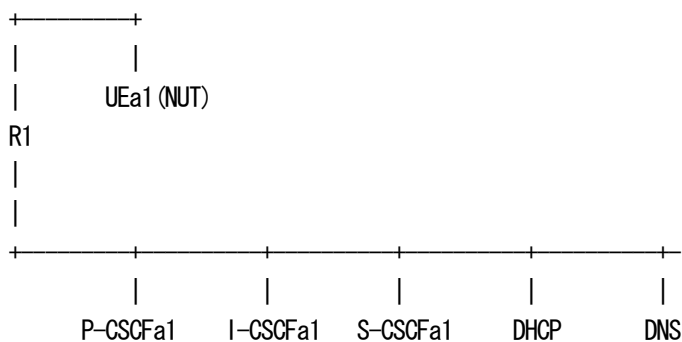

[INITIALIZATION]

Set up IP Address using A or B.

A. Router Advertisement

B. DHCPv6

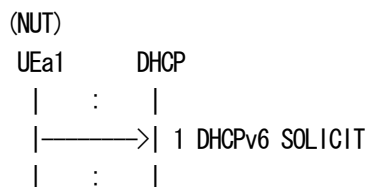

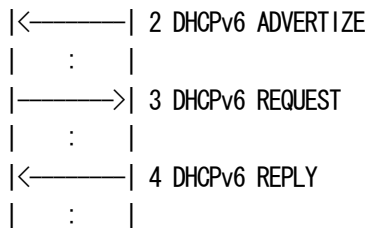

[PROCEDURE]

Home Network

(NUT)

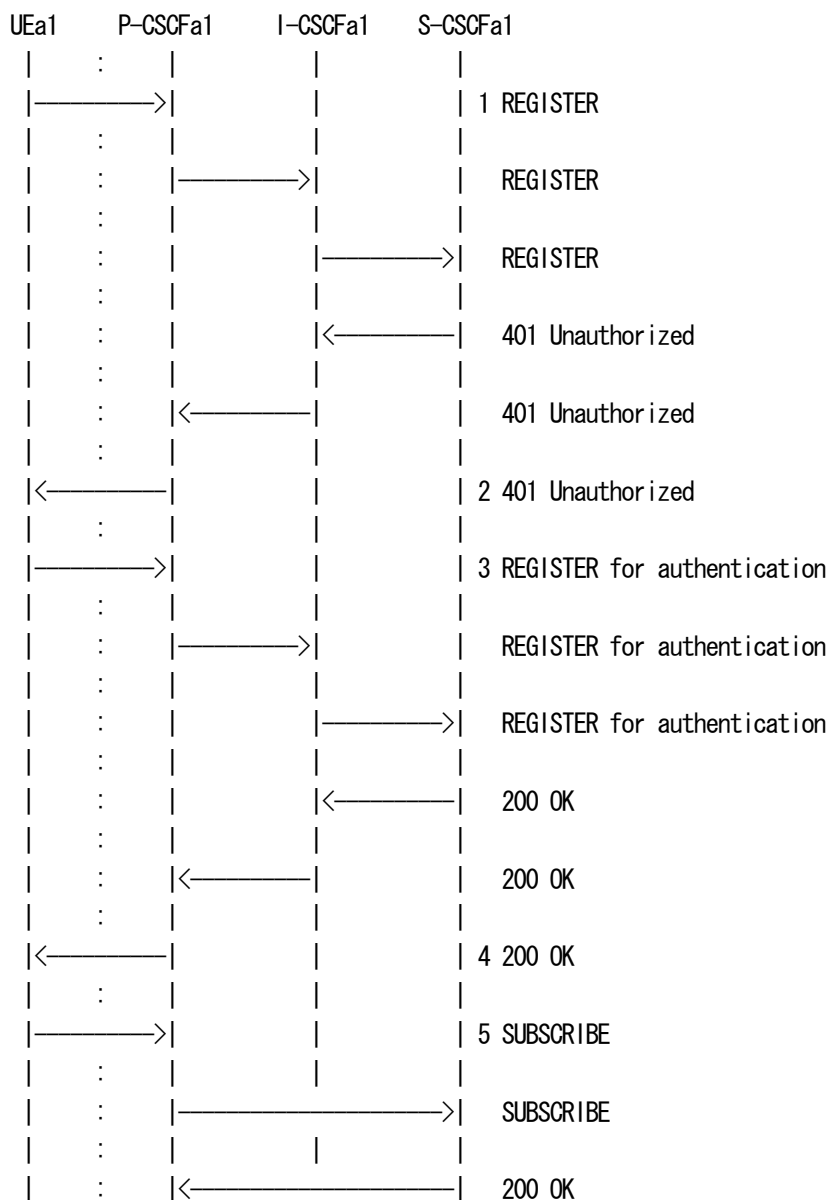

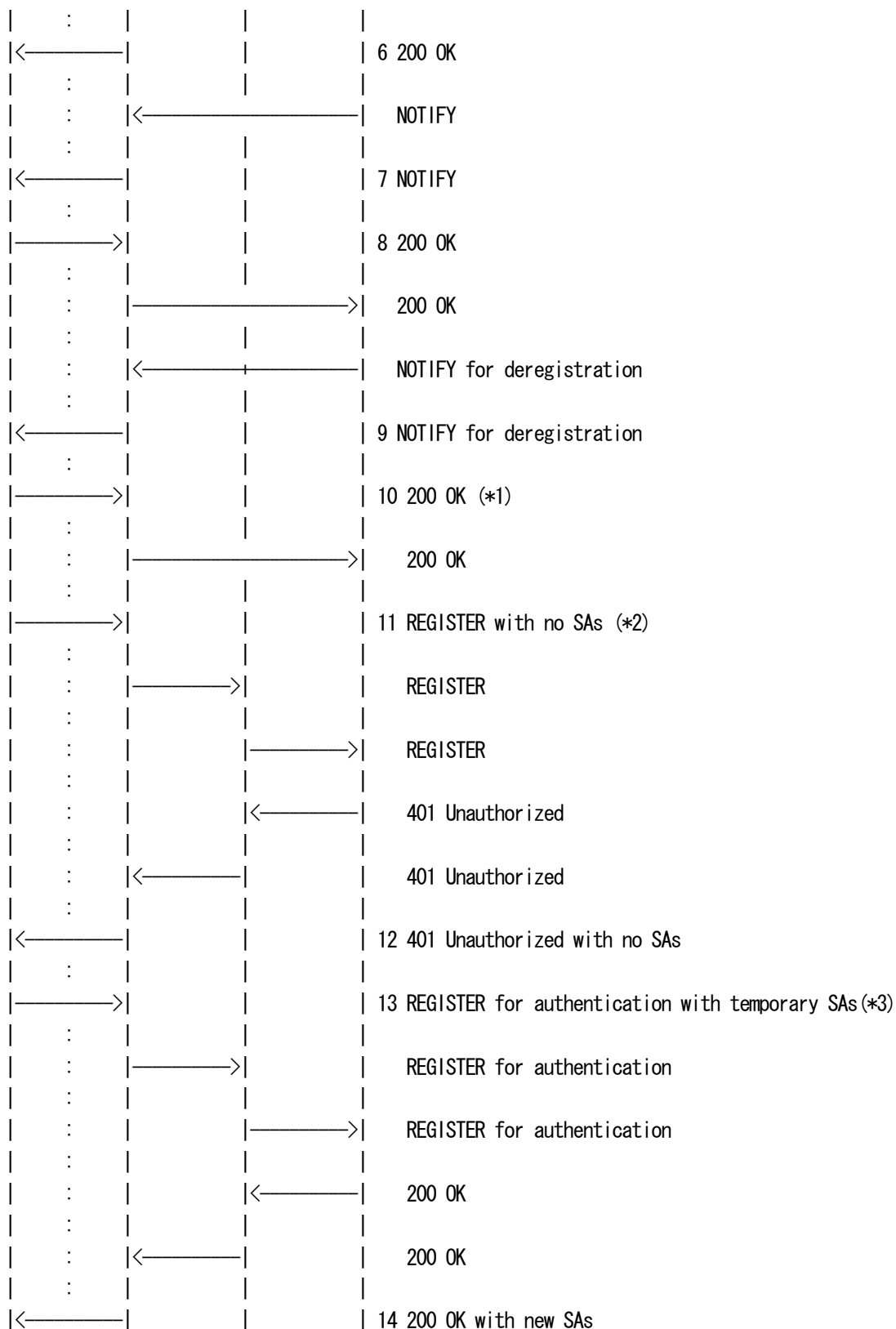

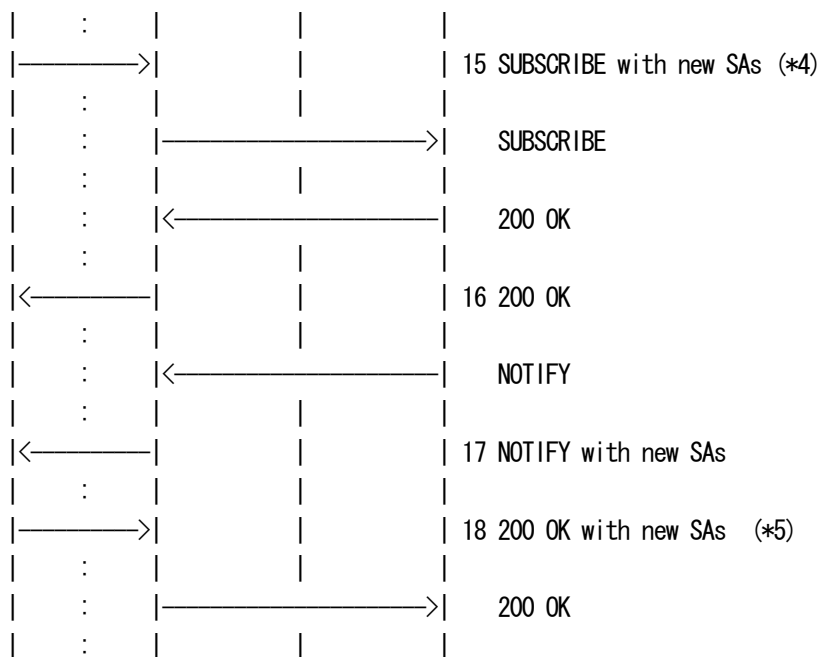

- 1 NUT sends REGISTER
- 2 NUT receives 401 Unauthorized
- 3 NUT sends REGISTER for authentication
- 4 NUT receives 200 OK
- 5 NUT sends SUBSCRIBE
- 6 NUT receives 200 OK
- 7 NUT receives NOTIFY
- 8 NUT sends 200 OK
- 9 NUT receives NOTIFY
- 10 NUT sends 200 OK
- 11 NUT sends REGISTER with no SAs
- 12 NUT receives 401 Unauthorized with no SAs
- 13 NUT sends REGISTER for authentication with temporary SAs
- 14 NUT receives 200 OK with new SAs
- 15 NUT sends SUBSCRIBE with new SAs
- 16 NUT receives 200 OK with new SAs
- 17 NUT receives NOTIFY with new SAs
- 18 NUT sends 200 OK with new SAs

=== Message example ===

As regards the message 1-8, please refer to the message 1-8 in UE-RG-B-1-AKA.

9. NOTIFY P-CSCF -> NUT

NOTIFY sip:UEa1_public_1@node.under.test.com:1357 SIP/2.0



Via: SIP/2.0/UDP p.a1.under.test.com:10001;branch=z9hG4bK240f34.2,
SIP/2.0/UDP s.a1.under.test.com;branch=z9hG4bK332b23.2;received=3ffe:501:ffff:100::30
Max-Forwards: 69
From: <sip:UEa1_public_1@under.test.com>;tag=151170
To: <sip:UEa1_public_1@under.test.com>;tag=31415
Call-ID: b89rjhnedlrfjlsj40a222@under.test.com
CSeq: 2 NOTIFY
Contact: <sip:s.a1.under.test.com>
Subscription-State: terminated;reason=deactivated
Event: reg
Content-Type: application/reginfo+xml
Content-Length: (...)

```
<?xml version="1.0"?>
<reginfo xmlns="urn:ietf:params:xml:ns:reginfo" version="1" state="full">
  <registration aor="sip:UEa1_public_1@under.test.com" id="a7" state="terminated">
    <contact id="76" state="terminated" event="deactivated">
      <uri>sip:UEa1_public_1@node.under.test.com</uri>
    </contact>
  </registration>
</reginfo>
```

10. 200 OK NUT -> P-CSCF

SIP/2.0 200 OK

Via: SIP/2.0/UDP p.a1.under.test.com:10001;branch=z9hG4bK240f34.2;received=3ffe:501:ffff:100::10,
SIP/2.0/UDP s.a1.under.test.com;branch=z9hG4bK332b23.2;received=3ffe:501:ffff:100::30
From: <sip:UEa1_public_1@under.test.com>;tag=151170
To: <sip:UEa1_public_1@under.test.com>;tag=31415
Call-ID: b89rjhnedlrfjlsj40a222@under.test.com
CSeq: 2 NOTIFY
Content-Length: 0

11. REGISTER NUT -> P-CSCF

REGISTER sip:under.test.com SIP/2.0

Via: SIP/2.0/UDP [3ffe:501:ffff:1000::1000]:5060;branch=z9hG4bKnashdt7
Max-Forwards: 70
From: <sip:UEa1_public_1@under.test.com>;tag=5fa3
To: <sip:UEa1_public_1@under.test.com>
Contact: <sip:UEa1_public_1@node.under.test.com>;expires=600000
Call-ID: bpb03a0s09dkjdfglkj49111@under.test.com
Authorization: Digest username="UEa1_private@under.test.com", realm="under.test.com", nonce="",



uri="sip:under.test.com", response=""
Security-Client: ipsec-3gpp; mode="trans"; alg=hmac-sha-1-96; spi-c=33456789; spi-s=22345678;
port-c=3468; port-s=1357
Require: sec-agree
Proxy-Require: sec-agree
CSeq: 1 REGISTER
Supported: path
Content-Length: 0

12. 401 Unauthorized P-CSCF -> NUT

SIP/2.0 401 Unauthorized
Via: SIP/2.0/UDP [3ffe:501:ffff:1000::1000]:5060;branch=z9hG4bKnashdt7
WWW-Authenticate: Digest realm="under.test.com",
nonce="J2U8vpY3qJhiuZnrke/ObponGSCcLm5iR+WCRkWYoM", algorithm=AKAv1-MD5
From: <sip:UEa1_public_1@under.test.com>;tag=5fa3
To: <sip:UEa1_public_1@under.test.com>;tag=6ef4
Call-ID: bpb03a0s09dkjdfglkj49111@under.test.com
Security-Server: ipsec-3gpp; alg=hmac-sha-1-96; spi-c=266; spi-s=267; port-c=10004; port-s=10001
CSeq: 1 REGISTER
Content-Length: 0

13. REGISTER NUT -> P-CSCF

REGISTER sip:under.test.com SIP/2.0
Via: SIP/2.0/UDP [3ffe:501:ffff:1000::1000]:1357;branch=z9hG4bKnashdt8
Max-Forwards: 70
From: <sip:UEa1_public_1@under.test.com>;tag=5fa3
To: <sip:UEa1_public_1@under.test.com>
Contact: <sip:UEa1_public_1@node.under.test.com:1357>;expires=600000
Call-ID: bpb03a0s09dkjdfglkj49111@under.test.com
Authorization: Digest username="UEa1_private@under.test.com", realm="under.test.com",
algorithm=AKAv1-MD5, nonce="J2U8vpY3qJhiuZnrke/ObponGSCcLm5iR+WCRkWYoM",
uri="sip:under.test.com", response="7729fae49393a05397450978507c4ef2"
Security-Client: ipsec-3gpp; mode="trans"; alg=hmac-sha-1-96; spi-c=33456789; spi-s=22345678;
port-c=3468; port-s=1357
Security-Verify: ipsec-3gpp; alg=hmac-sha-1-96; spi-c=266; spi-s=267; port-c=10004; port-s=10001
Require: sec-agree
Proxy-Require: sec-agree
CSeq: 2 REGISTER
Supported: path
Content-Length: 0



14. 200 OK P-CSCF -> NUT
SIP/2.0 200 OK
Via: SIP/2.0/UDP [3ffe:501:ffff:1000::1000]:1357;branch=z9hG4bKnashdt8
From: <sip:UEa1_public_1@under.test.com>;tag=5fa3
To: <sip:UEa1_public_1@under.test.com>;tag=6ef5
Call-ID: bpb03a0s09dkjdfglkj49111@under.test.com
Contact: <sip:UEa1_public_1@node.under.test.com:1357>;expires=600000
Path: <sip:term@p.a1.under.test.com;lr>
Service-Route: <sip:orig@s.a1.under.test.com;lr>
CSeq: 2 REGISTER
P-Associated-URI: <sip:UEa1_public_1@under.test.com>
Date: Wed, 11 July 2001 08:49:37 GMT
Content-Length: 0

15. SUBSCRIBE NUT -> P-CSCF
SUBSCRIBE sip:UEa1_public_1@under.test.com SIP/2.0
Via: SIP/2.0/UDP [3ffe:501:ffff:1000::1000]:1357;branch=z9hG4bKnashdsb1
Max-Forwards: 70
Route: <sip:p.a1.under.test.com:10001;lr>, <sip:orig@s.a1.under.test.com;lr>
From: <sip:UEa1_public_1@under.test.com>;tag=41415
To: <sip:UEa1_public_1@under.test.com>
Require: sec-agree
Proxy-Require: sec-agree
Call-ID: c89rjhnedlrfjflsj40a222@under.test.com
CSeq: 1 SUBSCRIBE
Allow-Events: reg
Event: reg
Security-Verify: ipsec-3gpp; alg=hmac-sha-1-96; spi-c=266; spi-s=267; port-c=10004; port-s=10001
Expires: 600000
Contact: <sip:UEa1_public_1@node.under.test.com:1357>
Content-Length: 0

16. 200 OK P-CSCF -> NUT
SIP/2.0 200 OK
Via: SIP/2.0/UDP [3ffe:501:ffff:1000::1000]:1357;branch=z9hG4bKnashdsb1
Record-Route: <sip:p.a1.under.test.com:10001;lr>
From: <sip:UEa1_public_1@under.test.com>;tag=41415
To: <sip:UEa1_public_1@under.test.com>;tag=251170
Call-ID: c89rjhnedlrfjflsj40a222@under.test.com
CSeq: 1 SUBSCRIBE



Allow-Events: reg
Expires: 600000
Contact: <sip:s.a1.under.test.com>
Content-Length: 0

17. NOTIFY P-CSCF -> NUT

NOTIFY sip:UEa1_public_1@node.under.test.com:1357 SIP/2.0
Via: SIP/2.0/UDP p.a1.under.test.com:10001;branch=z9hG4bK240f82.1,
SIP/2.0/UDP s.a1.under.test.com;branch=z9hG4bK332b56.1;received=3ffe:501:ffff:100::30
Max-Forwards: 69
From: <sip:UEa1_public_1@under.test.com>;tag=251170
To: <sip:UEa1_public_1@under.test.com>;tag=41415
Call-ID: c89rjhnedlrfjflsj40a222@under.test.com
CSeq: 1 NOTIFY
Contact: <sip:s.a1.under.test.com>
Subscription-State: active;expires=600000
Event: reg
Content-Type: application/reginfo+xml
Content-Length: (...)

```
<?xml version="1.0"?>
<reginfo xmlns="urn:ietf:params:xml:ns:reginfo" version="0" state="full">
  <registration aor="sip:UEa1_public_1@under.test.com" id="a7" state="active">
    <contact id="76" state="active" event="registered">
      <uri>sip:UEa1_public_1@node.under.test.com</uri>
    </contact>
  </registration>
</reginfo>
```

18. 200 OK NUT -> P-CSCF

SIP/2.0 200 OK
Via: SIP/2.0/UDP p.a1.under.test.com:10001;branch=z9hG4bK240f82.1;received=3ffe:501:ffff:100::10,
SIP/2.0/UDP s.a1.under.test.com;branch=z9hG4bK332b56.1;received=3ffe:501:ffff:100::30
From: <sip:UEa1_public_1@under.test.com>;tag=251170
To: <sip:UEa1_public_1@under.test.com>;tag=41415
Call-ID: c89rjhnedlrfjflsj40a222@under.test.com
CSeq: 1 NOTIFY
Content-Length: 0

[OBSERVABLE RESULTS]



*1: 10 NOTIFY 200 OK from NUT to P-CSCF

See generic_200-NOTIFY

*2: 11 REGISTER with no SAs from NUT to P-CSCF

See generic_REGISTER

- Security behavior:

The UE SHALL delete the security associations towards the P-CSCF if all <registration> element(s) have their state attribute set to "terminated".

[TS24229-5.1-344]

The UE SHALL delete the security associations towards the P-CSCF if each <registration> element that was registered by this UE has either the state attribute set to "terminated", or the state attribute set to "active" and the state attribute within the <contact> element belonging to this UE set to "terminated".[TS24229-5.1-345]

*3: 13 REGISTER with temporary SAs from NUT to P-CSCF

See generic_Auth_REGISTER

*4: 15 SUBSCRIBE with new SAs from NUT to P-CSCF

See generic_SUBSCRIBE

The subscriber SHOULD retry immediately with a new subscription when the reason code indicates "deactivated".[RFC3265-3.2-22]

*5: 18 NOTIFY 200 OK with new SAs from NUT to P-CSCF

See generic_200-NOTIFY

4.1.7 UE-RG-B-7-AKA - Reception of 423 response to initial registration

[NAME]

UE-RG-B-7-AKA - Reception of 423 response to initial registration

[TARGET]

IMS User Equipment (NUT)



[PURPOSE]

To verify that UEa1 sends another REGISTER request populating the Expires header or the expires parameter with an expiration timer of at least the value received in the Min-Expires header of the 423 (Interval Too Brief) response.

[REFERENCE]

TS24.229 5.1.1.2.1

[REQUIREMENT]

NONE

[PARAMETER(NUT)]

public-user-id : sip:UEa1_public_1@under.test.com
private-user-id : UEa1_private@under.test.com
contact_URI : sip:UEa1_public_1@node.under.test.com
HOMENETWORK Domain : sip.under.test.com

[PARAMETER(TESTER)]

P-CSCFa1 : sip:p.a1.under.test.com
S-CSCFa1 : sip:s.a1.under.test.com

[ADDRESS]

UEa1(NUT) : 3ffe:501:fff:1000::1000
Router(R1) : 3ffe:501:fff:1000::1
P-CSCFa1 : 3ffe:501:fff:100::10
I-CSCFa1 : 3ffe:501:fff:100::20
S-CSCFa1 : 3ffe:501:fff:100::30
DNS : 3ffe:501:fff:100::40
DHCP : 3ffe:501:fff:100::50

[TOPOLOGY]

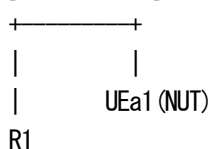

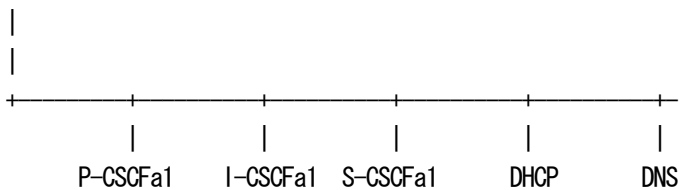

[INITIALIZATION]

Set up IP Address using A or B.

A. Router Advertisement

B. DHCPv6

(NUT)

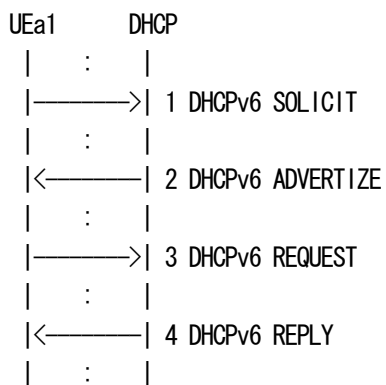

[PROCEDURE]

Home Network

(NUT)

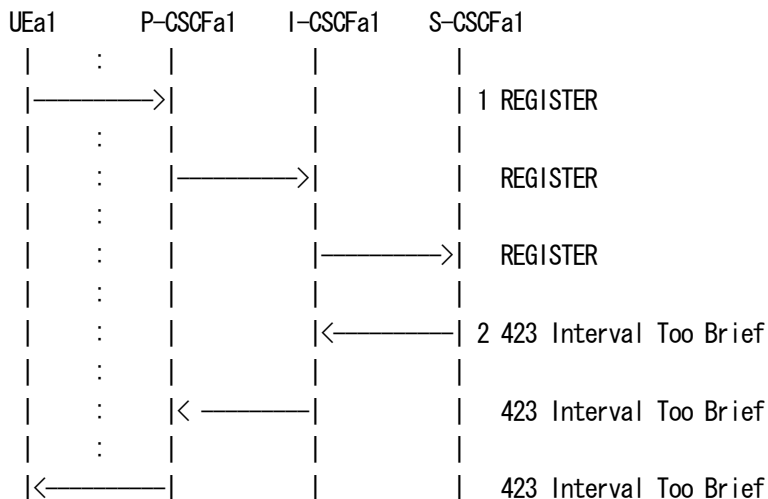

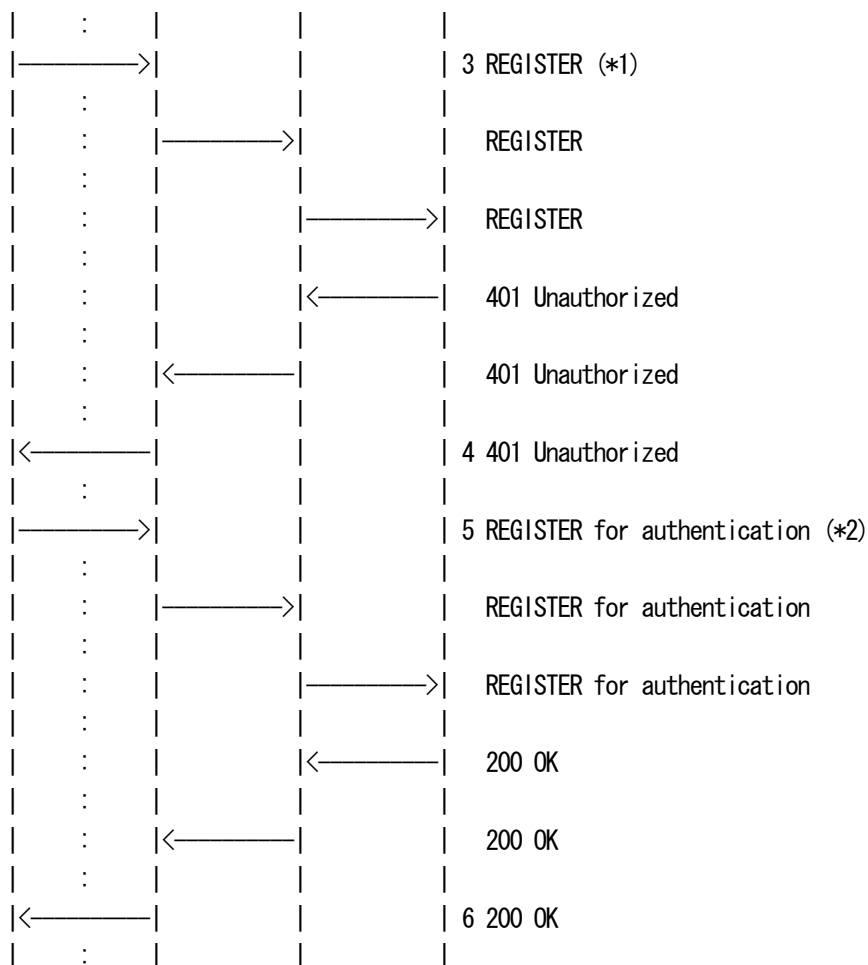

- 1 NUT sends REGISTER
- 2 NUT receives 423 Interval Too Brief
- 3 NUT sends REGISTER
- 4 NUT receives 401 Unauthorized
- 5 NUT sends REGISTER for authentication
- 6 NUT receives 200 OK

=== Message example ===

As regards the message 1, please refer to the message 1 in UE-RG-B-1-AKA.

2. 423 Interval Too Brief P-CSCF -> NUT
 SIP/2.0 423 Interval Too Brief
 Via: SIP/2.0/UDP [3ffe:501:ffff:1000::1000]:5060;branch=z9hG4bKnashds7
 From: <sjp:UEa1_public_1@under.test.com>;tag=4fa3
 To: <sjp:UEa1_public_1@under.test.com>;tag=5ef4
 Call-ID: apb03a0s09dkjdfglkj49111@under.test.com



CSeq: 1 REGISTER

Min-Expires: 600000

Content-Length: 0

3. REGISTER NUT -> P-CSCF

REGISTER sip:under.test.com SIP/2.0

Via: SIP/2.0/UDP [3ffe:501:ffff:1000::1000]:5060;branch=z9hG4bKnashds8

Max-Forwards: 70

From: <sip:UEa1_public_1@under.test.com>;tag=4fa4

To: <sip:UEa1_public_1@under.test.com>

Contact: <sip:UEa1_public_1@node.under.test.com>;expires=600000

Call-ID: apb03a0s09dkjdfglkj49111@under.test.com

Authorization: Digest username="UEa1_private@under.test.com", realm="under.test.com", nonce="", uri="sip:under.test.com", response=""

Security-Client: ipsec-3gpp; mode="trans"; alg=hmac-sha-1-96; spi-c=23456789; spi-s=12345678; port-c=2468; port-s=1357

Require: sec-agree

Proxy-Require: sec-agree

CSeq: 2 REGISTER

Supported: path

Content-Length: 0

4. 401 Unauthorized P-CSCF -> NUT

SIP/2.0 401 Unauthorized

Via: SIP/2.0/UDP [3ffe:501:ffff:1000::1000]:5060;branch=z9hG4bKnashds8

WWW-Authenticate: Digest realm="under.test.com",

nonce="11U8vpY3qJhiuZNRke/NaponGSCcLm5iR+WCRkWYoM", algorithm=AKAv1-MD5

From: <sip:UEa1_public_1@under.test.com>;tag=4fa4

To: <sip:UEa1_public_1@under.test.com>;tag=5ef5

Call-ID: apb03a0s09dkjdfglkj49111@under.test.com

Security-Server: ipsec-3gpp; alg=hmac-sha-1-96; spi-c=256; spi-s=257; port-c=10002; port-s=10001

CSeq: 2 REGISTER

Content-Length: 0

5. REGISTER NUT -> P-CSCF

REGISTER sip:under.test.com SIP/2.0

Via: SIP/2.0/UDP [3ffe:501:ffff:1000::1000]:1357;branch=z9hG4bKnashds9

Max-Forwards: 70

From: <sip:UEa1_public_1@under.test.com>;tag=4fa4

To: <sip:UEa1_public_1@under.test.com>



Contact: <sip:UEa1_public_1@node.under.test.com:1357>;expires=600000
Call-ID: apb03a0s09dkjdfglkj49111@under.test.com
Authorization: Digest username="UEa1_private@under.test.com", realm="under.test.com",
algorithm=AKAv1-MD5, nonce="1U8vpY3qJhiuZNrke/NaponGSCcLm5iR+WCRkWYoM",
uri="sip:under.test.com", response="6629fae49393a05397450978507c4ef1"
Security-Client: ipsec-3gpp; mode="trans"; alg=hmac-sha-1-96; spi-c=23456789; spi-s=12345678;
port-c=2468; port-s=1357
Security-Verify: ipsec-3gpp; alg=hmac-sha-1-96; spi-c=256; spi-s=257; port-c=10002; port-s=10001
Require: sec-agree
Proxy-Require: sec-agree
CSeq: 3 REGISTER
Supported: path
Content-Length: 0

6. 200 OK P-CSCF -> NUT
SIP/2.0 200 OK
Via: SIP/2.0/UDP [3ffe:501:ffff:1000::1000]:1357;branch=z9hG4bKnashds9
From: <sip:UEa1_public_1@under.test.com>;tag=4fa4
To: <sip:UEa1_public_1@under.test.com>;tag=5ef6
Call-ID: apb03a0s09dkjdfglkj49111@under.test.com
Contact: <sip:UEa1_public_1@node.under.test.com:1357>;expires=600000
Path: <sip:term@p.a1.under.test.com;lr>
Service-Route: <sip:orig@s.a1.under.test.com;lr>
CSeq: 3 REGISTER
P-Associated-URI: <sip:UEa1_public_1@under.test.com>
Date: Wed, 11 July 2001 08:49:37 GMT
Content-Length: 0

[OBSERVABLE RESULTS]

*1: 3 REGISTER from NUT to P-CSCF

See generic_REGISTER

Another REGISTER request populating the Expires header field or the expires parameter with an expiration timer of at least the value received in the Min-Expires header field of the 423 (Interval Too Brief) response SHALL be sent.[TS24229-5.1-61]

The client SHOULD NOT retry the same request without modification.
[RFC3261-21.4-1]



*2: 5 REGISTER for authentication from NUT to P-CSCF

See generic_Auth_REGISTER

4.1.8 UE-RG-B-8-AKA - Re-subscription for the registration state event package

[NAME]

UE-RG-B-8-AKA - Re-subscription for the registration state event package

[TARGET]

IMS User Equipment (NUT)

[PURPOSE]

To verify that the UEa1 automatically refreshes the subscription by the reg event package, for a previously registered public user identity when half of the time has expired if the initial subscription was for 1200 seconds or less.

[REFERENCE]

TS24.229 5.1.1.3

[REQUIREMENT]

NONE

[PARAMETER(NUT)]

public-user-id	:	sip:UEa1_public_1@under.test.com
private-user-id	:	UEa1_private@under.test.com
contact_URI	:	sip:UEa1_public_1@node.under.test.com
HOMENETWORK Domain	:	sip:under.test.com

[PARAMETER(TESTER)]

P-CSCFa1	:	sip:p.a1.under.test.com
S-CSCFa1	:	sip:s.a1.under.test.com

[ADDRESS]



UEa1(NUT) : 3ffe:501:fff:1000::1000
 Router(R1) : 3ffe:501:fff:1000::1
 P-CSCFa1 : 3ffe:501:fff:100::10
 I-CSCFa1 : 3ffe:501:fff:100::20
 S-CSCFa1 : 3ffe:501:fff:100::30
 DNS : 3ffe:501:fff:100::40
 DHCP : 3ffe:501:fff:100::50

[TOPOLOGY]

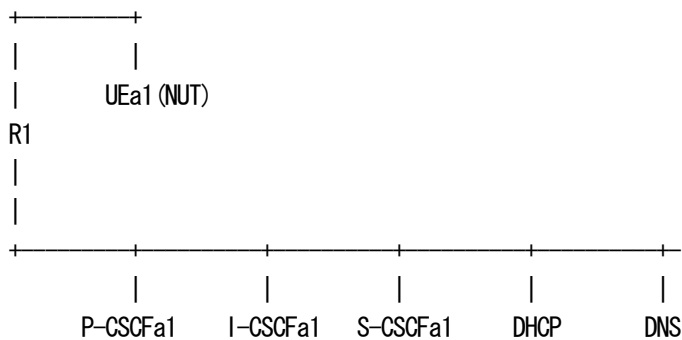

[INITIALIZATION]

Set up IP Address using A or B.

A. Router Advertisement

B. DHCPv6

(NUT)

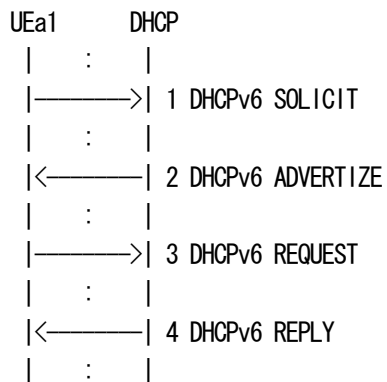

[PROCEDURE]

Home Network



(NUT)

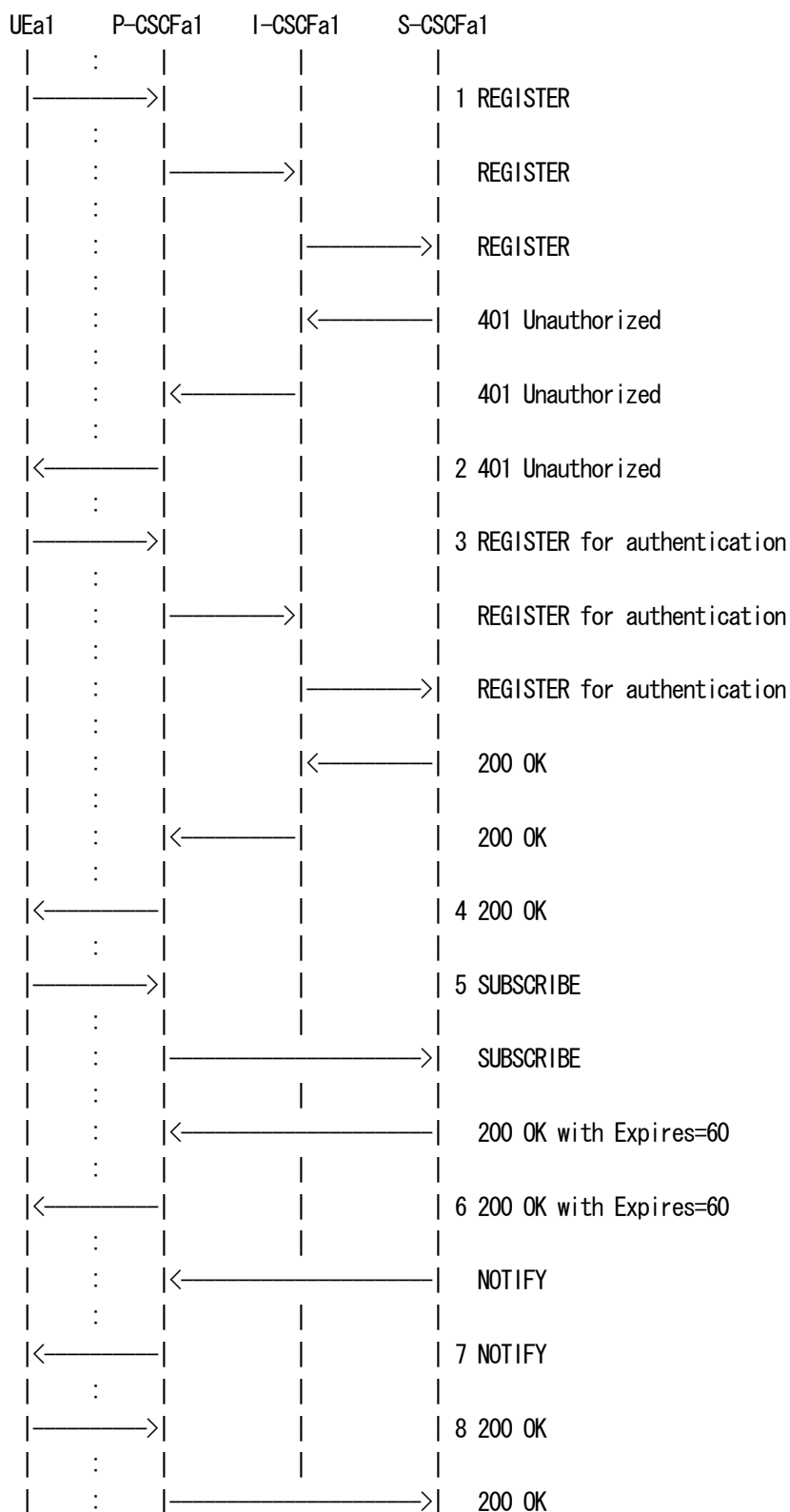

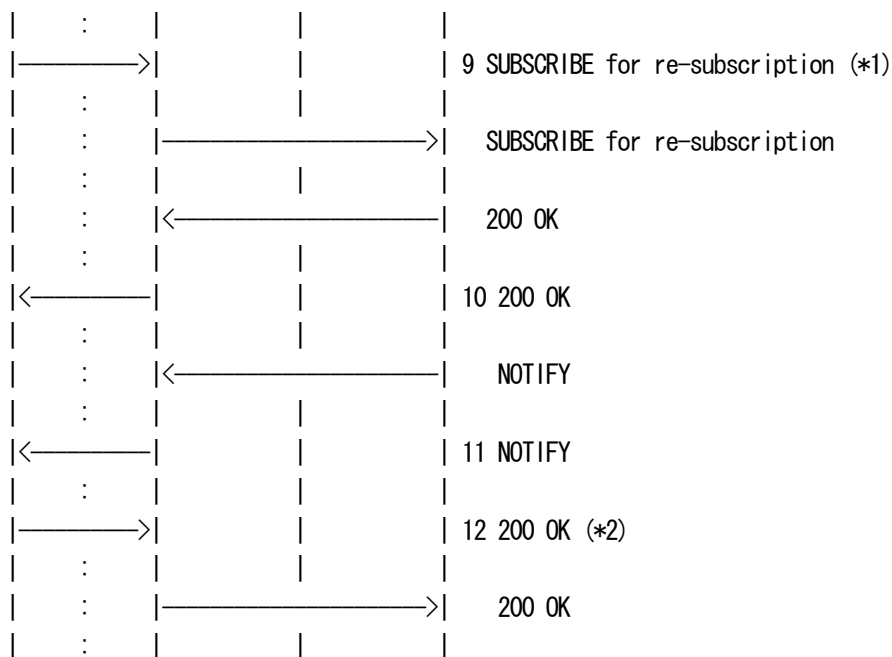

- 1 NUT sends REGISTER
- 2 NUT receives 401 Unauthorized
- 3 NUT sends REGISTER for authentication
- 4 NUT receives 200 OK
- 5 NUT sends SUBSCRIBE with Expires=60
- 6 NUT receives 200 OK
- 7 NUT receives NOTIFY
- 8 NUT sends 200 OK
- 9 NUT sends SUBSCRIBE for re-subscription
- 10 NUT receives 200 OK
- 11 NUT receives NOTIFY
- 12 NUT sends 200 OK

=== Message example ===

As regards the message 1-5, please refer to the message 1-5 in UE-RG-B-1-AKA.

```

6. 200 OK P-CSCF -> NUT
SIP/2.0 200 OK
Via: SIP/2.0/UDP [3ffe:501:fff:1000::1000]:1357;branch=z9hG4bKnashdsa1
Record-Route: <sip:p.a1.under.test.com:10001;lr>
From: <sip:UEa1_public_1@under.test.com>;tag=31415
To: <sip:UEa1_public_1@under.test.com>;tag=151170
Call-ID: b89rjhnedlrjflslj40a222@under.test.com
CSeq: 1 SUBSCRIBE
Contact: <sip:s.a1.under.test.com>

```



Allow-Events: reg
Expires: 60
Content-Length: 0

7. NOTIFY P-CSCF -> NUT

NOTIFY sip:UEa1_public_1@node.under.test.com:1357 SIP/2.0
Via: SIP/2.0/UDP p.a1.under.test.com:10001;branch=z9hG4bK240f34.2,
SIP/2.0/UDP s.a1.under.test.com;branch=z9hG4bK332b23.2;received=3ffe:501:ffff:100::30
Max-Forwards: 69
From: <sip:UEa1_public_1@under.test.com>;tag=151170
To: <sip:UEa1_public_1@under.test.com>;tag=31415
Call-ID: b89rjhnedlrffflslj40a222@under.test.com
CSeq: 2 NOTIFY
Contact: <sip:s.a1.under.test.com>
Subscription-State: active;expires=60
Event: reg
Content-Type: application/reginfo+xml
Content-Length: (...)

```
<?xml version="1.0"?>
<reginfo xmlns="urn:ietf:params:xml:ns:reginfo" version="0" state="full">
  <registration aor="sip:UEa1_public_1@under.test.com" id="a7" state="active">
    <contact id="76" state="active" event="registered">
      <uri>sip:UEa1_public_1@node.under.test.com</uri>
    </contact>
  </registration>
</reginfo>
```

As regards the message 8, please refer to the message 8 in UE-RG-B-1-AKA.

9. SUBSCRIBE NUT -> P-CSCF

SUBSCRIBE sip:s.a1.under.test.com SIP/2.0
Via: SIP/2.0/UDP [3ffe:501:ffff:1000::1000]:1357;branch=z9hG4bKnashdsa2
Max-Forwards: 70
Route: <sip:p.a1.under.test.com:10001;lr>,<sip:orig@s.a1.under.test.com;lr>
From: <sip:UEa1_public_1@under.test.com>;tag=31415
To: <sip:UEa1_public_1@under.test.com>;tag=151170
Require: sec-agree
Proxy-Require: sec-agree
Call-ID: b89rjhnedlrffflslj40a222@under.test.com
CSeq: 2 SUBSCRIBE
Allow-Events: reg
Event: reg



Security-Verify: ipsec-3gpp; alg=hmac-sha-1-96; spi-c=266; spi-s=267; port-c=10002; port-s=10001
Expires: 600000
Contact: <sip:UEa1_public_1@node.under.test.com:1357>
Content-Length: 0

10. 200 OK P-CSCF -> NUT

SIP/2.0 200 OK

Via: SIP/2.0/UDP [3ffe:501:ffff:1000::1000]:1357;branch=z9hG4bKnashdsa2

Record-Route: <sip:p.a1.under.test.com:10001;lr>

From: <sip:UEa1_public_1@under.test.com>;tag=31415

To: <sip:UEa1_public_1@under.test.com>;tag=151170

Call-ID: b89rjhnedlrfflsj40a222@under.test.com

CSeq: 2 SUBSCRIBE

Allow-Events: reg

Expires: 600000

Contact: <sip:s.a1.under.test.com>

Content-Length: 0

11. NOTIFY P-CSCF -> NUT

NOTIFY sip:UEa1_public_1@node.under.test.com:1357 SIP/2.0

Via: SIP/2.0/UDP p.a1.under.test.com:10001;branch=z9hG4bK240f34.2,

SIP/2.0/UDP s.a1.under.test.com;branch=z9hG4bK332b23.2;received=3ffe:501:ffff:100::30

Max-Forwards: 69

From: <sip:UEa1_public_1@under.test.com>;tag=151170

To: <sip:UEa1_public_1@under.test.com>;tag=31415

Call-ID: b89rjhnedlrfflsj40a222@under.test.com

CSeq: 2 NOTIFY

Contact: <sip:s.a1.under.test.com>

Subscription-State: active;expires=600000

Event: reg

Content-Type: application/reginfo+xml

Content-Length: (...)

```
<?xml version="1.0"?>
```

```
<reginfo xmlns="urn:ietf:params:xml:ns:reginfo" version="1" state="full">
```

```
  <registration aor="sip:UEa1_public_1@under.test.com" id="a7" state="active">
```

```
    <contact id="76" state="active" event="registered">
```

```
      <uri>sip:UEa1_public_1@node.under.test.com</uri>
```

```
    </contact>
```

```
  </registration>
```

```
</reginfo>
```



12. 200 OK NUT -> P-CSCF

SIP/2.0 200 OK

Via: SIP/2.0/UDP p.a1.under.test.com:10001;branch=z9hG4bK240f34.2;

received=3ffe:501:ffff:100::10,SIP/2.0/UDP s.a1.under.test.com;

branch=z9hG4bK332b23.2;received=3ffe:501:ffff:100::30

From: <sip:UEa1_public_1@under.test.com>;tag=151170

To: <sip:UEa1_public_1@under.test.com>;tag=31415

Call-ID: b89rjhnedlrjflslj40a222@under.test.com

CSeq: 2 NOTIFY

Content-Length: 0

[OBSERVABLE RESULTS]

*1: 9 SUBSCRIBE for re-subscription from NUT to P-CSCF

See generic_re_SUBSCRIBE

The subscription for a previously registered public user identity SHALL be automatically refreshed either 600 seconds before the expiration time if the initial subscription was for greater than 1200 seconds, or when half of the time has expired if the initial subscription was for 1200 seconds or less.[TS24229-5.1-134]

*2: 12 NOTIFY 200 OK from NUT to P-CSCF

See generic_200-NOTIFY

4.1.9 UE-RG-B-9-AKA - Reception of 481 response to subscription for the registration state event package

[NAME]

UE-RG-B-9-AKA - Reception of 481 response to subscription for the registration state event package

[TARGET]

IMS User Equipment (NUT)

[PURPOSE]



To verify that the UEa1 properly starts a new initial subscription request when the refresh subscription fails with a 481 response.

[REFERENCE]
TS24.229 5.1.1.3

[REQUIREMENT]
NONE

[PARAMETER(NUT)]

public-user-id : sip:UEa1_public_1@under.test.com
private-user-id : UEa1_private@under.test.com
contact_URI : sip:UEa1_public_1@node.under.test.com
HOMENETWORK Domain : sip:under.test.com

[PARAMETER(TESTER)]

P-CSCFa1 : sip:p.a1.under.test.com
S-CSCFa1 : sip:s.a1.under.test.com

[ADDRESS]

UEa1(NUT) : 3ffe:501:ffff:1000::1000
Router(R1) : 3ffe:501:ffff:1000::1
P-CSCFa1 : 3ffe:501:ffff:100::10
I-CSCFa1 : 3ffe:501:ffff:100::20
S-CSCFa1 : 3ffe:501:ffff:100::30
DNS : 3ffe:501:ffff:100::40
DHCP : 3ffe:501:ffff:100::50

[TOPOLOGY]



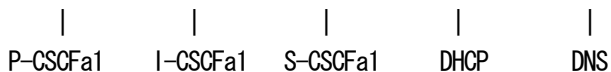

[INITIALIZATION]

Set up IP Address using A or B.

A. Router Advertisement

B. DHCPv6

(NUT)

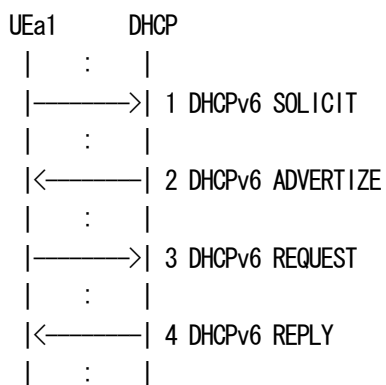

[PROCEDURE]

Home Network

(NUT)

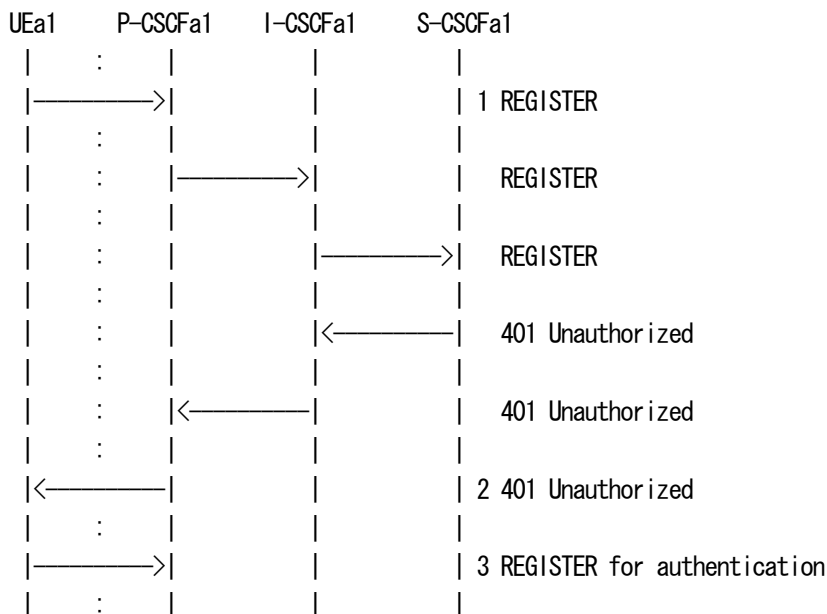

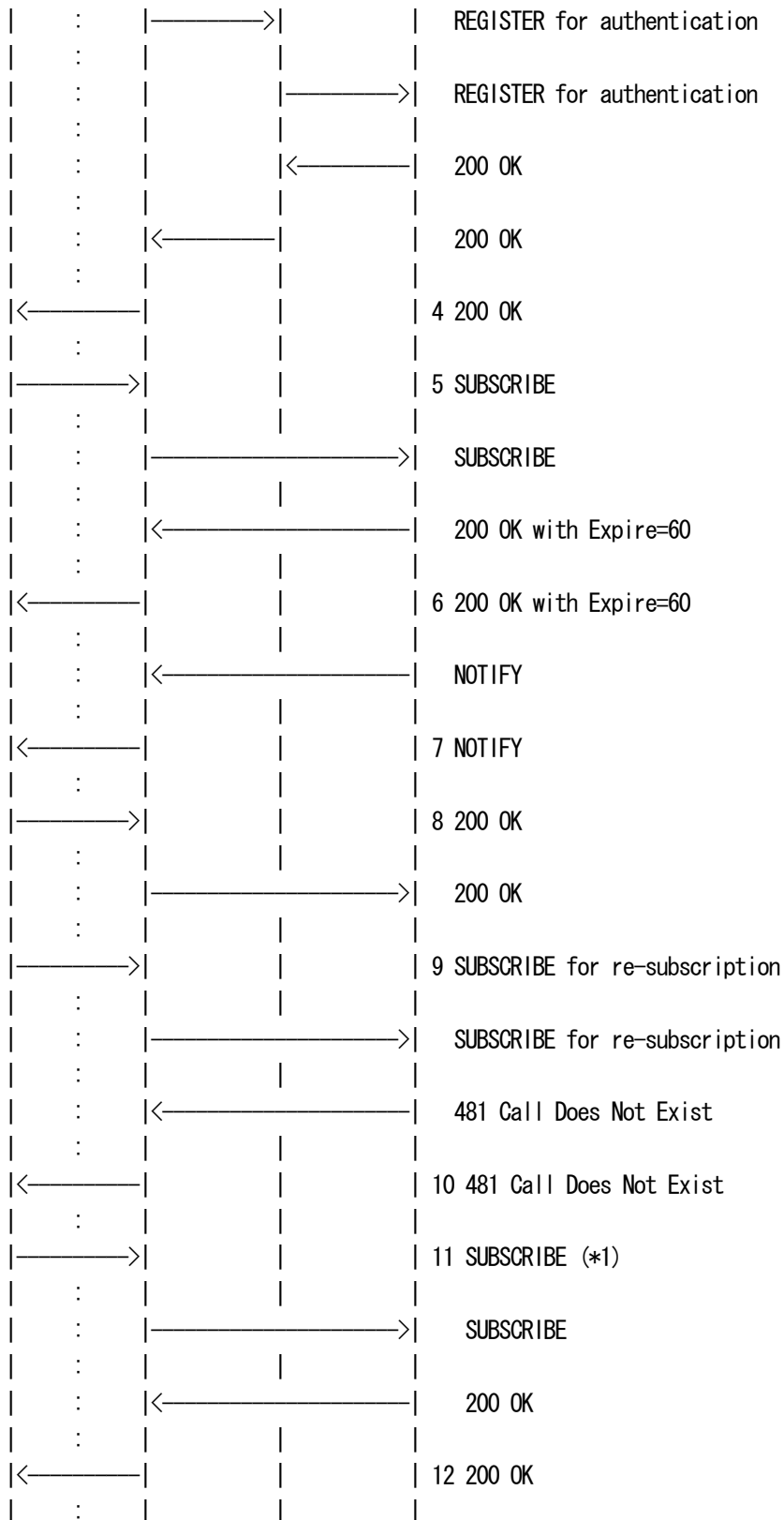

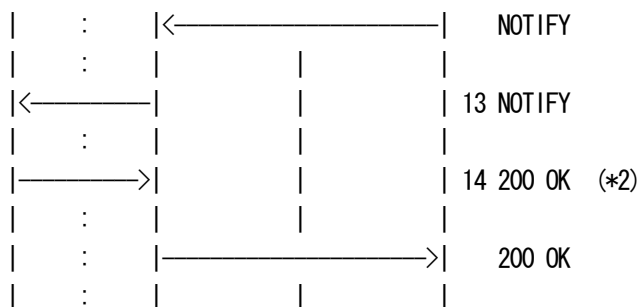

- 1 NUT sends REGISTER
- 2 NUT receives 401 Unauthorized
- 3 NUT sends REGISTER for authentication
- 4 NUT receives 200 OK
- 5 NUT sends SUBSCRIBE
- 6 NUT receives 200 OK
- 7 NUT receives NOTIFY
- 8 NUT sends 200 OK
- 9 NUT sends SUBSCRIBE for re-subscription
- 10 NUT receives 481 Call Does Not Exist
- 11 NUT sends SUBSCRIBE
- 12 NUT receives 200 OK
- 13 NUT receives NOTIFY
- 14 NUT sends 200 OK

=== Message example ===

As regards the message 1-9, please refer to the message 1-9 in UE-RG-B-8-AKA.

10. 481 Call Does Not Exist P-CSCF -> NUT
 SIP/2.0 481 Subscription Does Not Exist
 Via: SIP/2.0/UDP [3ffe:501:ffff:1000::1000]:1357;branch=z9hG4bKnashdsa2
 From: <sip:UEa1_public_1@under.test.com>;tag=31415
 To: <sip:UEa1_public_1@under.test.com>;tag=151170
 Call-ID: b89rjhnedlrfjflsj40a222@under.test.com
 CSeq: 2 SUBSCRIBE
 Content-Length: 0

11. SUBSCRIBE NUT -> P-CSCF
 SUBSCRIBE sip:UEa1_public_1@under.test.com SIP/2.0
 Via: SIP/2.0/UDP [3ffe:501:ffff:1000::1000]:1357;branch=z9hG4bKnashdsb1
 Max-Forwards: 70
 Route: <sip:p.a1.under.test.com:10001;lr>,<sip:orig@s.a1.under.test.com;lr>
 From: <sip:UEa1_public_1@under.test.com>;tag=41415



To: <sip:UEa1_public_1@under.test.com>
Require: sec-agree
Proxy-Require: sec-agree
Call-ID: c89rjhnedlrfjfsj40a222@under.test.com
CSeq: 1 SUBSCRIBE
Allow-Events: reg
Event: reg
Security-Verify: ipsec-3gpp; alg=hmac-sha-1-96; spi-c=256; spi-s=257; port-c=10002; port-s=10001
Expires: 600000
Contact: <sip:UEa1_public_1@node.under.test.com:1357>
Content-Length: 0

12. 200 OK P-CSCF -> NUT

SIP/2.0 200 OK

Via: SIP/2.0/UDP [3ffe:501:ffff:1000::1000]:1357;branch=z9hG4bKnashdsb1

Record-Route: <sip:p.a1.under.test.com:10001;lr>

From: <sip:UEa1_public_1@under.test.com>;tag=41415

To: <sip:UEa1_public_1@under.test.com>;tag=251170

Call-ID: c89rjhnedlrfjfsj40a222@under.test.com

CSeq: 1 SUBSCRIBE

Allow-Events: reg

Expires: 600000

Contact: <sip:s.a1.under.test.com>

Content-Length: 0

13. NOTIFY P-CSCF -> NUT

NOTIFY sip:UEa1_public_1@node.under.test.com:1357 SIP/2.0

Via: SIP/2.0/UDP p.a1.under.test.com:10001;branch=z9hG4bK240f82.1,

SIP/2.0/UDP s.a1.under.test.com;branch=z9hG4bK332b56.1;received=3ffe:501:ffff:100::30

Max-Forwards: 69

From: <sip:UEa1_public_1@under.test.com>;tag=251170

To: <sip:UEa1_public_1@under.test.com>;tag=41415

Call-ID: c89rjhnedlrfjfsj40a222@under.test.com

CSeq: 1 NOTIFY

Contact: <sip:s.a1.under.test.com>

Subscription-State: active;expires=600000

Event: reg

Content-Type: application/reginfo+xml

Content-Length: (...)

<?xml version="1.0"?>



```
<reginfo xmlns="urn:ietf:params:xml:ns:reginfo" version="0" state="full">
  <registration aor="sip:UEa1_public_1@under.test.com" id="a7" state="active">
    <contact id="76" state="active" event="registered">
      <uri>sip:UEa1_public_1@node.under.test.com</uri>
    </contact>
  </registration>
</reginfo>
```

14. 200 OK NUT -> P-CSCF

SIP/2.0 200 OK

Via: SIP/2.0/UDP p.a1.under.test.com:10001;branch=z9hG4bK240f82.1;received=3ffe:501:ffff:100::10,

SIP/2.0/UDP s.a1.under.test.com;branch=z9hG4bK332b56.1;received=3ffe:501:ffff:100::30

From: <sip:UEa1_public_1@under.test.com>;tag=251170

To: <sip:UEa1_public_1@under.test.com>;tag=41415

Call-ID: c89rjhnedlrfjlsj40a222@under.test.com

CSeq: 1 NOTIFY

Content-Length: 0

[OBSERVABLE RESULTS]

*1: 11 SUBSCRIBE from NUT to P-CSCF

See generic_SUBSCRIBE

The UAC SHOULD terminate the dialog.[RFC3261-12.2-23]

*2: 14 NOTIFY 200 OK from NUT to P-CSCF

See generic_200-NOTIFY

4.1.10 UE-RG-B-10-AKA - Reception of a new service-route to reregistration

[NAME]

UE-RG-B-10-AKA - Reception of a new service-route to reregistration

[TARGET]

IMS User Equipment (NUT)

[PURPOSE]



To verify that the UEa1 stores the list of Service-Route headers contained in the Service-Route header, in order to build a proper preloaded Route header value for new dialogs and standalone transactions.

[REFERENCE]
TS24229 5.1.1.4.1

[REQUIREMENT]
NONE

[PARAMETER(NUT)]

public-user-id : sip:UEa1_public_1@under.test.com
private-user-id : UEa1_private@under.test.com
contact_URI : sip:UEa1_public_1@node.under.test.com
HOMENETWORK Domain : sip:under.test.com

[PARAMETER(TESTER)]

public-user-id(UEa2) : sip:UEa2_public_1@under.test.com
P-CSCFa1 : sip:p.a1.under.test.com
S-CSCFa1 : sip:s.a1.under.test.com
S-CSCFa3 : sip:s.a3.under.test.com

[ADDRESS]

UEa1(NUT) : 3ffe:501:fff:1000::1000
Router(R1) : 3ffe:501:fff:1000::1
P-CSCFa1 : 3ffe:501:fff:100::10
I-CSCFa1 : 3ffe:501:fff:100::20
S-CSCFa1 : 3ffe:501:fff:100::30
S-CSCFa3 : 3ffe:501:fff:300::30
DNS : 3ffe:501:fff:100::40
DHCP : 3ffe:501:fff:100::50
UEa2 : 3ffe:501:fff:2000::1000
P-CSCFa2 : 3ffe:501:fff:200::10
I-CSCFa2 : 3ffe:501:fff:200::20
S-CSCFa2 : 3ffe:501:fff:200::30

[TOPOLOGY]

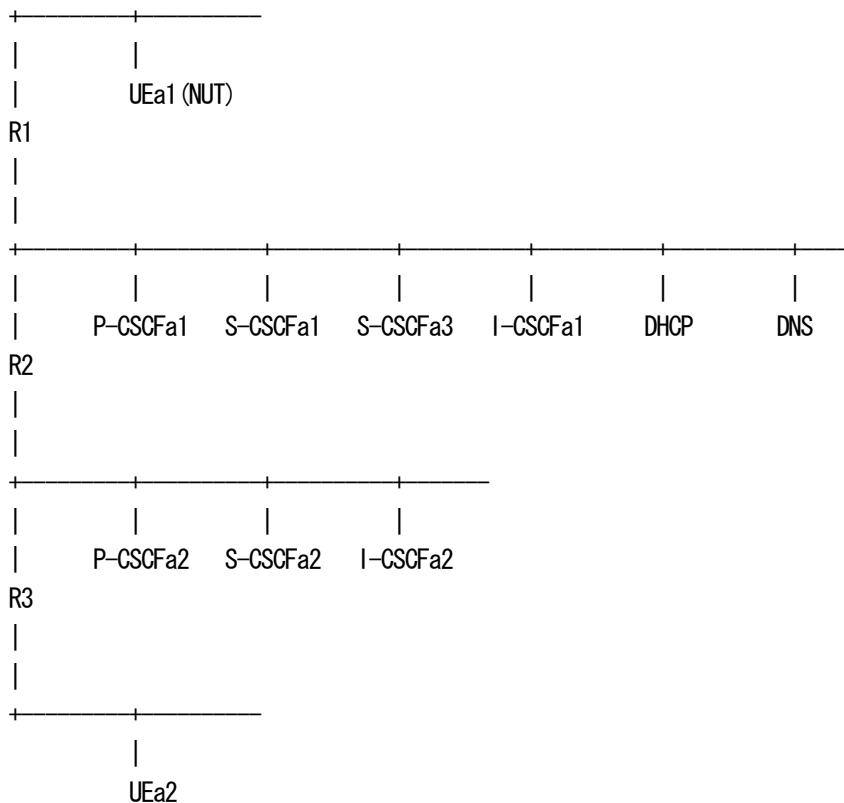

[INITIALIZATION]

Set up IP Address using A or B.

A. Router Advertisement

B. DHCPv6

(NUT)

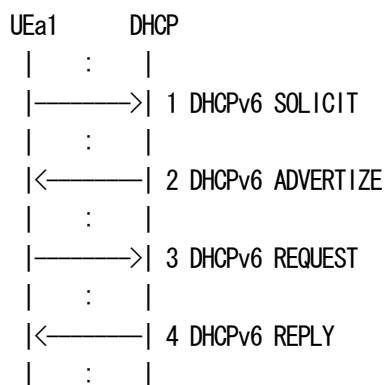

[PROCEDURE]

Home Network

(NUT)

UEa1	P-CSCFa1	S-CSCFa1	I-CSCFa1	S-CSCFa3	I-CSCFa2	S-CSCFa2	P-CSCFa2	UEa2
	:							
	→							1 REGISTER
	:							
	:		→					REGISTER
	:							
	:		←					REGISTER
	:							
	:		→					401 Unauthorized
	:							
	:		←					401 Unauthorized
	:							
	←							2 401 Unauthorized
	:							
	→							3 REGISTER for authentication
	:							
	:		→					REGISTER for authentication
	:							
	:		←					REGISTER for authentication
	:							
	:		→					200 OK with expires=60
	:							
	:		←					200 OK with expires=60
	:							
	←							4 200 OK with expires=60
	:							
	→							5 SUBSCRIBE
	:							
	:		→					SUBSCRIBE
	:							
	:		←					200 OK
	:							
	←							6 200 OK
	:							
	:		←					NOTIFY
	:							
	←							7 NOTIFY
	:							
	→							8 200 OK
	:							
	:		→					200 OK
	:							

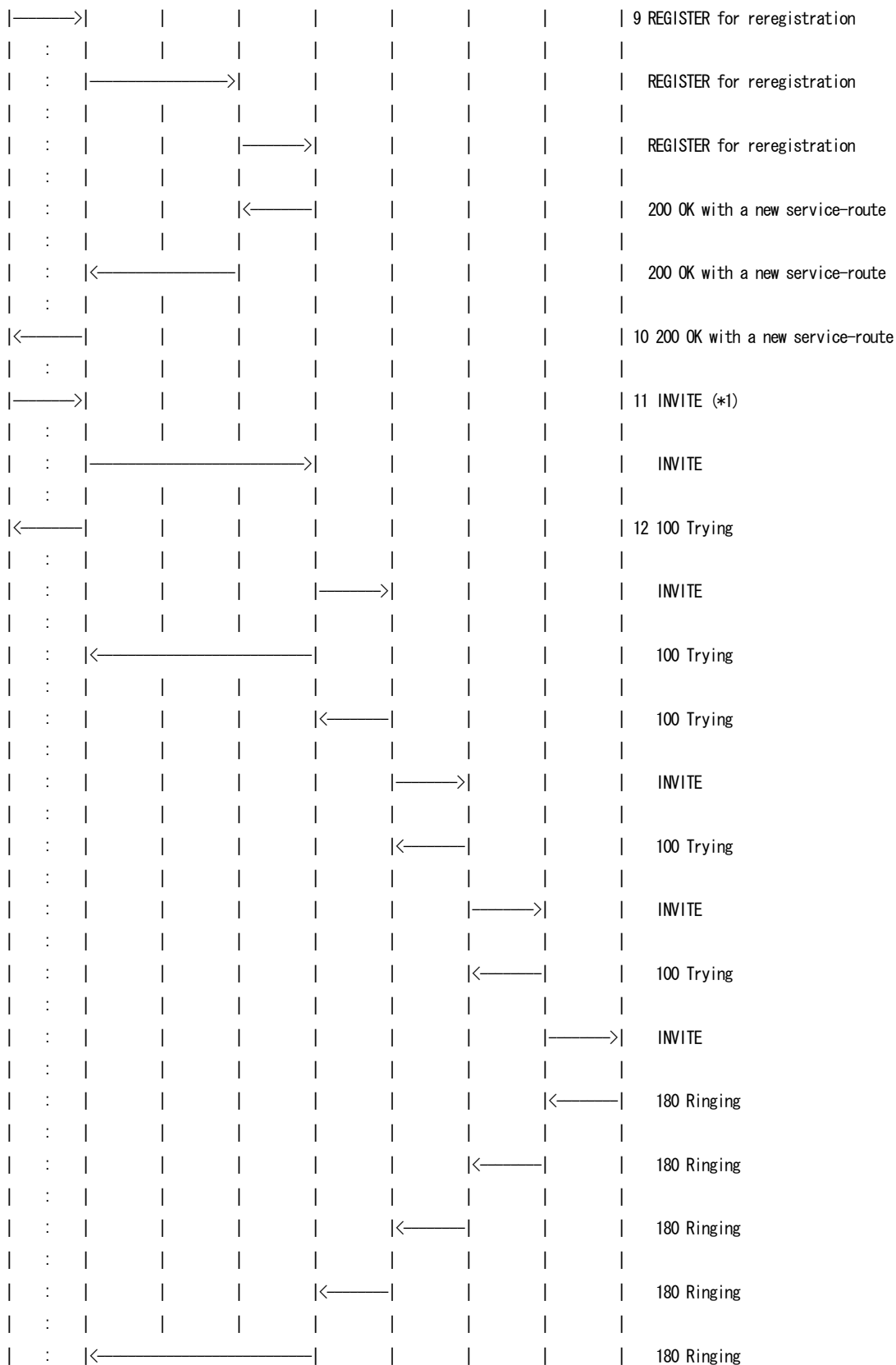

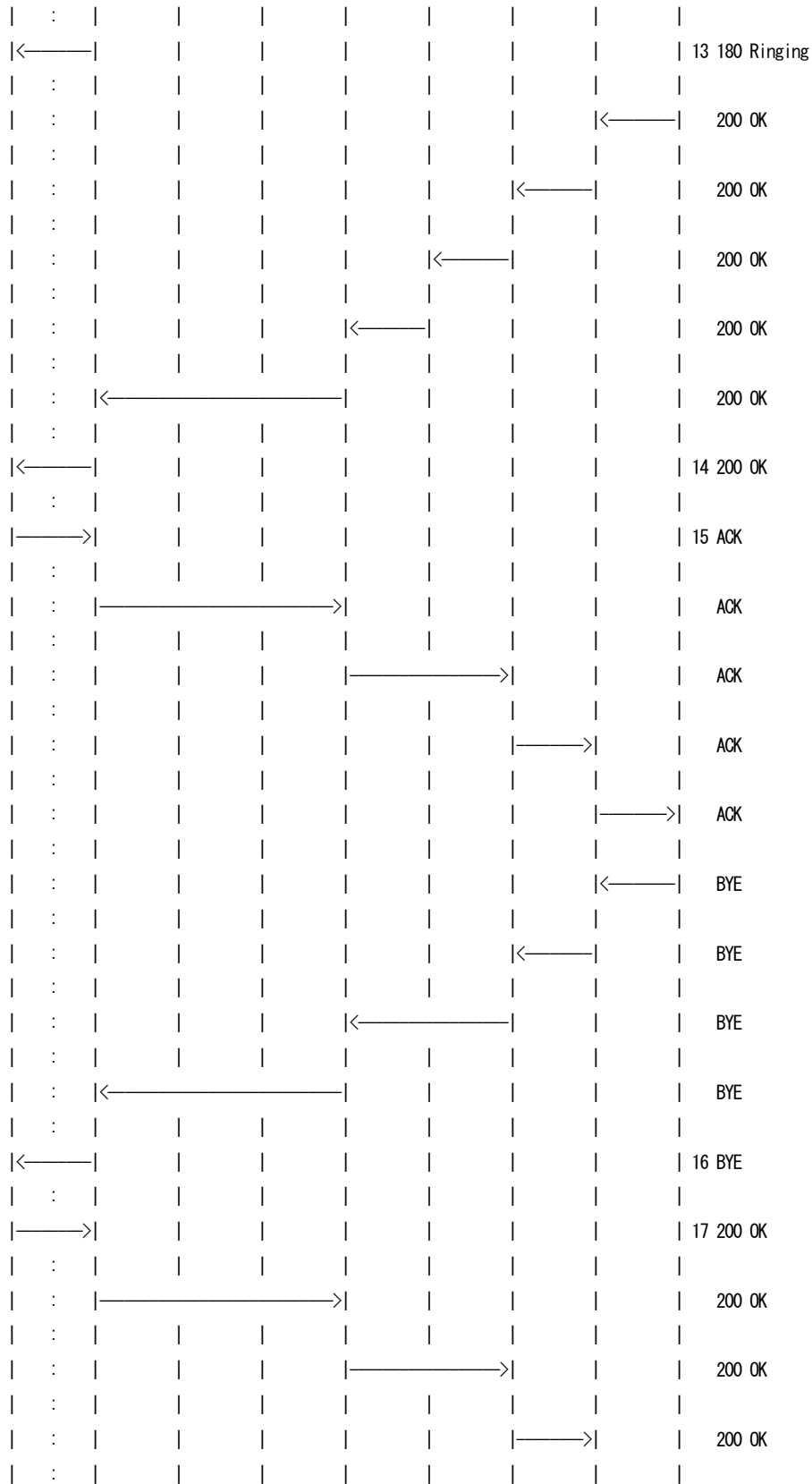



| : | | | | | | | |—————>| 200 OK
| : | | | | | | | | | |

- 1 NUT sends REGISTER
- 2 NUT receives 401 Unauthorized
- 3 NUT sends REGISTER for authentication
- 4 NUT receives 200 OK
- 5 NUT sends SUBSCRIBE
- 6 NUT receives 200 OK
- 7 NUT receives NOTIFY
- 8 NUT sends 200 OK
- 9 NUT sends REGISTER for reregistration
- 10 NUT receives 200 OK with a new Service-Route Header from S-CSCFa3
- 11 NUT sends INVITE
- 12 NUT receives 100 Trying
- 13 NUT receives 180 Ringing
- 14 NUT receives 200 OK
- 15 NUT sends ACK
- 16 NUT receives BYE
- 17 NUT sends 200 OK

=== Message example ===

As regards the message 1-9, please refer to the message 1-9 in UE-RG-B-2-AKA.

10. 200 OK P-CSCF -> NUT

SIP/2.0 200 OK

Via: SIP/2.0/UDP [3ffe:501:ffff:1000::1000]:1357;branch=z9hG4bKnashds9

From: <sip:UEa1_public_1@under.test.com>;tag=4fa4

To: <sip:UEa1_public_1@under.test.com>;tag=5ef6

Call-ID: apb03a0s09dkjdfglkj49111@under.test.com

Contact: <sip:UEa1_public_1@node.under.test.com:1357>;expires=600000

Path: <sip:term@p.a1.under.test.com;lr>

Service-Route: <sip:orig@s.a3.under.test.com;lr>

P-Associated-URI: <sip:UEa1_public_1@under.test.com>

CSeq: 3 REGISTER

Date: Wed, 11 July 2001 08:50:08 GMT

Content-Length: 0

11. INVITE NUT -> P-CSCF

INVITE sip:UEa2_public_1@under.test.com SIP/2.0

Via: SIP/2.0/UDP [3ffe:501:ffff:1000::1000]:1357;branch=z9hG4bK74bf9

Route: <sip:p.a1.under.test.com:10001;lr>,<sip:orig@s.a3.under.test.com;lr>



Max-Forwards: 70
From: <sip:UEa1_public_1@under.test.com>;tag=9fxced76sl
To: <sip:UEa2_public_1@under.test.com>
Call-ID: 3848276298220188511@under.test.com
CSeq: 1 INVITE
Contact: <sip:UEa1_public_1@node.under.test.com:1357>
Supported:
Allow: INVITE,ACK,CANCEL,OPTIONS,BYE
Allow-Events: reg
Accept: application/sdp,application/3gpp-ims+xml
Require: sec-agree
Proxy-Require: sec-agree
Security-Verify: ipsec-3gpp; alg=hmac-sha-1-96; spi-c=256; spi-s=257; port-c=10002; port-s=10001
Content-Type: application/sdp
Content-Length: 154

v=0
o=UEa1 2890844526 2890844526 IN IP6 node.under.test.com
s=-
c=IN IP6 node.under.test.com
t=0 0
m=audio 49172 RTP/AVP 0
b=AS:75
a=rtpmap:0 PCMU/8000

12. 100 Trying P-CSCF -> NUT
SIP/2.0 100 Trying
Via: SIP/2.0/UDP [3ffe:501:ffff:1000::1000]:1357;branch=z9hG4bK74bf9
From: <sip:UEa1_public_1@under.test.com>;tag=9fxced76sl
To: <sip:UEa2_public_1@under.test.com>
Call-ID: 3848276298220188511@under.test.com
CSeq: 1 INVITE
Content-Length: 0

13. 180 Ringing P-CSCF -> NUT
SIP/2.0 180 Ringing
Via: SIP/2.0/UDP [3ffe:501:ffff:1000::1000]:1357;branch=z9hG4bK74bf9
From: <sip:UEa1_public_1@under.test.com>;tag=9fxced76sl
To: <sip:UEa2_public_1@under.test.com>;tag=314259
Call-ID: 3848276298220188511@under.test.com
CSeq: 1 INVITE



Content-Length: 0

14. 200 OK P-CSCF -> NUT

SIP/2.0 200 OK

Via: SIP/2.0/UDP [3ffe:501:ffff:1000::1000]:1357;branch=z9hG4bK74bf9

Record-Route: <sip:p.a2.under.test.com;lr>,<sip:s.a2.under.test.com;lr>,<sip:s.a3.under.test.com;lr>,<sip:p.a1.under.test.com:10001;lr>

From: <sip:UEa1_public_1@under.test.com>;tag=9fxced76sl

To: <sip:UEa2_public_1@under.test.com>;tag=314259

Call-ID: 3848276298220188511@under.test.com

CSeq: 1 INVITE

Contact: <sip:UEa2_public_1@nodea2.under.test.com:22222>

Supported:

Allow: INVITE,ACK,CANCEL,OPTIONS,BYE

Allow-Events: reg

Content-Type: application/sdp

Content-Length: 153

v=0

o=UEa2 2890844527 2890844527 IN IP6 nodea2.under.test.com

s=-

c=IN IP6 nodea2.under.test.com

t=0 0

m=audio 3456 RTP/AVP 0

b=AS:75

a=rtpmap:0 PCMU/8000

15. ACK NUT -> P-CSCF

ACK sip:UEa2_public_1@nodea2.under.test.com:22222 SIP/2.0

Via: SIP/2.0/UDP [3ffe:501:ffff:1000::1000]:1357;branch=z9hG4bK74bf10

Route: <sip:p.a1.under.test.com:10001;lr>,<sip:s.a3.under.test.com;lr>,<sip:s.a2.under.test.com;lr>,<sip:p.a2.under.test.com;lr>

Max-Forwards: 70

From: <sip:UEa1_public_1@under.test.com>;tag=9fxced76sl

To: <sip:UEa2_public_1@under.test.com>;tag=314259

Call-ID: 3848276298220188511@under.test.com

CSeq: 1 ACK

Content-Length: 0

16. BYE P-CSCF -> NUT



BYE sip:UEa1_public_1@node.under.test.com:1357 SIP/2.0
Via: SIP/2.0/UDP p.a1.under.test.com:10001;branch=z9hG4bK431e418c501,
SIP/2.0/UDP s.a3.under.test.com;branch=z9hG4bKnashdsa2.3;received=3ffe:501:ffff:300::30,
SIP/2.0/UDP s.a2.under.test.com;branch=z9hG4bK721e418c9.1;received=3ffe:501:ffff:200::30,
SIP/2.0/UDP p.a2.under.test.com;branch=z9hG4bKnaghds30;received=3ffe:501:ffff:200::10,
SIP/2.0/UDP [3ffe:501:ffff:2000::1000]:22222;branch=z9hG4bKnashdsb3
Max-Forwards: 66
From: <sip:UEa2_public_1@under.test.com>;tag=314259
To: <sip:UEa1_public_1@under.test.com>;tag=9fxced76sl
Call-ID: 3848276298220188511@under.test.com
CSeq: 2 BYE
Content-Length: 0

17. 200 OK NUT -> P-CSCF

SIP/2.0 200 OK
Via: SIP/2.0/UDP p.a1.under.test.com:10001;branch=z9hG4bK431e418c501;received=3ffe:501:ffff:100::10,
SIP/2.0/UDP s.a3.under.test.com;branch=z9hG4bKnashdsa2.3;received=3ffe:501:ffff:300::30,
SIP/2.0/UDP s.a2.under.test.com;branch=z9hG4bK721e418c9.1;received=3ffe:501:ffff:200::30,
SIP/2.0/UDP p.a2.under.test.com;branch=z9hG4bKnaghds30;received=3ffe:501:ffff:200::10,
SIP/2.0/UDP [3ffe:501:ffff:2000::1000]:22222;branch=z9hG4bKnashdsb3
From: <sip:UEa2_public_1@under.test.com>;tag=314259
To: <sip:UEa1_public_1@under.test.com>;tag=9fxced76sl
Call-ID: 3848276298220188511@under.test.com
CSeq: 2 BYE
Content-Length: 0

[OBSERVABLE RESULTS]

*1: 11 INVITE from NUT to P-CSCF

See generic_INVITE

4.1.11 UE-RG-B-11-AKA - Reception of 423 response to reregistration

[NAME]

UE-RG-B-11-AKA - Reception of 423 response to reregistration

[TARGET]

IMS User Equipment (NUT)



[PURPOSE]

To verify that the UEa1 properly sends another REGISTER request populating the Expires header or the expires parameter with an expiration timer of at least the value received in the Min-Expires header of the 423 (Interval Too Brief) response.

[REFERENCE]

TS24229 5.1.1.4.1

[REQUIREMENT]

NONE

[PARAMETER(NUT)]

public-user-id : sip:UEa1_public_1@under.test.com
private-user-id : UEa1_private@under.test.com
contact_URI : sip:UEa1_public_1@node.under.test.com
HOMENETWORK Domain : sip:under.test.com

[PARAMETER(TESTER)]

P-CSCFa1 : sip:p.a1.under.test.com
S-CSCFa1 : sip:s.a1.under.test.com

[ADDRESS]

UEa1(NUT) : 3ffe:501:fff:1000::1000
Router(R1) : 3ffe:501:fff:1000::1
P-CSCFa1 : 3ffe:501:fff:100::10
I-CSCFa1 : 3ffe:501:fff:100::20
S-CSCFa1 : 3ffe:501:fff:100::30
DNS : 3ffe:501:fff:100::40
DHCP : 3ffe:501:fff:100::50

[TOPOLOGY]

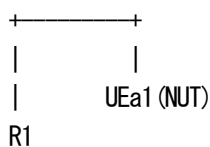

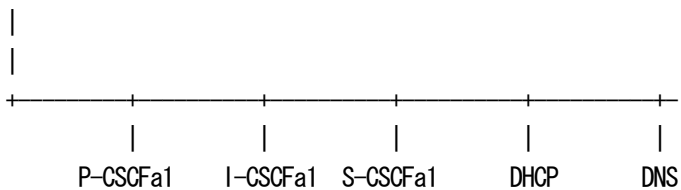

[INITIALIZATION]

Set up IP Address using A or B.

A. Router Advertisement

B. DHCPv6

(NUT)

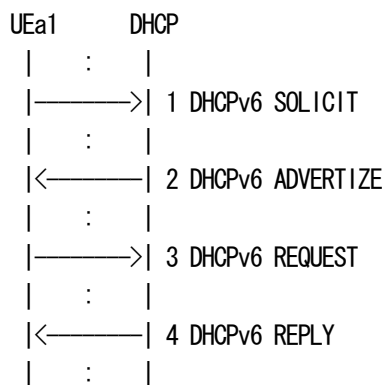

[PROCEDURE]

Home Network

(NUT)

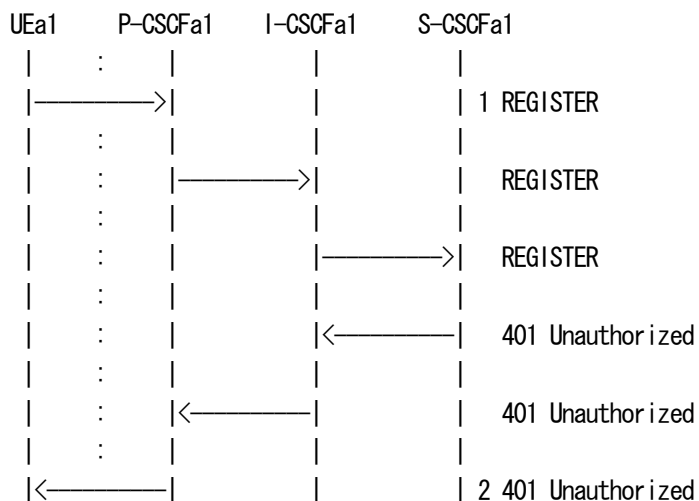

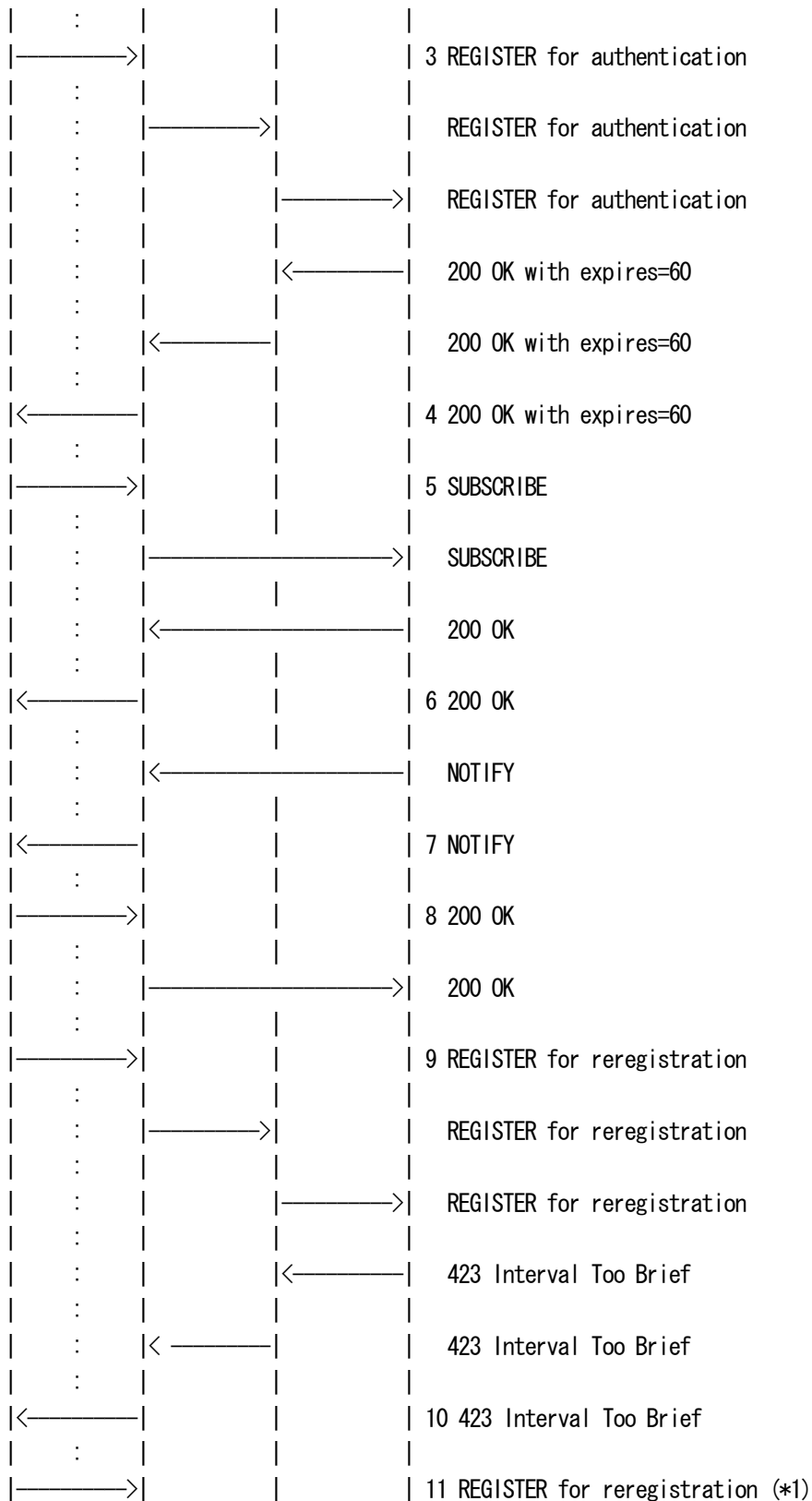

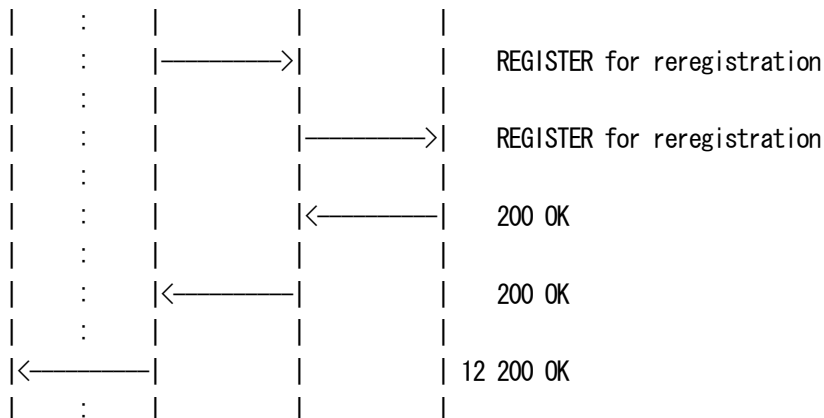

- 1 NUT sends REGISTER
- 2 NUT receives 401 Unauthorized
- 3 NUT sends REGISTER for authentication
- 4 NUT receives 200 OK
- 5 NUT sends SUBSCRIBE
- 6 NUT receives 200 OK
- 7 NUT receives NOTIFY
- 8 NUT sends 200 OK
- 9 NUT sends REGISTER for reregistration
- 10 NUT receives 423 Interval Too Brief
- 11 NUT sends REGISTER for reregistration
- 12 NUT receives 200 OK

=== Message example ===

As regards the message 1-9, please refer to the message 1-9 in UE-RG-B-2-AKA.

10. 423 Interval Too Brief P-CSCF -> NUT
 SIP/2.0 423 Interval Too Brief
 Via: SIP/2.0/UDP [3ffe:501:ffff:1000::1000]:1357;branch=z9hG4bKnashds9
 From: <sip:UEa1_public_1@under.test.com>;tag=4fa4
 To: <sip:UEa1_public_1@under.test.com>;tag=5ef6
 Call-ID: apb03a0s09dkjdfglkj49111@under.test.com
 CSeq: 3 REGISTER
 Min-Expires: 600000
 Content-Length: 0

11. REGISTER NUT -> P-CSCF
 REGISTER sip:under.test.com SIP/2.0
 Via: SIP/2.0/UDP [3ffe:501:ffff:1000::1000]:1357;branch=z9hG4bKnashds10
 Max-Forwards: 70



From: <sip:UEa1_public_1@under.test.com>;tag=4fa5
To: <sip:UEa1_public_1@under.test.com>
Contact: <sip:UEa1_public_1@node.under.test.com:1357>;expires=600000
Call-ID: apb03a0s09dkjdfglkj49111@under.test.com
Authorization: Digest username="UEa1_private@under.test.com", realm="under.test.com",
nonce="11U8vpY3qJhiuZNRke/NaponGSCclm5iR+WCRkWYoM", uri="sip:under.test.com",
response="6629fae49393a05397450978507c4ef1"
Security-Client: ipsec-3gpp; mode="trans"; alg=hmac-sha-1-96; spi-c=33456789; spi-s=22345678;
port-c=3468; port-s=1357
Security-Verify: ipsec-3gpp; alg=hmac-sha-1-96; spi-c=256; spi-s=257; port-c=10002; port-s=10001
Require: sec-agree
Proxy-Require: sec-agree
CSeq: 4 REGISTER
Supported: path
Content-Length: 0

12. 200 OK P-CSCF -> NUT
SIP/2.0 200 OK
Via: SIP/2.0/UDP [3ffe:501:ffff:1000::1000]:1357;branch=z9hG4bKnashds10
From: <sip:UEa1_public_1@under.test.com>;tag=4fa5
To: <sip:UEa1_public_1@under.test.com>;tag=5ef7
Call-ID: apb03a0s09dkjdfglkj49111@under.test.com
Contact: <sip:UEa1_public_1@node.under.test.com:1357>;expires=600000
Path: <sip:term@p.a1.under.test.com;lr>
Service-Route: <sip:orig@s.a1.under.test.com;lr>
CSeq: 4 REGISTER
P-Associated-URI: <sip:UEa1_public_1@under.test.com>
Date: Wed, 11 July 2001 08:50:08 GMT
Content-Length: 0

[OBSERVABLE RESULTS]

*1: 11 REGISTER for reregistration from NUT to P-CSCF

See generic_re_REGISTER

The client SHOULD NOT retry the same request without modification.
[RFC3261-21.4-1]

- Header field:

* Contact expires parameter/Expires



Another REGISTER request SHALL be sent the registration expiration interval value with an expiration time of at least the value received in Min-Expire header field of 423(Interval Too Brief) respons.[TS24229-5.1-171]

4.1.12 UE-RG-B-12-AKA - Reception of 408 response to reregistration

[NAME]

UE-RG-B-12-AKA - Reception of 408 response to reregistration

[TARGET]

IMS User Equipment (NUT)

[PURPOSE]

To verify that the UEa1 properly performs the procedures for initial registration after received 408 (Request Timeout) response.

[REFERENCE]

TS24.229 5.1.1.2.1

TS24.229 5.1.1.2.2

TS24.229 5.1.1.3

TS24.229 5.1.1.4.1

TS24.229 5.1.1.4.2

TS24.229 5.1.1.5.1

[REQUIREMENT]

NONE

[PARAMETER(NUT)]

public-user-id : sip:UEa1_public_1@under.test.com

private-user-id : UEa1_private@under.test.com

contact_URI : sip:UEa1_public_1@node.under.test.com

HOMENETWORK Domain : sip:under.test.com

[PARAMETER(TESTER)]

P-CSCFa1 : sip:p.a1.under.test.com

S-CSCFa1 : sip:s.a1.under.test.com



[ADDRESS]

UEa1(NUT) : 3ffe:501:fff:1000::1000
Router(R1) : 3ffe:501:fff:1000::1
P-CSCFa1 : 3ffe:501:fff:100::10
I-CSCFa1 : 3ffe:501:fff:100::20
S-CSCFa1 : 3ffe:501:fff:100::30
DNS : 3ffe:501:fff:100::40
DHCP : 3ffe:501:fff:100::50

[TOPOLOGY]

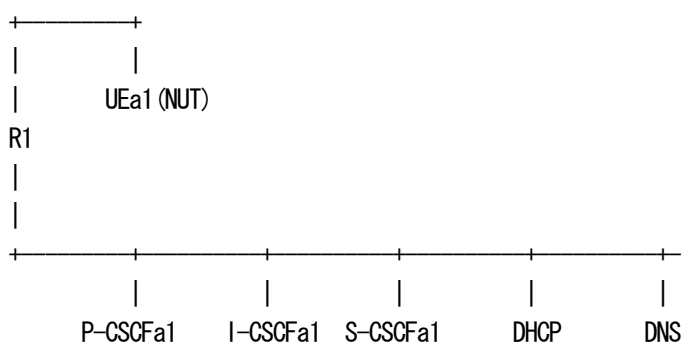

[INITIALIZATION]

Set up IP Address using A or B.

A. Router Advertisement

B. DHCPv6

(NUT)

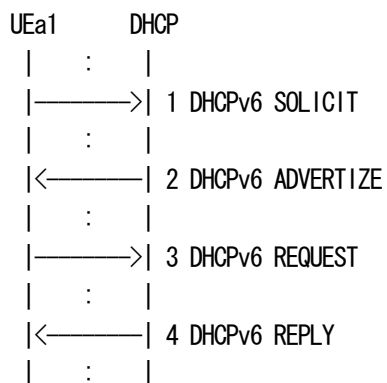

[PROCEDURE]

Home Network

(NUT)

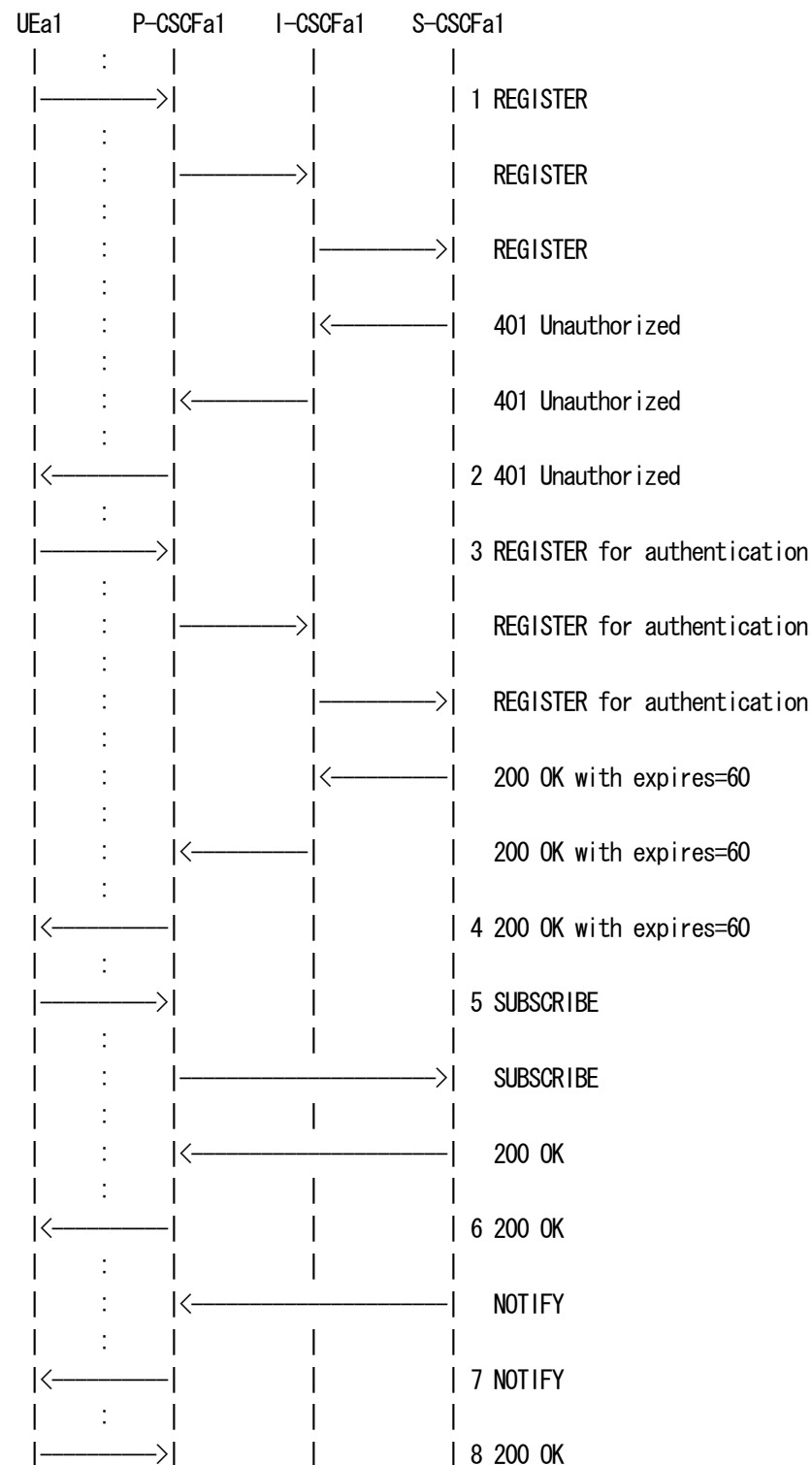

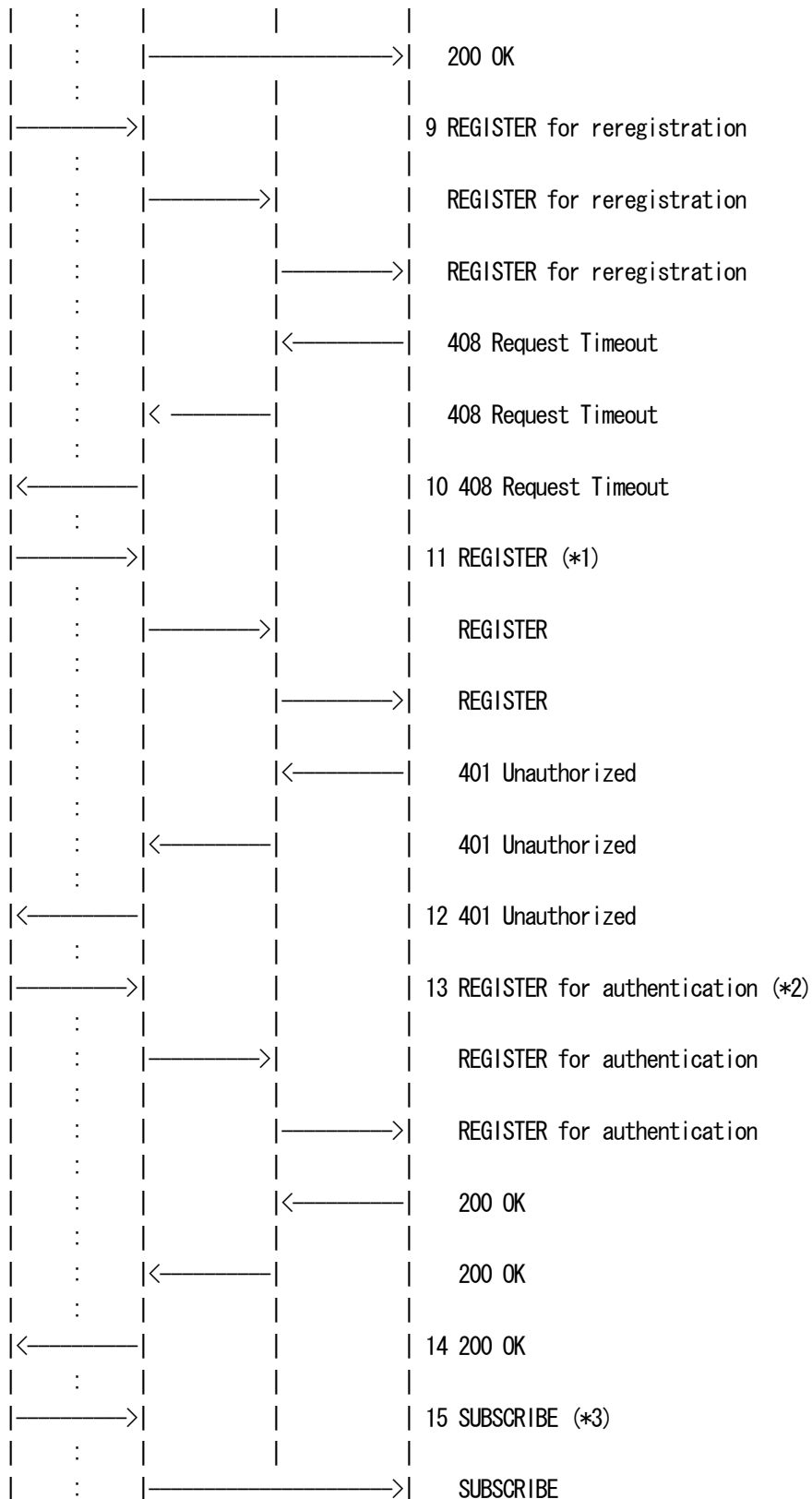

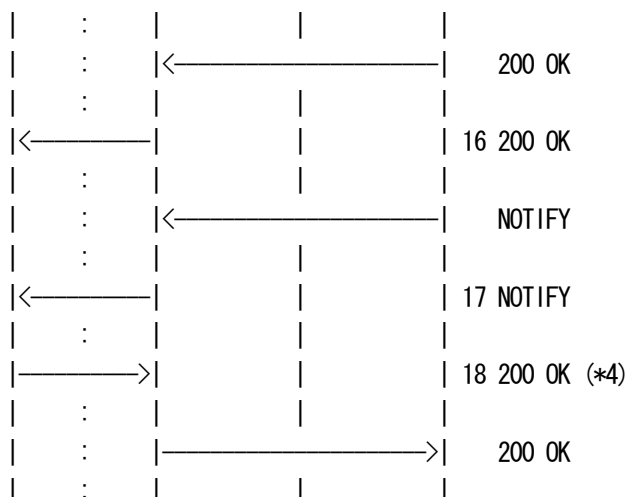

- 1 NUT sends REGISTER
- 2 NUT receives 401 Unauthorized
- 3 NUT sends REGISTER for authentication
- 4 NUT receives 200 OK
- 5 NUT sends SUBSCRIBE
- 6 NUT receives 200 OK
- 7 NUT receives NOTIFY
- 8 NUT sends 200 OK
- 9 NUT sends REGISTER
- 10 NUT receives 408 Request Timeout
- 11 NUT sends REGISTER
- 12 NUT receives 401 Unauthorized
- 13 NUT sends REGISTER for authentication
- 14 NUT receives 200 OK
- 15 NUT sends SUBSCRIBE
- 16 NUT receives 200 OK
- 17 NUT receives NOTIFY
- 18 NUT sends 200 OK

=== Message example ===

As regards the message 1-9, please refer to the message 1-9 in UE-RG-B-2-AKA.

10. 408 Request Timeout P-CSCF -> NUT

SIP/2.0 408 Request Timeout

Via: SIP/2.0/UDP [3ffe:501:ffff:1000::1000]:1357;branch=z9hG4bKnashds9

From: <sip:UEa1_public_1@under.test.com>;tag=4fa4

To: <sip:UEa1_public_1@under.test.com>;tag=5ef6

Call-ID: apb03a0s09dkjdfgkj49111@under.test.com

CSeq: 3 REGISTER



Content-Length: 0

11. REGISTER NUT -> P-CSCF

REGISTER sip:under.test.com SIP/2.0

Via: SIP/2.0/UDP [3ffe:501:ffff:1000::1000]:1357;branch=z9hG4bKnashdt7

Max-Forwards: 70

From: <sip:UEa1_public_1@under.test.com>;tag=5fa3

To: <sip:UEa1_public_1@under.test.com>

Contact: <sip:UEa1_public_1@node.under.test.com:1357>;expires=600000

Call-ID: bpb03a0s09dkjdfglkj49111@under.test.com

Authorization: Digest username="UEa1_private@under.test.com", realm="under.test.com", nonce="", uri="sip:under.test.com", response=""

Security-Client: ipsec-3gpp; mode="trans"; alg=hmac-sha-1-96; spi-c=33456789; spi-s=22345678; port-c=3468; port-s=1357

Require: sec-agree

Proxy-Require: sec-agree

CSeq: 1 REGISTER

Supported: path

Content-Length: 0

12. 401 Unauthorized P-CSCF -> NUT

SIP/2.0 401 Unauthorized

Via: SIP/2.0/UDP [3ffe:501:ffff:1000::1000]:1357;branch=z9hG4bKnashdt7

WWW-Authenticate: Digest realm="under.test.com",

nonce="J2U8vpY3qJhiuZNRke/ObponGSCcLm5iR+WCRkWYoM", algorithm=AKAv1-MD5

From: <sip:UEa1_public_1@under.test.com>;tag=5fa3

To: <sip:UEa1_public_1@under.test.com>;tag=6ef4

Call-ID: bpb03a0s09dkjdfglkj49111@under.test.com

Security-Server: ipsec-3gpp; alg=hmac-sha-1-96; spi-c=266; spi-s=267; port-c=10004; port-s=10001

CSeq: 1 REGISTER

Content-Length: 0

13. REGISTER NUT -> P-CSCF

REGISTER sip:under.test.com SIP/2.0

Via: SIP/2.0/UDP [3ffe:501:ffff:1000::1000]:1357;branch=z9hG4bKnashdt8

Max-Forwards: 70

From: <sip:UEa1_public_1@under.test.com>;tag=5fa3

To: <sip:UEa1_public_1@under.test.com>

Contact: <sip:UEa1_public_1@node.under.test.com:1357>;expires=600000

Call-ID: bpb03a0s09dkjdfglkj49111@under.test.com



Authorization: Digest username="UEa1_private@under.test.com", realm="under.test.com",
algorithm=AKAv1-MD5, nonce="J2U8vpY3qJhiuZNRke/ObponGSCcLm5iR+WCRkWYoM",
uri="sip:under.test.com", response="7729fae49393a05397450978507c4ef2"
Security-Client: ipsec-3gpp; mode="trans"; alg=hmac-sha-1-96; spi-c=33456789; spi-s=22345678;
port-c=3468; port-s=1357
Security-Verify: ipsec-3gpp; alg=hmac-sha-1-96; spi-c=266; spi-s=267; port-c=10004; port-s=10001
Require: sec-agree
Proxy-Require: sec-agree
CSeq: 2 REGISTER
Supported: path
Content-Length: 0

14. 200 OK P-CSCF -> NUT

SIP/2.0 200 OK
Via: SIP/2.0/UDP [3ffe:501:ffff:1000::1000]:1357;branch=z9hG4bKnashdt8
From: <sip:UEa1_public_1@under.test.com>;tag=5fa3
To: <sip:UEa1_public_1@under.test.com>;tag=6ef5
Call-ID: bpb03a0s09dkjdfglkj49111@under.test.com
Contact: <sip:UEa1_public_1@node.under.test.com:1357>;expires=600000
Path: <sip:term@p.a1.under.test.com;lr>
Service-Route: <sip:orig@s.a1.under.test.com;lr>
CSeq: 2 REGISTER
P-Associated-URI: <sip:UEa1_public_1@under.test.com>
Date: Wed, 11 July 2001 08:49:37 GMT
Content-Length: 0

15. SUBSCRIBE NUT -> P-CSCF

SUBSCRIBE sip:UEa1_public_1@under.test.com SIP/2.0
Via: SIP/2.0/UDP [3ffe:501:ffff:1000::1000]:1357;branch=z9hG4bKnashdsb1
Max-Forwards: 70
Route: <sip:p.a1.under.test.com:10001;lr>, <sip:orig@s.a1.under.test.com;lr>
From: <sip:UEa1_public_1@under.test.com>;tag=41415
To: <sip:UEa1_public_1@under.test.com>
Require: sec-agree
Proxy-Require: sec-agree
Call-ID: c89rjhnedlrfjflsj40a222@under.test.com
CSeq: 1 SUBSCRIBE
Allow-Events: reg
Event: reg
Security-Verify: ipsec-3gpp; alg=hmac-sha-1-96; spi-c=266; spi-s=267; port-c=10004; port-s=10001
Expires: 600000



Contact: <sip:UEa1_public_1@node.under.test.com:1357>
Content-Length: 0

16. 200 OK P-CSCF -> NUT
SIP/2.0 200 OK
Via: SIP/2.0/UDP [3ffe:501:ffff:1000::1000]:1357;branch=z9hG4bKnashdsb1
Record-Route: <sip:p.a1.under.test.com:10001;lr>
From: <sip:UEa1_public_1@under.test.com>;tag=41415
To: <sip:UEa1_public_1@under.test.com>;tag=251170
Call-ID: c89rjhnedlrfjfsj40a222@under.test.com
CSeq: 1 SUBSCRIBE
Allow-Events: reg
Expires: 600000
Contact: <sip:s.a1.under.test.com>
Content-Length: 0

17. NOTIFY P-CSCF -> NUT
NOTIFY sip:UEa1_public_1@node.under.test.com:1357 SIP/2.0
Via: SIP/2.0/UDP p.a1.under.test.com:10001;branch=z9hG4bK240f82.1,
SIP/2.0/UDP s.a1.under.test.com;branch=z9hG4bK332b56.1;received=3ffe:501:ffff:100::30
Max-Forwards: 69
From: <sip:UEa1_public_1@under.test.com>;tag=251170
To: <sip:UEa1_public_1@under.test.com>;tag=41415
Call-ID: c89rjhnedlrfjfsj40a222@under.test.com
CSeq: 1 NOTIFY
Contact: <sip:s.a1.under.test.com>
Subscription-State: active;expires=600000
Event: reg
Content-Type: application/reginfo+xml
Content-Length: (...)

```
<?xml version="1.0"?>
<reginfo xmlns="urn:ietf:params:xml:ns:reginfo" version="0" state="full">
  <registration aor="sip:UEa1_public_1@under.test.com" id="a7" state="active">
    <contact id="76" state="active" event="registered">
      <uri>sip:UEa1_public_1@node.under.test.com</uri>
    </contact>
  </registration>
</reginfo>
```



18. 200 OK NUT -> P-CSCF

SIP/2.0 200 OK

Via: SIP/2.0/UDP p.a1.under.test.com:10001;branch=z9hG4bK240f82.1;received=3ffe:501:ffff:100::10,

SIP/2.0/UDP s.a1.under.test.com;branch=z9hG4bK332b56.1;received=3ffe:501:ffff:100::30

From: <sip:UEa1_public_1@under.test.com>;tag=251170

To: <sip:UEa1_public_1@under.test.com>;tag=41415

Call-ID: c89rjhnedlrfjflsj40a222@under.test.com

CSeq: 1 NOTIFY

Content-Length: 0

[OBSERVABLE RESULTS]

*1: 11 REGISTER from NUT to P-CSCF

See generic_REGISTER

*2: 13 REGISTER for authentication from NUT to P-CSCF

See generic_Auth_REGISTER

*3: 15 SUBSCRIBE from NUT to P-CSCF

See generic_SUBSCRIBE

*4: 18 NOTIFY 200 OK from NUT to P-CSCF

See generic_200-NOTIFY

4.1.13 UE-RG-B-13-AKA - Reception of 500 response to reregistration

[NAME]

UE-RG-B-13-AKA - Reception of 500 response to reregistration

[TARGET]

IMS User Equipment (NUT)

[PURPOSE]

To verify that the UEa1 properly perform the procedures for initial registration after received 500 (Server Internal) response.



[REFERENCE]

- TS24.229 5.1.1.2.1
- TS24.229 5.1.1.2.2
- TS24.229 5.1.1.3
- TS24.229 5.1.1.4.1
- TS24.229 5.1.1.5.1

[REQUIREMENT]

NONE

[PARAMETER(NUT)]

public-user-id : sip:UEa1_public_1@under.test.com
private-user-id : UEa1_private@under.test.com
contact_URI : sip:UEa1_public_1@node.under.test.com
HOMENETWORK Domain : sip:under.test.com

[PARAMETER(TESTER)]

P-CSCFa1 : sip:p.a1.under.test.com
S-CSCFa1 : sip:s.a1.under.test.com

[ADDRESS]

UEa1(NUT) : 3ffe:501:fff:1000::1000
Router(R1) : 3ffe:501:fff:1000::1
P-CSCFa1 : 3ffe:501:fff:100::10
I-CSCFa1 : 3ffe:501:fff:100::20
S-CSCFa1 : 3ffe:501:fff:100::30
DNS : 3ffe:501:fff:100::40
DHCP : 3ffe:501:fff:100::50

[TOPOLOGY]

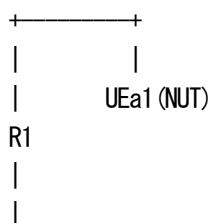

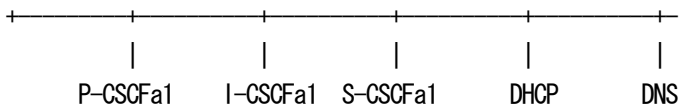

[INITIALIZATION]

Set up IP Address using A or B.

A. Router Advertisement

B. DHCPv6

(NUT)

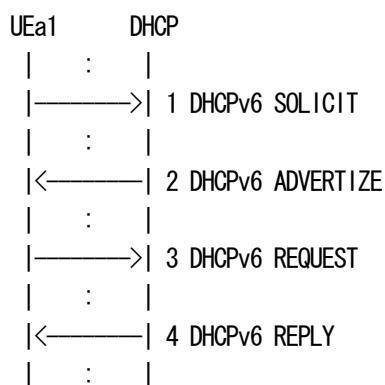

[PROCEDURE]

Home Network

(NUT)

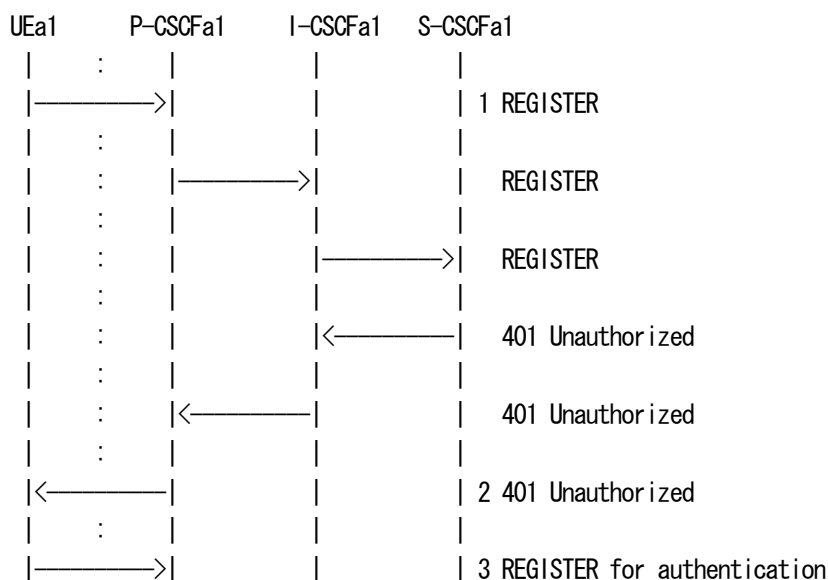

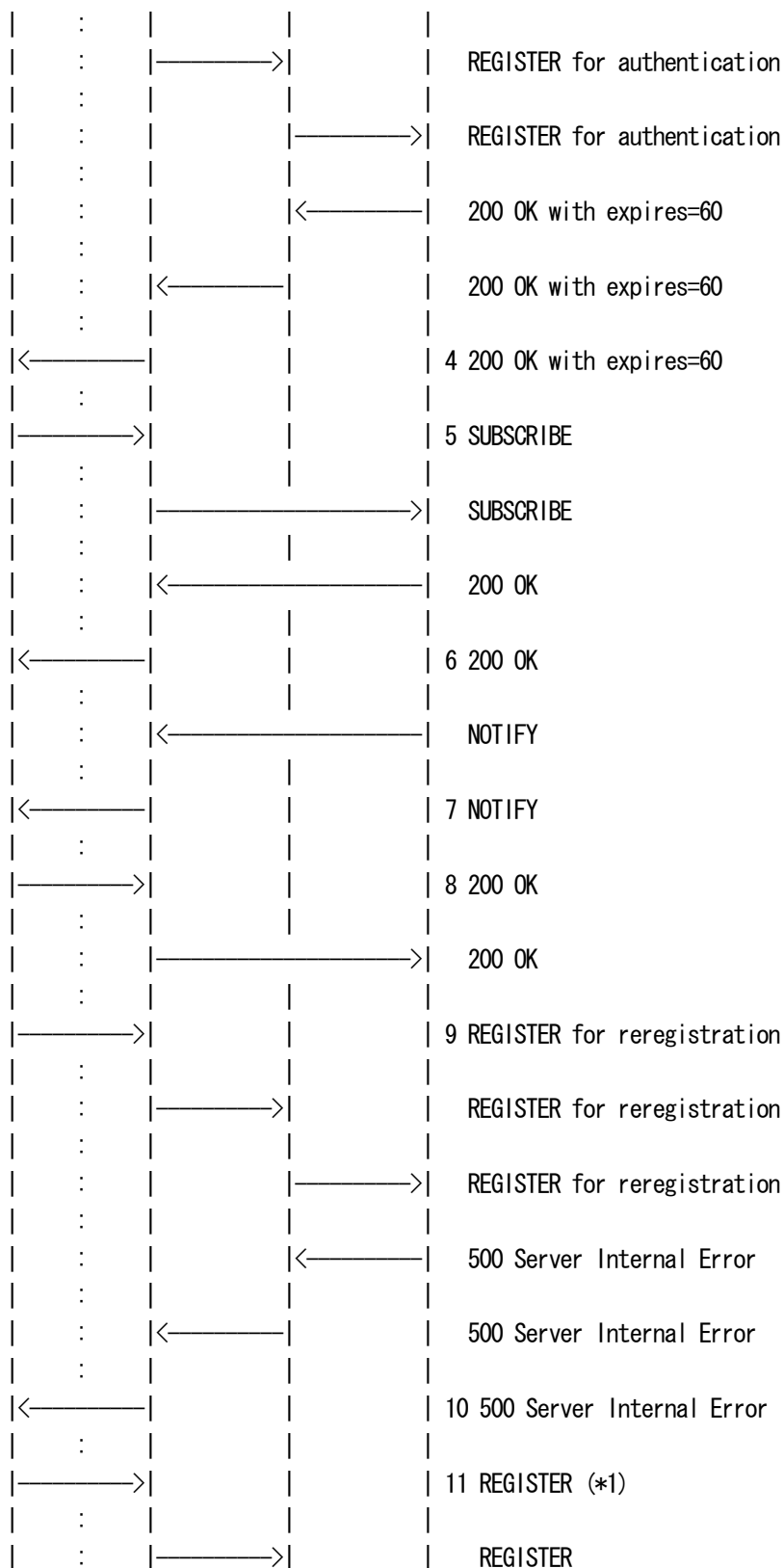

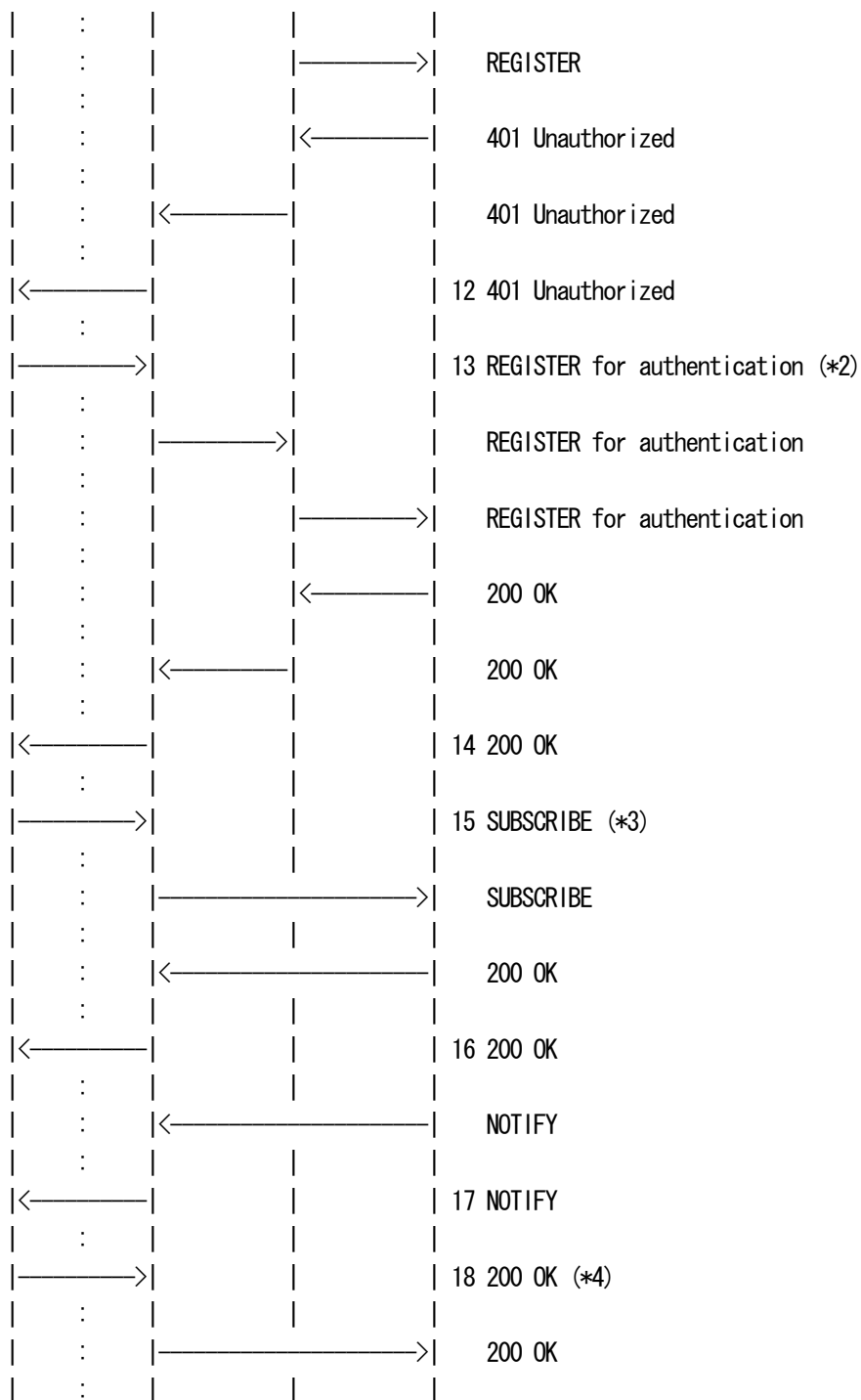

- 1 NUT sends REGISTER
- 2 NUT receives 401 Unauthorized
- 3 NUT sends REGISTER for authentication
- 4 NUT receives 200 OK
- 5 NUT sends SUBSCRIBE



6 NUT receives 200 OK
7 NUT receives NOTIFY
8 NUT sends 200 OK
9 NUT sends REGISTER for reregistration
10 NUT receives 500 Server Internal Error
11 NUT sends REGISTER
12 NUT receives 401 Unauthorized
13 NUT sends REGISTER for authentication
14 NUT receives 200 OK
15 NUT sends SUBSCRIBE
16 NUT receives 200 OK
17 NUT receives NOTIFY
18 NUT sends 200 OK

=== Message example ===

As regards the message 1-9, please refer to the message 1-9 in UE-RG-B-2-AKA.

10. 500 Server Internal Error P-CSCF -> NUT
SIP/2.0 500 Server Internal Error
Via: SIP/2.0/UDP [3ffe:501:ffff:1000::1000]:1357;branch=z9hG4bKnashds9
From: <sip:UEa1_public_1@under.test.com>;tag=4fa4
To: <sip:UEa1_public_1@under.test.com>;tag=5ef6
Call-ID: apb03a0s09dkjdfglkj49111@under.test.com
CSeq: 3 REGISTER
Content-Length: 0

11. REGISTER NUT -> P-CSCF
REGISTER sip:under.test.com SIP/2.0
Via: SIP/2.0/UDP [3ffe:501:ffff:1000::1000]:1357;branch=z9hG4bKnashdt7
Max-Forwards: 70
From: <sip:UEa1_public_1@under.test.com>;tag=5fa3
To: <sip:UEa1_public_1@under.test.com>
Contact: <sip:UEa1_public_1@node.under.test.com:1357>;expires=600000
Call-ID: bpb03a0s09dkjdfglkj49111@under.test.com
Authorization: Digest username="UEa1_private@under.test.com", realm="under.test.com", nonce="",
uri="sip:under.test.com", response=""
Security-Client: ipsec-3gpp; mode="trans"; alg=hmac-sha-1-96; spi-c=33456789; spi-s=22345678;
port-c=3468; port-s=1357
Require: sec-agree
Proxy-Require: sec-agree
CSeq: 1 REGISTER
Supported: path
Content-Length: 0



12. 401 Unauthorized P-CSCF -> NUT

SIP/2.0 401 Unauthorized

Via: SIP/2.0/UDP [3ffe:501:ffff:1000::1000]:1357;branch=z9hG4bKnashdt7

WWW-Authenticate: Digest realm="under.test.com",

nonce="J2U8vpY3qJhiuZNRke/ObponGSCcLm5iR+WCRkWYoM", algorithm=AKAv1-MD5

From: <sip:UEa1_public_1@under.test.com>;tag=5fa3

To: <sip:UEa1_public_1@under.test.com>;tag=6ef4

Call-ID: bpb03a0s09dkjdfglkj49111@under.test.com

Security-Server: ipsec-3gpp; alg=hmac-sha-1-96; spi-c=266; spi-s=267; port-c=10004; port-s=10001

CSeq: 1 REGISTER

Content-Length: 0

13. REGISTER NUT -> P-CSCF

REGISTER sip:under.test.com SIP/2.0

Via: SIP/2.0/UDP [3ffe:501:ffff:1000::1000]:1357;branch=z9hG4bKnashdt8

Max-Forwards: 70

From: <sip:UEa1_public_1@under.test.com>;tag=5fa3

To: <sip:UEa1_public_1@under.test.com>

Contact: <sip:UEa1_public_1@node.under.test.com:1357>;expires=600000

Call-ID: bpb03a0s09dkjdfglkj49111@under.test.com

Authorization: Digest username="UEa1_private@under.test.com", realm="under.test.com",

algorithm=AKAv1-MD5, nonce="J2U8vpY3qJhiuZNRke/ObponGSCcLm5iR+WCRkWYoM",

uri="sip:under.test.com", response="7729fae49393a05397450978507c4ef2"

Security-Client: ipsec-3gpp; mode="trans"; alg=hmac-sha-1-96; spi-c=33456789; spi-s=22345678;

port-c=3468; port-s=1357

Security-Verify: ipsec-3gpp; alg=hmac-sha-1-96; spi-c=266; spi-s=267; port-c=10004; port-s=10001

Require: sec-agree

Proxy-Require: sec-agree

CSeq: 2 REGISTER

Supported: path

Content-Length: 0

14. 200 OK P-CSCF -> NUT

SIP/2.0 200 OK

Via: SIP/2.0/UDP [3ffe:501:ffff:1000::1000]:1357;branch=z9hG4bKnashdt8

From: <sip:UEa1_public_1@under.test.com>;tag=5fa3

To: <sip:UEa1_public_1@under.test.com>;tag=6ef5

Call-ID: bpb03a0s09dkjdfglkj49111@under.test.com

Contact: <sip:UEa1_public_1@node.under.test.com:1357>;expires=600000



Path: <sip:term@p.a1.under.test.com;lr>
Service-Route: <sip:orig@s.a1.under.test.com;lr>
CSeq: 2 REGISTER
P-Associated-URI: <sip:UEa1_public_1@under.test.com>
Date: Wed, 11 July 2001 08:49:37 GMT
Content-Length: 0

15. SUBSCRIBE NUT -> P-CSCF

SUBSCRIBE sip:UEa1_public_1@under.test.com SIP/2.0
Via: SIP/2.0/UDP [3ffe:501:ffff:1000::1000]:1357;branch=z9hG4bKnashdsb1
Max-Forwards: 70
Route: <sip:p.a1.under.test.com:10001;lr>,<sip:orig@s.a1.under.test.com;lr>
From: <sip:UEa1_public_1@under.test.com>;tag=41415
To: <sip:UEa1_public_1@under.test.com>
Require: sec-agree
Proxy-Require: sec-agree
Call-ID: c89rjhnedlrfjflslj40a222@under.test.com
CSeq: 1 SUBSCRIBE
Allow-Events: reg
Event: reg
Security-Verify: ipsec-3gpp; alg=hmac-sha-1-96; spi-c=266; spi-s=267; port-c=10004; port-s=10001
Expires: 600000
Contact: <sip:UEa1_public_1@node.under.test.com:1357>
Content-Length: 0

16. 200 OK P-CSCF -> NUT

SIP/2.0 200 OK
Via: SIP/2.0/UDP [3ffe:501:ffff:1000::1000]:1357;branch=z9hG4bKnashdsb1
Record-Route: <sip:p.a1.under.test.com:10001;lr>
From: <sip:UEa1_public_1@under.test.com>;tag=41415
To: <sip:UEa1_public_1@under.test.com>;tag=251170
Call-ID: c89rjhnedlrfjflslj40a222@under.test.com
CSeq: 1 SUBSCRIBE
Allow-Events: reg
Expires: 600000
Contact: <sip:s.a1.under.test.com>
Content-Length: 0

17. NOTIFY P-CSCF -> NUT

NOTIFY sip:UEa1_public_1@node.under.test.com:1357 SIP/2.0



Via: SIP/2.0/UDP p.a1.under.test.com:10001;branch=z9hG4bK240f82.1,
SIP/2.0/UDP s.a1.under.test.com;branch=z9hG4bK332b56.1;received=3ffe:501:ffff:100::30
Max-Forwards: 69
From: <sip:UEa1_public_1@under.test.com>;tag=251170
To: <sip:UEa1_public_1@under.test.com>;tag=41415
Call-ID: c89rjhnedlrfjfsj40a222@under.test.com
CSeq: 1 NOTIFY
Contact: <sip:s.a1.under.test.com>
Subscription-State: active;expires=600000
Event: reg
Content-Type: application/reginfo+xml
Content-Length: (...)

```
<?xml version="1.0"?>
<reginfo xmlns="urn:ietf:params:xml:ns:reginfo" version="0" state="full">
  <registration aor="sip:UEa1_public_1@under.test.com" id="a7" state="active">
    <contact id="76" state="active" event="registered">
      <uri>sip:UEa1_public_1@node.under.test.com</uri>
    </contact>
  </registration>
</reginfo>
```

18. 200 OK NUT -> P-CSCF

SIP/2.0 200 OK

Via: SIP/2.0/UDP p.a1.under.test.com:10001;branch=z9hG4bK240f82.1;received=3ffe:501:ffff:100::10,
SIP/2.0/UDP s.a1.under.test.com;branch=z9hG4bK332b56.1;received=3ffe:501:ffff:100::30
From: <sip:UEa1_public_1@under.test.com>;tag=251170
To: <sip:UEa1_public_1@under.test.com>;tag=41415
Call-ID: c89rjhnedlrfjfsj40a222@under.test.com
CSeq: 1 NOTIFY
Content-Length: 0

[OBSERVABLE RESULTS]

*1: 11 REGISTER from NUT to P-CSCF

See generic_REGISTER

*2: 13 REGISTER for authentication from NUT to P-CSCF

See generic_Auth_REGISTER



*3: 15 SUBSCRIBE from NUT to P-CSCF

See generic_SUBSCRIBE

*4: 18 NOTIFY 200 OK from NUT to P-CSCF

See generic_200-NOTIFY

4.1.14 UE-RG-B-14-AKA - Reception of 504 response to reregistration

[NAME]

UE-RG-B-14-AKA - Reception of 504 response to reregistration

[TARGET]

IMS User Equipment (NUT)

[PURPOSE]

To verify that the UE properly perform the procedures for initial registration after received 504 (Server Time-Out) response.

[REFERENCE]

TS24.229 5.1.1.2.1

TS24.229 5.1.1.2.2

TS24.229 5.1.1.3

TS24.229 5.1.1.4.1

TS24.229 5.1.1.5.1

[REQUIREMENT]

NONE

[PARAMETER(NUT)]

public-user-id : sip:UEa1_public_1@under.test.com

private-user-id : UEa1_private@under.test.com

contact_URI : sip:UEa1_public_1@node.under.test.com

HOMENETWORK Domain : sip:under.test.com



[PARAMETER(TESTER)]

P-CSCFa1 : sip:p.a1.under.test.com
 S-CSCFa1 : sip:s.a1.under.test.com

[ADDRESS]

UEa1(NUT) : 3ffe:501:ffff:1000::1000
 Router(R1) : 3ffe:501:ffff:1000::1
 P-CSCFa1 : 3ffe:501:ffff:100::10
 I-CSCFa1 : 3ffe:501:ffff:100::20
 S-CSCFa1 : 3ffe:501:ffff:100::30
 DNS : 3ffe:501:ffff:100::40
 DHCP : 3ffe:501:ffff:100::50

[TOPOLOGY]

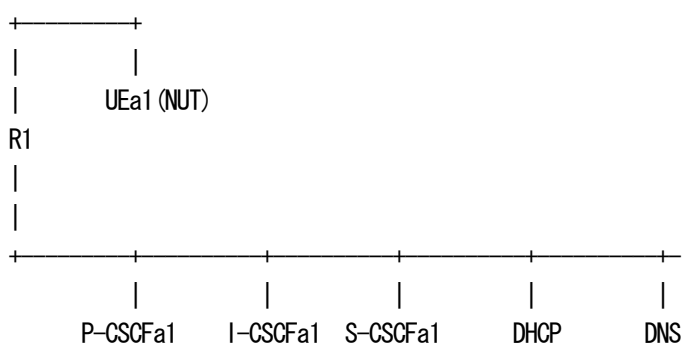

[INITIALIZATION]

Set up IP Address using A or B.

A. Router Advertisement

B. DHCPv6

(NUT)

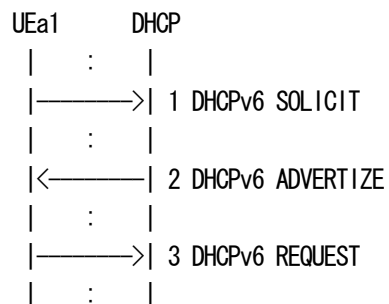



|<-----| 4 DHCPv6 REPLY
 | : |

[PROCEDURE]

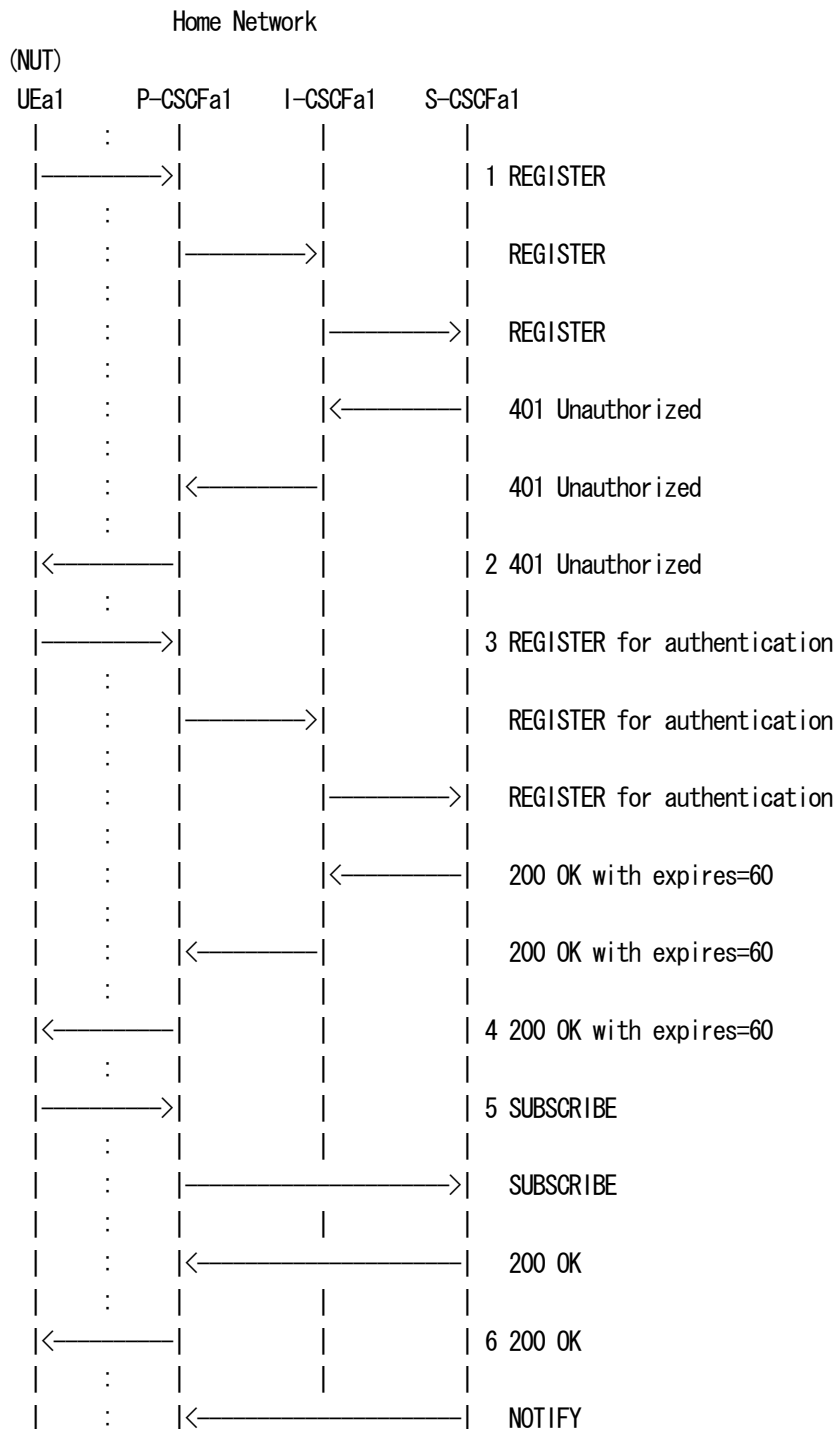

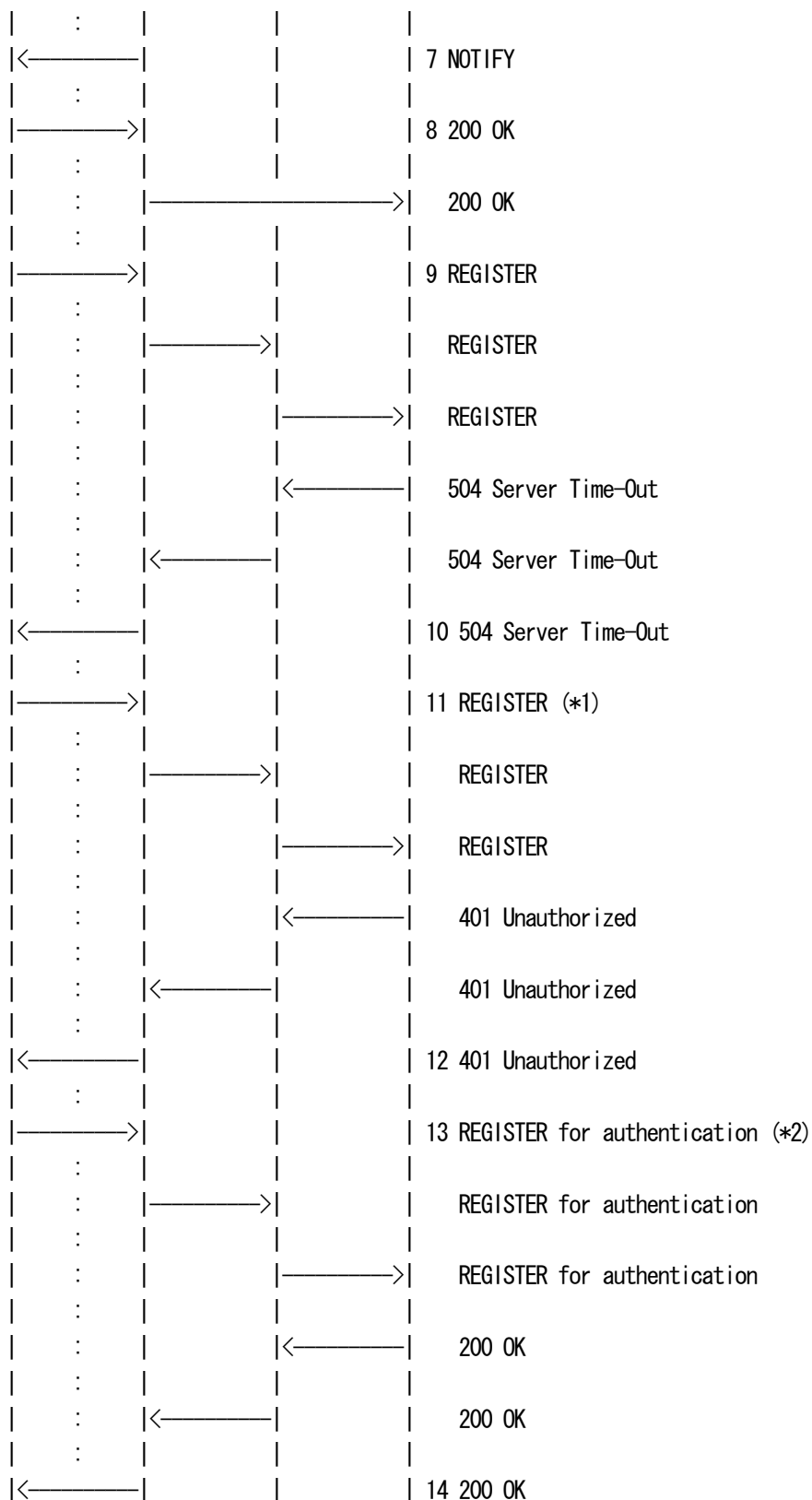

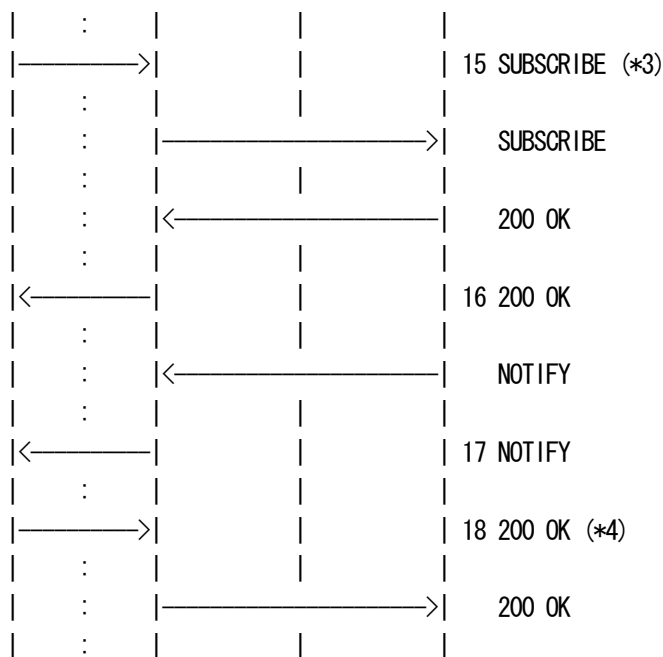

- 1 NUT sends REGISTER
- 2 NUT receives 401 Unauthorized
- 3 NUT sends REGISTER for authentication
- 4 NUT receives 200 OK
- 5 NUT sends SUBSCRIBE
- 6 NUT receives 200 OK
- 7 NUT receives NOTIFY
- 8 NUT sends 200 OK
- 9 NUT sends REGISTER
- 10 NUT receives 504 Server Time-Out
- 11 NUT sends REGISTER
- 12 NUT receives 401 Unauthorized
- 13 NUT sends REGISTER for authentication
- 14 NUT receives 200 OK
- 15 NUT sends SUBSCRIBE
- 16 NUT receives 200 OK
- 17 NUT receives NOTIFY
- 18 NUT sends 200 OK

=== Message example ===

As regards the message 1-9, please refer to the message 1-9 in UE-RG-B-2-AKA.

10. 504 Server Time-Out P-CSCF -> NUT

SIP/2.0 504 Server Time-Out

Via: SIP/2.0/UDP [3ffe:501:ffff:1000::1000]:1357;branch=z9hG4bKnashds9



From: <sip:UEa1_public_1@under.test.com>;tag=4fa4
To: <sip:UEa1_public_1@under.test.com>;tag=5ef6
Call-ID: apb03a0s09dkjdfglkj49111@under.test.com
CSeq: 3 REGISTER
Content-Length: 0

11. REGISTER NUT -> P-CSCF

REGISTER sip:under.test.com SIP/2.0
Via: SIP/2.0/UDP [3ffe:501:ffff:1000::1000]:1357;branch=z9hG4bKnashdt7
Max-Forwards: 70
From: <sip:UEa1_public_1@under.test.com>;tag=5fa3
To: <sip:UEa1_public_1@under.test.com>
Contact: <sip:UEa1_public_1@node.under.test.com:1357>;expires=600000
Call-ID: bpb03a0s09dkjdfglkj49111@under.test.com
Authorization: Digest username="UEa1_private@under.test.com", realm="under.test.com", nonce="", uri="sip:under.test.com", response=""
Security-Client: ipsec-3gpp; mode="trans"; alg=hmac-sha-1-96; spi-c=33456789; spi-s=22345678; port-c=3468; port-s=1357
Require: sec-agree
Proxy-Require: sec-agree
CSeq: 1 REGISTER
Supported: path
Content-Length: 0

12. 401 Unauthorized P-CSCF -> NUT

SIP/2.0 401 Unauthorized
Via: SIP/2.0/UDP [3ffe:501:ffff:1000::1000]:1357;branch=z9hG4bKnashdt7
WWW-Authenticate: Digest realm="under.test.com", nonce="J2U8vpY3qJhiuZNRke/ObponGSCcLm5iR+WCRkWyOm", algorithm=AKAv1-MD5
From: <sip:UEa1_public_1@under.test.com>;tag=5fa3
To: <sip:UEa1_public_1@under.test.com>;tag=6ef4
Call-ID: bpb03a0s09dkjdfglkj49111@under.test.com
Security-Server: ipsec-3gpp; alg=hmac-sha-1-96; spi-c=266; spi-s=267; port-c=10004; port-s=10001
CSeq: 1 REGISTER
Content-Length: 0

13. REGISTER NUT -> P-CSCF

REGISTER sip:under.test.com SIP/2.0
Via: SIP/2.0/UDP [3ffe:501:ffff:1000::1000]:1357;branch=z9hG4bKnashdt8
Max-Forwards: 70



From: <sip:UEa1_public_1@under.test.com>;tag=5fa3
To: <sip:UEa1_public_1@under.test.com>
Contact: <sip:UEa1_public_1@node.under.test.com:1357>;expires=600000
Call-ID: bpb03a0s09dkjdfglkj49111@under.test.com
Authorization: Digest username="UEa1_private@under.test.com", realm="under.test.com",
algorithm=AKAv1-MD5, nonce="J2U8vpY3qJhiuZNRke/ObponGSCcLm5iR+WCRkVYoM",
uri="sip:under.test.com", response="7729fae49393a05397450978507c4ef2"
Security-Client: ipsec-3gpp; mode="trans"; alg=hmac-sha-1-96; spi-c=33456789; spi-s=22345678;
port-c=3468; port-s=1357
Security-Verify: ipsec-3gpp; alg=hmac-sha-1-96; spi-c=266; spi-s=267; port-c=10004; port-s=10001
Require: sec-agree
Proxy-Require: sec-agree
CSeq: 2 REGISTER
Supported: path
Content-Length: 0

14. 200 OK P-CSCF -> NUT

SIP/2.0 200 OK
Via: SIP/2.0/UDP [3ffe:501:ffff:1000::1000]:1357;branch=z9hG4bKnashdt8
From: <sip:UEa1_public_1@under.test.com>;tag=5fa3
To: <sip:UEa1_public_1@under.test.com>;tag=6ef5
Call-ID: bpb03a0s09dkjdfglkj49111@under.test.com
Contact: <sip:UEa1_public_1@node.under.test.com:1357>;expires=600000
Path: <sip:term@p.a1.under.test.com;lr>
Service-Route: <sip:orig@s.a1.under.test.com;lr>
CSeq: 2 REGISTER
P-Associated-URI: <sip:UEa1_public_1@under.test.com>
Date: Wed, 11 July 2001 08:49:37 GMT
Content-Length: 0

15. SUBSCRIBE NUT -> P-CSCF

SUBSCRIBE sip:UEa1_public_1@under.test.com SIP/2.0
Via: SIP/2.0/UDP [3ffe:501:ffff:1000::1000]:1357;branch=z9hG4bKnashdsb1
Max-Forwards: 70
Route: <sip:p.a1.under.test.com:10001;lr>,<sip:orig@s.a1.under.test.com;lr>
From: <sip:UEa1_public_1@under.test.com>;tag=41415
To: <sip:UEa1_public_1@under.test.com>
Require: sec-agree
Proxy-Require: sec-agree
Call-ID: c89rjhnedlrfjfsj40a222@under.test.com
CSeq: 1 SUBSCRIBE



Allow-Events: reg
Event: reg
Security-Verify: ipsec-3gpp; alg=hmac-sha-1-96; spi-c=266; spi-s=267; port-c=10004; port-s=10001
Expires: 600000
Contact: <sip:UEa1_public_1@node.under.test.com:1357>
Content-Length: 0

16. 200 OK P-CSCF -> NUT
SIP/2.0 200 OK
Via: SIP/2.0/UDP [3ffe:501:ffff:1000::1000]:1357;branch=z9hG4bKnashdsb1
Record-Route: <sip:p.a1.under.test.com:10001;lr>
From: <sip:UEa1_public_1@under.test.com>;tag=41415
To: <sip:UEa1_public_1@under.test.com>;tag=251170
Call-ID: c89rjhnedlrffflsj40a222@under.test.com
CSeq: 1 SUBSCRIBE
Allow-Events: reg
Expires: 600000
Contact: <sip:s.a1.under.test.com>
Content-Length: 0

17. NOTIFY P-CSCF -> NUT
NOTIFY sip:UEa1_public_1@node.under.test.com:1357 SIP/2.0
Via: SIP/2.0/UDP p.a1.under.test.com:10001;branch=z9hG4bK240f82.1,
SIP/2.0/UDP s.a1.under.test.com;branch=z9hG4bK332b56.1;received=3ffe:501:ffff:100::30
Max-Forwards: 69
From: <sip:UEa1_public_1@under.test.com>;tag=251170
To: <sip:UEa1_public_1@under.test.com>;tag=41415
Call-ID: c89rjhnedlrffflsj40a222@under.test.com
CSeq: 1 NOTIFY
Contact: <sip:s.a1.under.test.com>
Subscription-State: active;expires=600000
Event: reg
Content-Type: application/reginfo+xml
Content-Length: (...)

```
<?xml version="1.0"?>
<reginfo xmlns="urn:ietf:params:xml:ns:reginfo" version="0" state="full">
  <registration aor="sip:UEa1_public_1@under.test.com" id="a7" state="active">
    <contact id="76" state="active" event="registered">
      <uri>sip:UEa1_public_1@node.under.test.com</uri>
    </contact>
  </registration>
</reginfo>
```



</registration>
</reginfo>

18. 200 OK NUT -> P-CSCF

SIP/2.0 200 OK

Via: SIP/2.0/UDP p.a1.under.test.com:10001;branch=z9hG4bK240f82.1;received=3ffe:501:ffff:100::10,

SIP/2.0/UDP s.a1.under.test.com;branch=z9hG4bK332b56.1;received=3ffe:501:ffff:100::30

From: <sip:UEa1_public_1@under.test.com>;tag=251170

To: <sip:UEa1_public_1@under.test.com>;tag=41415

Call-ID: c89rjhnedlrfjfsj40a222@under.test.com

CSeq: 1 NOTIFY

Content-Length: 0

[OBSERVABLE RESULTS]

*1: 11 REGISTER from NUT to P-CSCF

See generic_REGISTER

*2: 13 REGISTER for authentication from NUT to P-CSCF

See generic_Auth_REGISTER

*3: 15 SUBSCRIBE from NUT to P-CSCF

See generic_SUBSCRIBE

*4: 18 NOTIFY 200 OK from NUT to P-CSCF

See generic_200-NOTIFY

4.1.15 UE-RG-B-15-AKA - Timer F expiration (Registration)

[NAME]

UE-RG-B-15-AKA - Timer F expiration (Registration)

[TARGET]

IMS User Equipment (NUT)



[PURPOSE]

To verify that the UEa1 properly stops processing of all ongoing dialogs and transactions and silently discards them locally when the timer F expires at the UE.

[REFERENCE]

TS24.229 5.1.1.4.1

[REQUIREMENT]

NONE

[PARAMETER(NUT)]

public-user-id : sip:UEa1_public_1@under.test.com
private-user-id : UEa1_private@under.test.com
contact_URI : sip:UEa1_public_1@node.under.test.com
HOMENETWORK Domain : sip:under.test.com

[PARAMETER(TESTER)]

public-URI(UEa2) : sip:UEa2_public_1@under.test.com
P-CSCFa1 : sip:p.a1.under.test.com
S-CSCFa1 : sip:s.a1.under.test.com

[ADDRESS]

UEa1(NUT) : 3ffe:501:fff:1000::1000
UEa2 : 3ffe:501:fff:2000::1000
Router(R1) : 3ffe:501:fff:1000::1
P-CSCFa1 : 3ffe:501:fff:100::10
I-CSCFa1 : 3ffe:501:fff:100::20
S-CSCFa1 : 3ffe:501:fff:100::30
P-CSCFa2 : 3ffe:501:fff:200::10
I-CSCFa2 : 3ffe:501:fff:200::20
S-CSCFa2 : 3ffe:501:fff:200::30
DNS : 3ffe:501:fff:100::40
DHCP : 3ffe:501:fff:100::50

[TOPOLOGY]

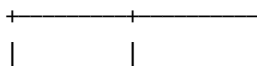

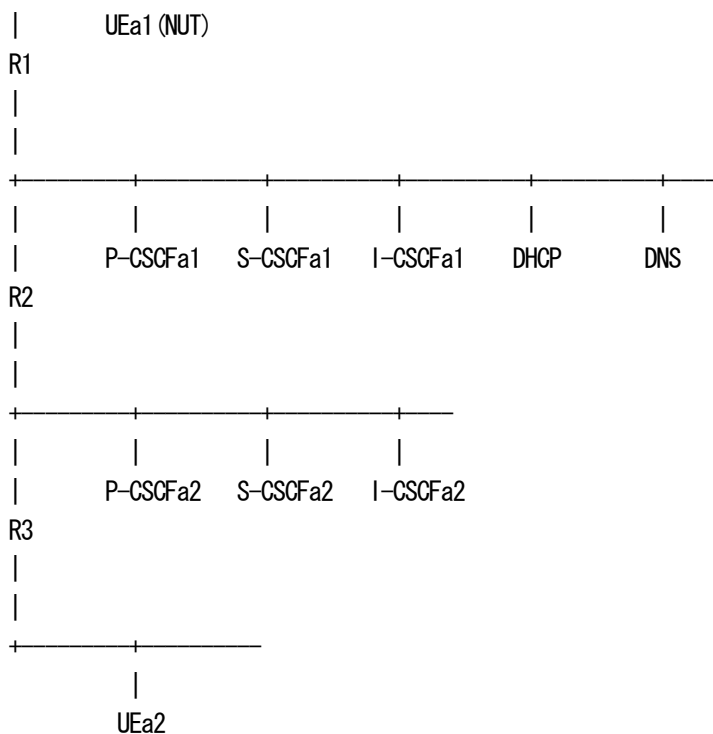

[INITIALIZATION]

Set up IP Address using A or B.

A. Router Advertisement

B. DHCPv6

(NUT)

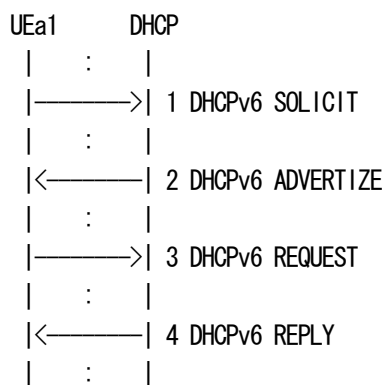

[PROCEDURE]

Home Network

(NUT)



UEa1	P-CSCFa1	S-CSCFa1	I-CSCFa1	I-CSCFa2	S-CSCFa2	P-CSCFa2	UEa2
	:						
	→						1 REGISTER
	:						
	:		→				REGISTER
	:						
	:		←				REGISTER
	:						
	:		→				401 Unauthorized
	:						
	:		←				401 Unauthorized
	:						
	←						2 401 Unauthorized
	:						
	→						3 REGISTER
	:						for authentication
	:		→				REGISTER
	:						for authentication
	:		←				REGISTER
	:						for authentication
	:		→				200 OK
	:						
	:		←				200 OK
	:						
	←						4 200 OK
	:						
	→						5 SUBSCRIBE
	:						
	:		→				SUBSCRIBE
	:						
	:		←				200 OK
	:						
	←						6 200 OK
	:						
	:		←				NOTIFY
	:						
	←						7 NOTIFY
	:						
	→						8 200 OK
	:						
	:		→				200 OK
	:						
	→						9 INVITE

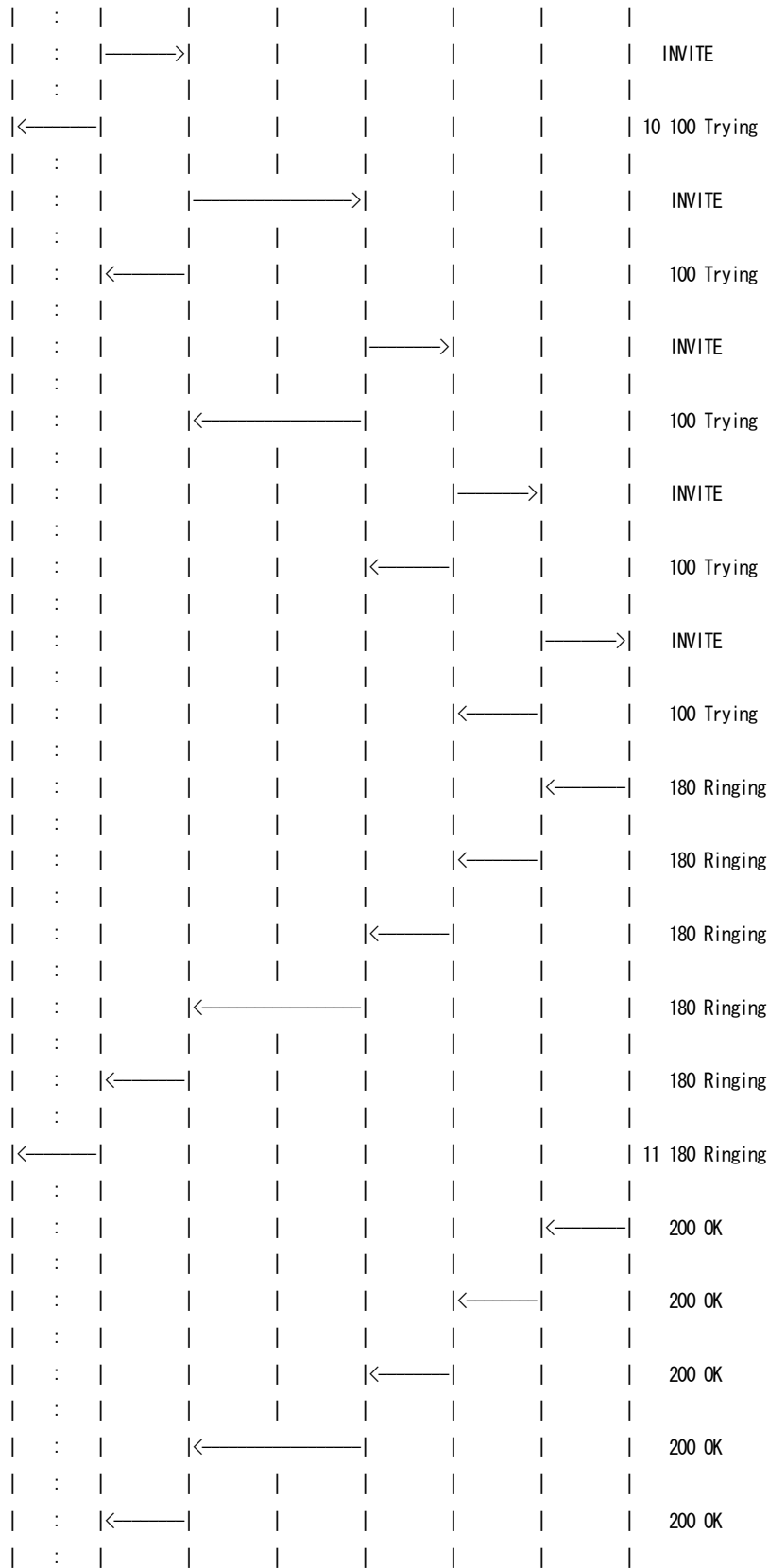

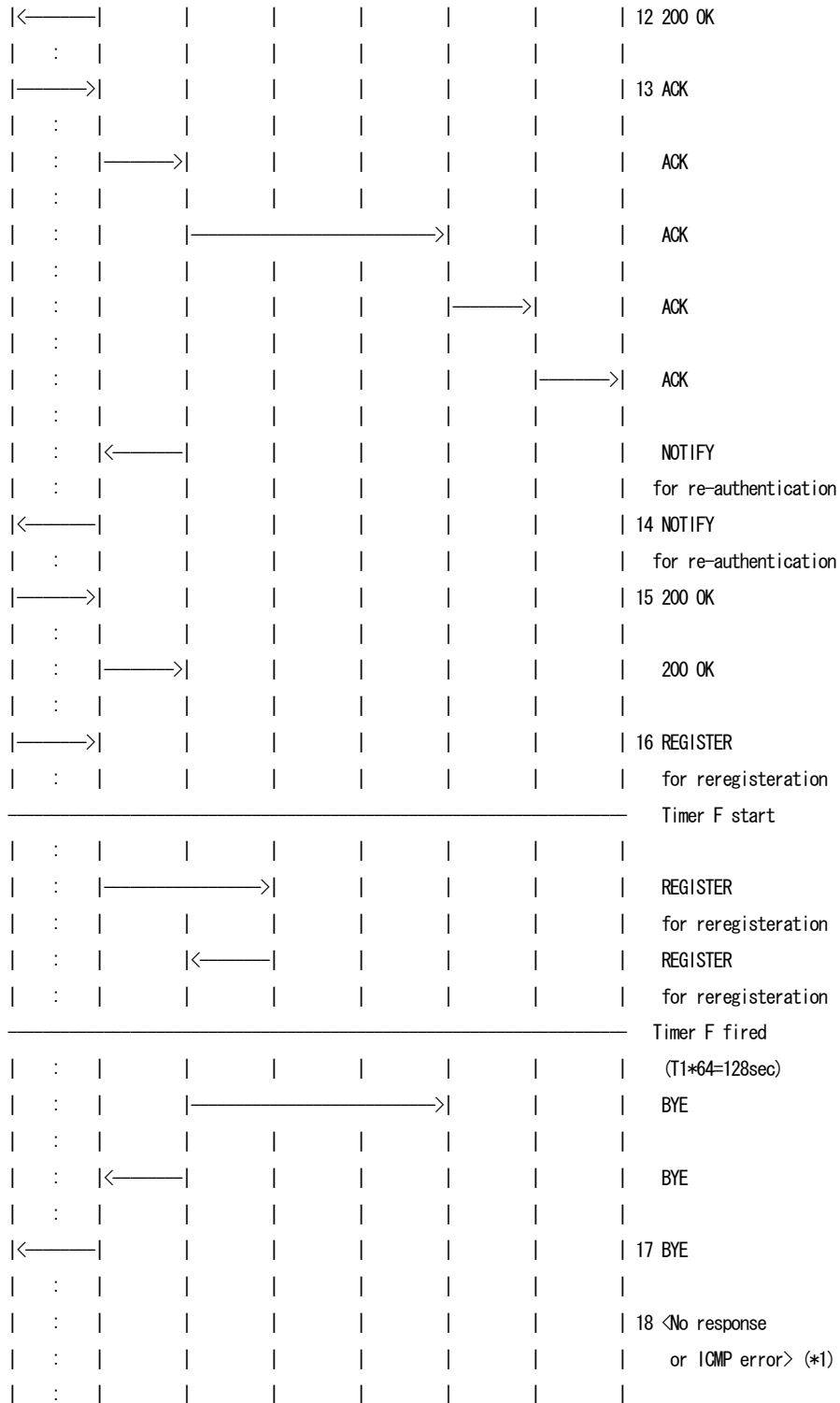

- 1 NUT sends REGISTER
- 2 NUT receives 401 Unauthorized
- 3 NUT sends REGISTER for authentication



- 4 NUT receives 200 OK
- 5 NUT sends SUBSCRIBE
- 6 NUT receives 200 OK
- 7 NUT receives NOTIFY
- 8 NUT sends 200 OK
- 9 NUT sends INVITE
- 10 NUT receives 100 Trying
- 11 NUT receives 180 Ringing
- 12 NUT receives 200 OK
- 13 NUT sends ACK
- 14 NUT receives NOTIFY for re-authentication
- 15 NUT sends 200 OK
- 16 NUT sends REGISTER for reregistration
- 17 Tester sends BYE
- 18 <No response or ICMP error>

=== Message example ===

As regards the message 1-8, please refer to the message 1-8 in UE-RG-B-1-AKA.
As regards the message 9-13, please refer to the message 1-5 in UE-SE-B-1-AKA.

14. NOTIFY P-CSCF -> NUT

NOTIFY sip:UEa1_public_1@node.under.test.com:1357 SIP/2.0
Via: SIP/2.0/UDP p.a1.under.test.com:10001;branch=z9hG4bK240f34.2,
SIP/2.0/UDP s.a1.under.test.com;branch=z9hG4bK332b23.2;received=3ffe:501:fff:100::30
Max-Forwards: 69
From: <sip:UEa1_public_1@under.test.com>;tag=151170
To: <sip:UEa1_public_1@under.test.com>;tag=31415
Call-ID: b89rjhnedlrfjflsj40a222@under.test.com
CSeq: 2 NOTIFY
Contact: <sip:s.a1.under.test.com>
Subscription-State: active;expires=600000
Event: reg
Content-Type: application/reginfo+xml
Content-Length: (...)

```
<?xml version="1.0"?>
<reginfo xmlns="urn:ietf:params:xml:ns:reginfo" version="1" state="full">
  <registration aor="sip:UEa1_public_1@under.test.com" id="a7" state="active">
    <contact id="76" state="active" event="shortened" expires="30">
      <uri>sip:UEa1_public_1@node.under.test.com</uri>
    </contact>
  </registration>
</reginfo>
```



15. 200 OK NUT -> P-CSCF

SIP/2.0 200 OK

Via: SIP/2.0/UDP p.a1.under.test.com:10001;branch=z9hG4bK240f34.2;
received=3ffe:501:ffff:100::10,SIP/2.0/UDP s.a1.under.test.com;branch=z9hG4bK332b23.2;
received=3ffe:501:ffff:100::30

From: <sip:UEa1_public_1@under.test.com>;tag=151170

To: <sip:UEa1_public_1@under.test.com>;tag=31415

Call-ID: b89rjhnedlrjflslj40a222@under.test.com

CSeq: 2 NOTIFY

Content-Length: 0

16. REGISTER NUT -> P-CSCF

REGISTER sip:under.test.com SIP/2.0

Via: SIP/2.0/UDP [3ffe:501:ffff:1000::1000]:1357;branch=z9hG4bKnashds9

Max-Forwards: 70

From: <sip:UEa1_public_1@under.test.com>;tag=4fa4

To: <sip:UEa1_public_1@under.test.com>

Contact: <sip:UEa1_public_1@node.under.test.com:1357>;expires=600000

Call-ID: apb03a0s09dkjdfglkj49111@under.test.com

Authorization: Digest username="UEa1_private@under.test.com", realm="under.test.com",
nonce="11U8vpY3qJhiuZNRke/NaponGSCdLm5iR+WCRkWYoM", uri="sip:under.test.com",
response="6629fae49393a05397450978507c4ef1"

Security-Client: ipsec-3gpp; mode="trans"; alg=hmac-sha-1-96; spi-c=33456789; spi-s=22345678;
port-c=3468; port-s=1357

Security-Verify: ipsec-3gpp; alg=hmac-sha-1-96; spi-c=256; spi-s=257; port-c=10002; port-s=10001

Require: sec-agree

Proxy-Require: sec-agree

CSeq: 3 REGISTER

Supported: path

Content-Length: 0

17. BYE P-CSCF -> NUT

BYE sip:UEa1_public_1@node.under.test.com:1357 SIP/2.0

Via: SIP/2.0/UDP p.a1.under.test.com:10001;branch=z9hG4bK431e418c501,
SIP/2.0/UDP s.a1.under.test.com;branch=z9hG4bKnashdsa2.3;received=3ffe:501:ffff:100::30,
SIP/2.0/UDP s.a2.under.test.com;branch=z9hG4bK721e418c9.1;received=3ffe:501:ffff:200::30,
SIP/2.0/UDP p.a2.under.test.com;branch=z9hG4bKnaghds30;received=3ffe:501:ffff:200::10,
SIP/2.0/UDP [3ffe:501:ffff:2000::1000]:22222;branch=z9hG4bKnashdsb3

Max-Forwards: 66



From: <sip:UEa2_public_1@under.test.com>;tag=314259
To: <sip:UEa1_public_1@under.test.com>;tag=9fxced76sl
Call-ID: 3848276298220188511@under.test.com
CSeq: 2 BYE
Content-Length: 0

18. <No response or ICMP error>

[OBSERVABLE RESULTS]

*1: 18 No response or ICMP error

The process of all ongoing dialogs and transactions SHALL be stopped and silently discarded them locally.[TS24229-5.1-177]

The UAC SHOULD NOT immediately re-attempt a registration to the same registrar.[RFC3261-10.2-18]

4.1.16 UE-RG-B-16-AKA - Reception of 401 response with no Security-Server header to initial registration

[NAME]

UE-RG-B-16-AKA - Reception of 401 response with no Security-Sever header to initial registration

[TARGET]

IMS User Equipment (NUT)

[PURPOSE]

To verify that the UEa1 properly abandons the authentication procedure and sends a new REGISTER request with a new Call-ID when Security-Sever header is not present.

[REFERENCE]

TS24.229 5.1.1.2.1

TS24.229 5.1.1.2.2

TS24.229 5.1.1.5.1



[REQUIREMENT]

NONE

[PARAMETER(NUT)]

public-user-id : sip:UEa1_public_1@under.test.com
private-user-id : UEa1_private@under.test.com
contact_URI : sip:UEa1_public_1@node.under.test.com
HOMENETWORK Domain : sip:under.test.com

[PARAMETER(TESTER)]

P-CSCFa1 : sip:p.a1.under.test.com
S-CSCFa1 : sip:s.a1.under.test.com

[ADDRESS]

UEa1(NUT) : 3fe:501:fff:1000::1000
Router(R1) : 3fe:501:fff:1000::1
P-CSCFa1 : 3fe:501:fff:100::10
I-CSCFa1 : 3fe:501:fff:100::20
S-CSCFa1 : 3fe:501:fff:100::30
DNS : 3fe:501:fff:100::40
DHCP : 3fe:501:fff:100::50

[TOPOLOGY]

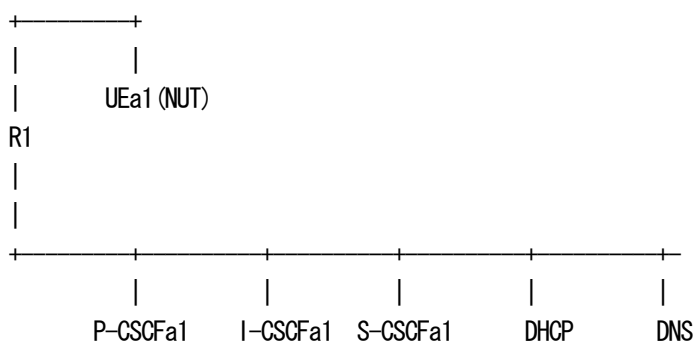

[INITIALIZATION]

Set up IP Address using A or B.

A. Router Advertisement

B. DHCPv6

(NUT)

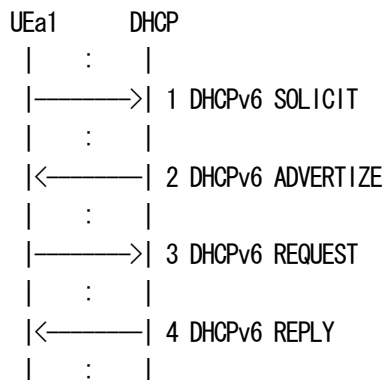

[PROCEDURE]

Home Network

(NUT)

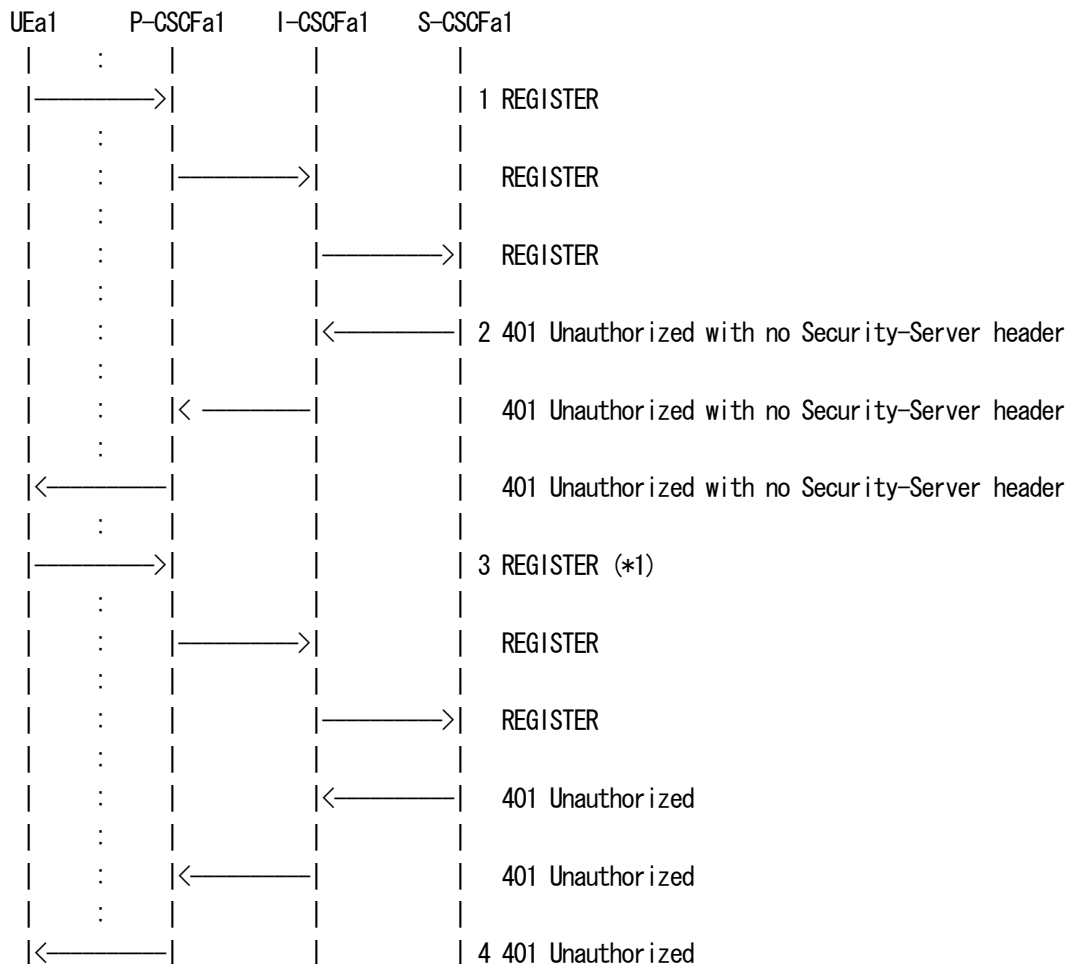

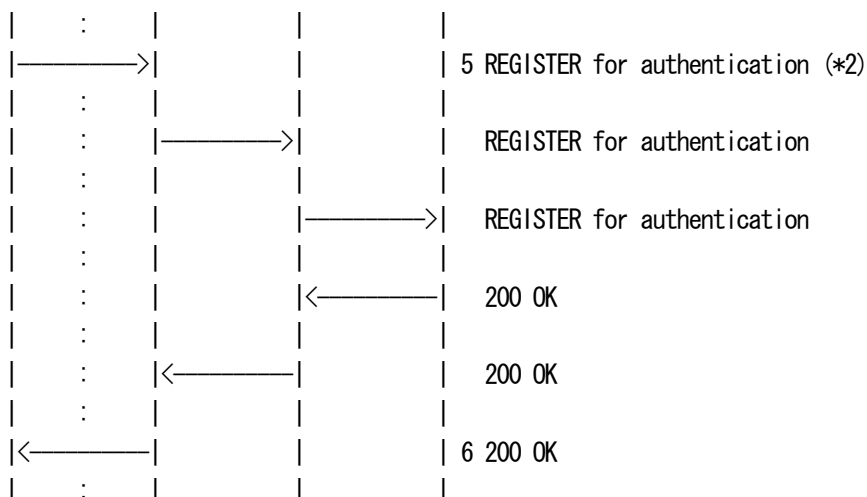

- 1 NUT sends REGISTER
- 2 NUT receives 401 Unauthorized with no Security-Server header
- 3 NUT sends REGISTER
- 4 NUT receives 401 Unauthorized
- 5 NUT sends REGISTER for authentication
- 6 NUT receives 200 OK

=== Message example ===

1. REGISTER NUT -> P-CSCF

```
REGISTER sip:under.test.com SIP/2.0
Via: SIP/2.0/UDP [3ffe:501:ffff:1000::1000]:5060;branch=z9hG4bKnashds7
Max-Forwards: 70
From: <sip:UEa1_public_1@under.test.com>;tag=4fa3
To: <sip:UEa1_public_1@under.test.com>
Contact: <sip:UEa1_public_1@node.under.test.com>;expires=600000
Call-ID: apb03a0s09dkjdfglkj49111@under.test.com
Authorization: Digest username="UEa1_private@under.test.com", realm="under.test.com", nonce="",
uri="sip:under.test.com", response=""
Security-Client: ipsec-3gpp; mode="trans"; alg=hmac-sha-1-96; spi-c=23456789; spi-s=12345678;
port-c=2468; port-s=1357
Require: sec-agree
Proxy-Require: sec-agree
CSeq: 1 REGISTER
Supported: path
Content-Length: 0
```

2. 401 Unauthorized P-CSCF -> NUT



SIP/2.0 401 Unauthorized

Via: SIP/2.0/UDP [3ffe:501:ffff:1000::1000]:5060;branch=z9hG4bKnashds7
WWW-Authenticate: Digest realm="under.test.com",
nonce="11U8vpY3qJhiuZNRke/NaponGSCcLm5iR+WCRkWYoM", algorithm=AKAv1-MD5
From: <sip:UEa1_public_1@under.test.com>;tag=4fa3
To: <sip:UEa1_public_1@under.test.com>;tag=5ef4
Call-ID: apb03a0s09dkjdfglkj49111@under.test.com
CSeq: 1 REGISTER
Content-Length: 0

3. REGISTER NUT -> P-CSCF

REGISTER sip:under.test.com SIP/2.0
Via: SIP/2.0/UDP [3ffe:501:ffff:1000::1000]:5060;branch=z9hG4bKnashdt7
Max-Forwards: 70
From: <sip:UEa1_public_1@under.test.com>;tag=5fa3
To: <sip:UEa1_public_1@under.test.com>
Contact: <sip:UEa1_public_1@node.under.test.com>;expires=600000
Call-ID: bpb03a0s09dkjdfglkj49111@under.test.com
Authorization: Digest username="UEa1_private@under.test.com", realm="under.test.com", nonce="",
uri="sip:under.test.com", response=""
Security-Client: ipsec-3gpp; mode="trans"; alg=hmac-sha-1-96; spi-c=23456780; spi-s=12345679;
port-c=2469; port-s=1357
Require: sec-agree
Proxy-Require: sec-agree
CSeq: 1 REGISTER
Supported: path
Content-Length: 0

4. 401 Unauthorized P-CSCF -> NUT

SIP/2.0 401 Unauthorized
Via: SIP/2.0/UDP [3ffe:501:ffff:1000::1000]:5060;branch=z9hG4bKnashdt7
WWW-Authenticate: Digest realm="under.test.com",
nonce="J2U8vpY3qJhiuZNRke/ObponGSCcLm5iR+WCRkWYoM", algorithm=AKAv1-MD5
From: <sip:UEa1_public_1@under.test.com>;tag=5fa3
To: <sip:UEa1_public_1@under.test.com>;tag=6ef4
Call-ID: bpb03a0s09dkjdfglkj49111@under.test.com
Security-Server: ipsec-3gpp; alg=hmac-sha-1-96; spi-c=256; spi-s=257; port-c=10002; port-s=10001
CSeq: 1 REGISTER
Content-Length: 0



5. REGISTER NUT -> P-CSCF

REGISTER sip:under.test.com SIP/2.0
Via: SIP/2.0/UDP [3ffe:501:ffff:1000::1000]:1357;branch=z9hG4bKnashdt8
Max-Forwards: 70
From: <sip:UEa1_public_1@under.test.com>;tag=5fa3
To: <sip:UEa1_public_1@under.test.com>
Contact: <sip:UEa1_public_1@node.under.test.com:1357>;expires=600000
Call-ID: bpb03a0s09dkjdfglkj49111@under.test.com
Authorization: Digest username="UEa1_private@under.test.com", realm="under.test.com",
algorithm=AKAv1-MD5, nonce="J2U8vpY3qJhiuZnrke/ObponGSCcLm5iR+WCRkWYoM",
uri="sip:under.test.com", response="6629fae49393a05397450978507c4ef1"
Security-Client: ipsec-3gpp; mode="trans"; alg=hmac-sha-1-96; spi-c=23456780; spi-s=12345679;
port-c=2469; port-s=1357
Security-Verify: ipsec-3gpp; alg=hmac-sha-1-96; spi-c=256; spi-s=257; port-c=10002; port-s=10001
Require: sec-agree
Proxy-Require: sec-agree
CSeq: 2 REGISTER
Supported: path
Content-Length: 0

6. 200 OK P-CSCF -> NUT

SIP/2.0 200 OK
Via: SIP/2.0/UDP [3ffe:501:ffff:1000::1000]:1357;branch=z9hG4bKnashdt8
From: <sip:UEa1_public_1@under.test.com>;tag=5fa3
To: <sip:UEa1_public_1@under.test.com>;tag=6ef5
Call-ID: bpb03a0s09dkjdfglkj49111@under.test.com
Contact: <sip:UEa1_public_1@node.under.test.com:1357>;expires=600000
Path: <sip:term@p.a1.under.test.com;lr>
Service-Route: <sip:orig@s.a1.under.test.com;lr>
CSeq: 2 REGISTER
P-Associated-URI: <sip:UEa1_public_1@under.test.com>
Date: Wed, 11 July 2001 08:49:37 GMT
Content-Length: 0

[OBSERVABLE RESULTS]

*1: 3 REGISTER from NUT to P-CSCF

See generic_REGISTER

Authentication procedure SHALL be abandoned and a new REGISTER request
SHALL be sent with a new Call-ID if the Security-Server header field is



not present or it does not contain the parameters required for the setup of the set of security associations.[TS24229-5.1-219]

*2: 5 REGISTER for authentication from NUT to P-CSCF

See generic_Auth_REGISTER

4.1.17 UE-RG-B-17-AKA - Charge from the old SAs to the new SAs

[NAME]

UE-RG-B-17-AKA - Change from the old SAs to the new SAs

[TARGET]

IMS User Equipment (NUT)

[PURPOSE]

To verify that the UEa1 properly deletes the old set of security associations and related keys it may have with the P-CSCF after all SIP transactions that use the old set of security associations are completed if the first request or response protected with the newly established set of security associations is received from the P-CSCF.

[REFERENCE]

TS24.229 5.1.1.5.1

[REQUIREMENT]

NONE

[PARAMETER(NUT)]

public-user-id : sip:UEa1_public_1@under.test.com
private-user-id : UEa1_private@under.test.com
contact_URI : sip:UEa1_public_1@node.under.test.com
HOMENETWORK Domain : sip:under.test.com

[PARAMETER(TESTER)]

public-URI(UEa2) : sip:UEa2_public_1@under.test.com



P-CSCFa1 : sip:p.a1.under.test.com
S-CSCFa1 : sip:s.a1.under.test.com

[ADDRESS]

UEa1(NUT) : 3ffe:501:fff:1000::1000
UEa2 : 3ffe:501:fff:2000::1000
P-CSCFa1 : 3ffe:501:fff:100::10
I-CSCFa1 : 3ffe:501:fff:100::20
S-CSCFa1 : 3ffe:501:fff:100::30
P-CSCFa2 : 3ffe:501:fff:200::10
I-CSCFa2 : 3ffe:501:fff:200::20
S-CSCFa2 : 3ffe:501:fff:200::30
Router(R1) : 3ffe:501:fff:1000::1
DNS : 3ffe:501:fff:100::40
DHCP : 3ffe:501:fff:100::50

[TOPOLOGY]

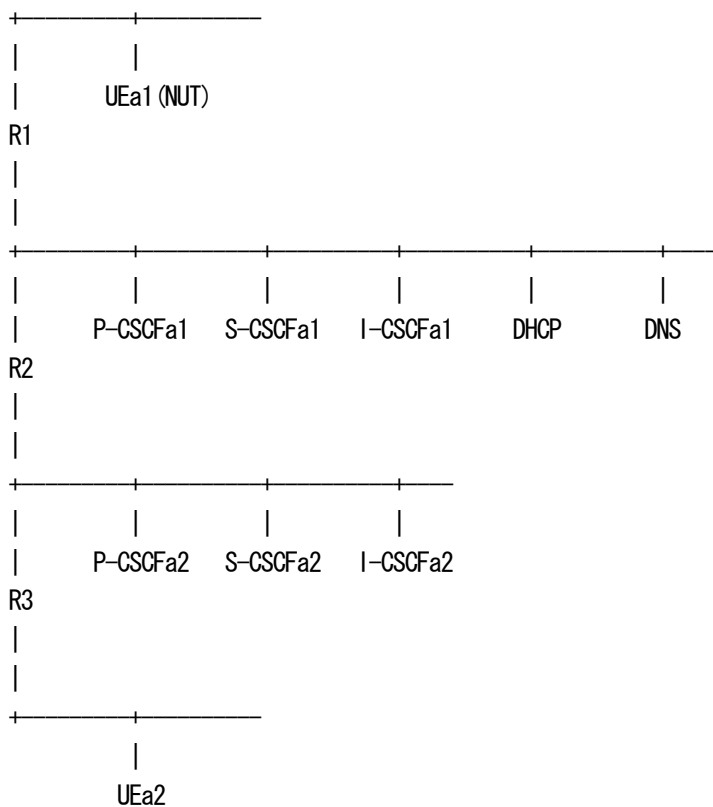

[INITIALIZATION]



Set up IP Address using A or B.

A. Router Advertisement

B. DHCPv6

(NUT)

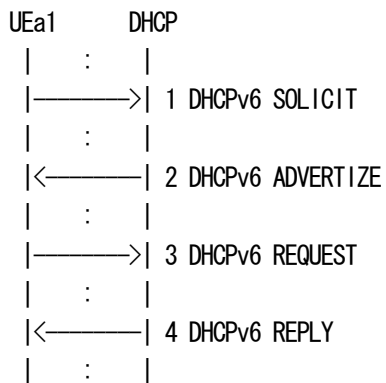

[PROCEDURE]

Home Network

(NUT)

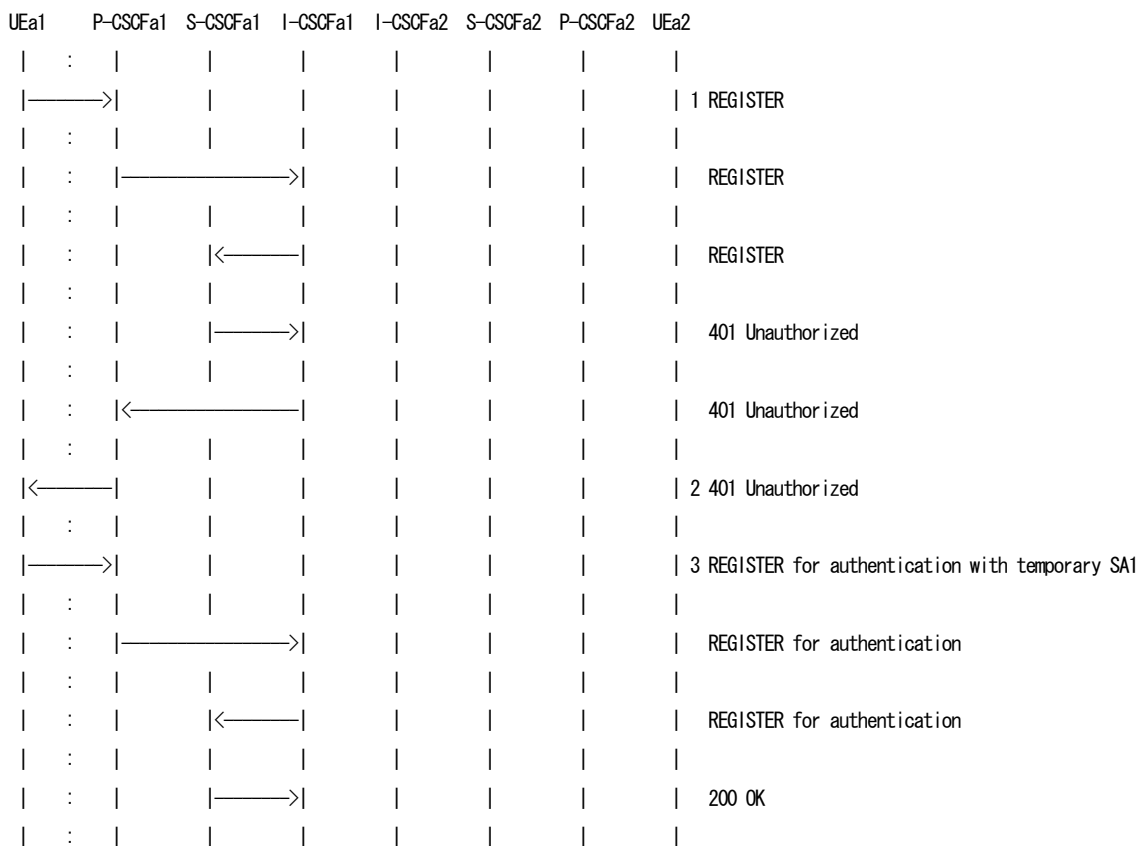

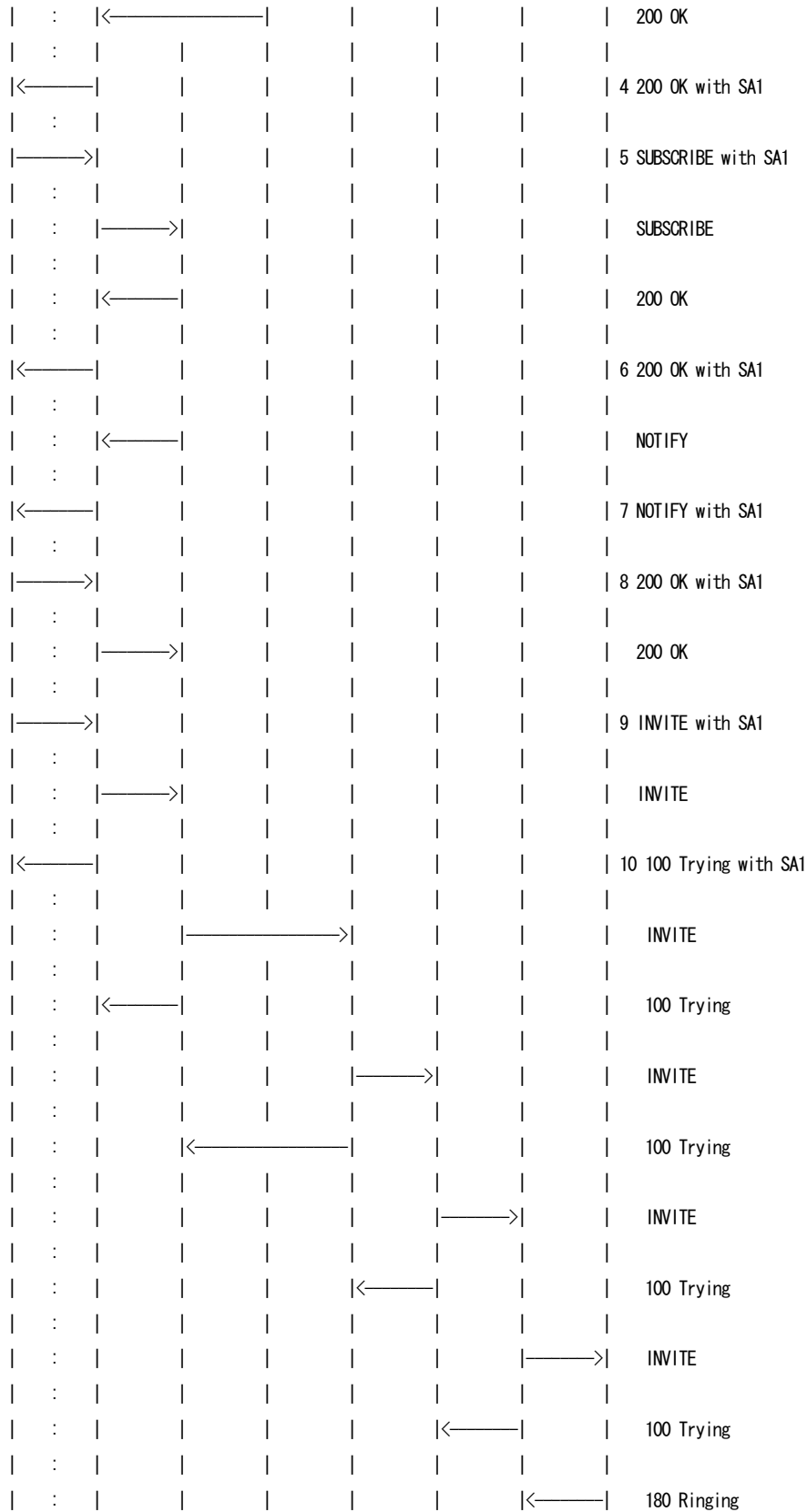



:						
:				<---		180 Ringing
:						
:				<---		180 Ringing
:						
:		<---				180 Ringing
:						
:	<---					180 Ringing
:						
<---						11 180 Ringing with SA1
:						
:	<---					NOTIFY for re-authentication
:						
<---						12 NOTIFY for re-authentication with SA1
:						
---->						13 200 OK with SA1
:						
:	---->					200 OK
:						
---->						14 REGISTER for re-authentication with SA1
:						
:	----->					REGISTER for re-authentication
:						
:	<---					REGISTER for re-authentication
:						
:	---->					401 Unauthorized
:						
:	<---					401 Unauthorized
:						
<---						15 401 Unauthorized with SA1
:						
---->						16 REGISTER for authentication with temporary SA2
:						
:	----->					REGISTER for authentication
:						
:	<---					REGISTER for authentication
:						
:	---->					200 OK
:						
:	<---					200 OK
:						
<---						17 200 OK with SA1
:						

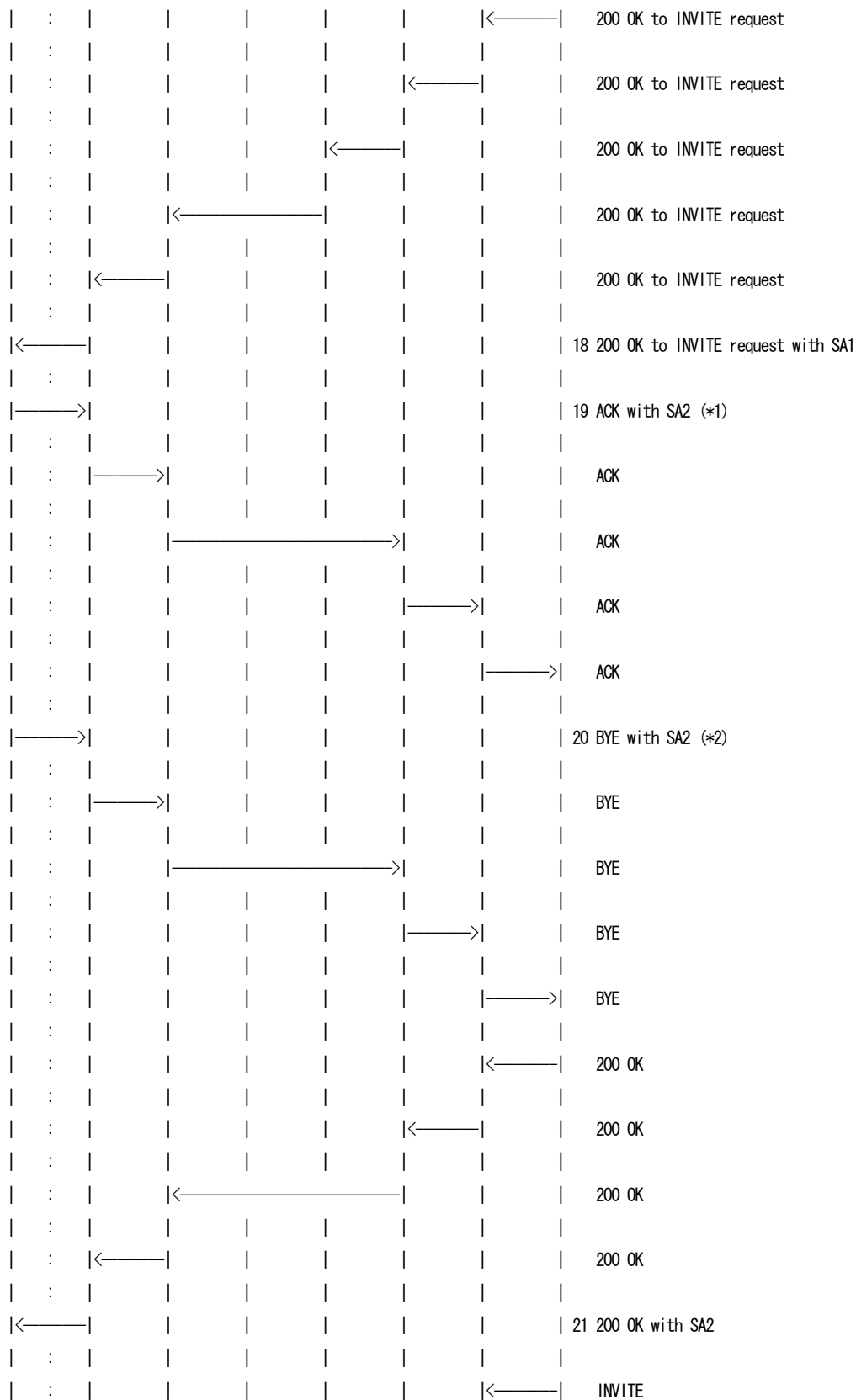

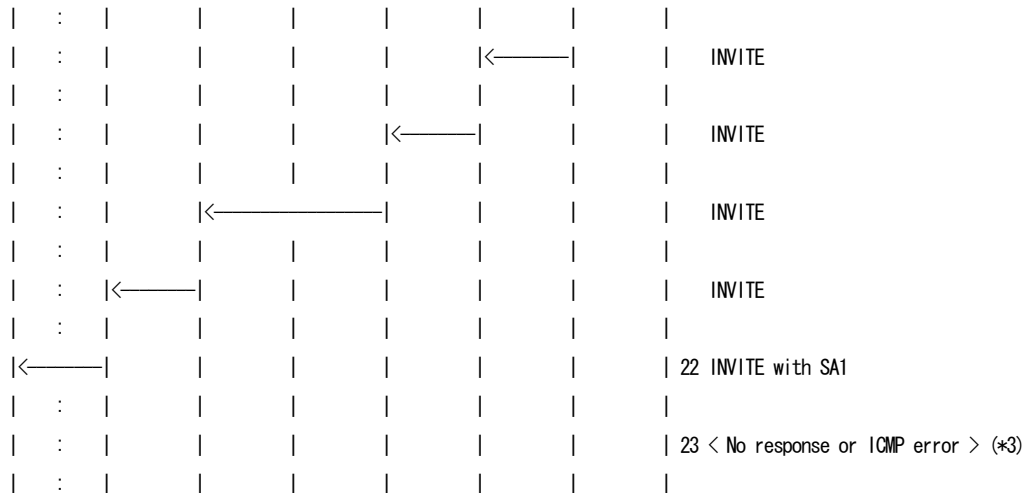

- 1 NUT sends REGISTER
- 2 NUT receives 401 Unauthorized
- 3 NUT sends REGISTER for authentication with temporary SA1
- 4 NUT receives 200 OK with SA1
- 5 NUT sends SUBSCRIBE with SA1
- 6 NUT receives 200 OK with SA1
- 7 NUT receives NOTIFY with SA1
- 8 NUT sends 200 OK with SA1
- 9 NUT sends INVITE with SA1
- 10 NUT receives 100 Trying with SA1
- 11 NUT receives 180 Ringing with SA1
- 12 NUT receives NOTIFY for re-authentication with SA1
- 13 NUT sends 200 OK to NOTIFY with SA1
- 14 NUT sends REGISTER for re-authentication with SA1
- 15 NUT receives 401 Unauthorized with SA1
- 16 NUT sends REGISTER for authentication with temporary SA2
- 17 NUT receives 200 OK to REGISTER with SA2
- 18 NUT receives 200 OK to INVITE request with SA1
- 19 NUT sends ACK with SA2
- 20 NUT sends BYE with SA2
- 21 NUT receives 200 OK
- 22 Tester sends INVITE with SA1
- 23 < No response or ICMP error >

=== Message example ===

As regards the message 1-8, please refer to the message 1-8 in UE-RG-B-1-AKA.
 As regards the message 9-11, please refer to the message 1-3 in UE-SE-B-1-AKA.
 As regards the message 12-17, please refer to the message 9-14 in UE-RG-B-3-AKA.



18. 200 OK P-CSCF -> NUT

SIP/2.0 200 OK

Via: SIP/2.0/UDP [3ffe:501:ffff:1000::1000]:1357;branch=z9hG4bK74bf9

Record-Route: <sip:p.a2.under.test.com;lr>,<sip:s.a2.under.test.com;lr>,<sip:s.a1.under.test.com;lr>,<sip:p.a1.under.test.com:10001;lr>

From: <sip:UEa1_public_1@under.test.com>;tag=9fxced76sl

To: <sip:UEa2_public_1@under.test.com>;tag=314259

Call-ID: 3848276298220188511@under.test.com

Call-ID: 3848276298220188511@under.test.com

CSeq: 1 INVITE

Contact: <sip:UEa2_public_1@nodea2.under.test.com:22222>

Supported:

Allow: INVITE,ACK,CANCEL,OPTIONS,BYE

Allow-Events: reg

Content-Type: application/sdp

Content-Length: 153

v=0

o=UEa2 2890844527 2890844527 IN IP6 nodea2.under.test.com

s=-

c=IN IP6 nodea2.under.test.com

t=0 0

m=audio 3456 RTP/AVP 0

b=AS:75

a=rtpmap:0 PCMU/8000

19. ACK NUT -> P-CSCF

ACK sip:UEa2_public_1@nodea2.under.test.com:22222 SIP/2.0

Via: SIP/2.0/UDP [3ffe:501:ffff:1000::1000]:1357;branch=z9hG4bK74bf10

Route: <sip:p.a1.under.test.com:10001;lr>,<sip:s.a1.under.test.com;lr>,<sip:s.a2.under.test.com;lr>,<sip:p.a2.under.test.com;lr>

Route: <sip:p.a1.under.test.com:10001;lr>,<sip:s.a1.under.test.com;lr>,<sip:s.a2.under.test.com;lr>,<sip:p.a2.under.test.com;lr>

Max-Forwards: 70

From: <sip:UEa1_public_1@under.test.com>;tag=9fxced76sl

To: <sip:UEa2_public_1@under.test.com>;tag=314259

Call-ID: 3848276298220188511@under.test.com

CSeq: 1 ACK

Content-Length: 0

20. BYE NUT -> P-CSCF

BYE sip:UEa2_public_1@nodea2.under.test.com:22222 SIP/2.0

Via: SIP/2.0/UDP [3ffe:501:ffff:1000::1000]:1357;branch=z9hG4bK74bf11

Route: <sip:p.a1.under.test.com:10001;lr>,<sip:s.a1.under.test.com;lr>,<sip:s.a2.under.test.com;lr>,<sip:p.a2.under.test.com;lr>



<sip:s.a2.under.test.com;lr>,<sip:p.a2.under.test.com;lr>
Max-Forwards: 70
From: <sip:UEa1_public_1@under.test.com>;tag=9fxced76sl
To: <sip:UEa2_public_1@under.test.com>;tag=314259
Call-ID: 3848276298220188511@under.test.com
CSeq: 2 BYE
Security-Verify: ipsec-3gpp; alg=hmac-sha-1-96; spi-c=266; spi-s=267; port-c=10004; port-s=10001
Require: sec-agree
Proxy-Require: sec-agree
Content-Length: 0

21. 200 OK P-CSCF -> NUT

SIP/2.0 200 OK
Via: SIP/2.0/UDP [3ffe:501:ffff:1000::1000]:1357;branch=z9hG4bK74bf11
From: <sip:UEa1_public_1@under.test.com>;tag=9fxced76sl
To: <sip:UEa2_public_1@under.test.com>;tag=314259
Call-ID: 3848276298220188511@under.test.com
CSeq: 2 BYE
Content-Length: 0

22. INVITE P-CSCF -> NUT

INVITE sip:UEa1_public_1@node.under.test.com:1357 SIP/2.0
Via: SIP/2.0/UDP p.a1.under.test.com:10001;branch=z9hG4bK431e418c233,
SIP/2.0/UDP s.a1.under.test.com;branch=z9hG4bK431e418c4.2;received=3ffe:501:ffff:100::30,
SIP/2.0/UDP i.a1.under.test.com;branch=z9hG4bKnashds418c5a;received=3ffe:501:ffff:100::20,
SIP/2.0/UDP s.a2.under.test.com;branch=z9hG4bK721e418c657u;received=3ffe:501:ffff:200::30,
SIP/2.0/UDP p.a2.under.test.com;branch=z9hG4bKnaghc45ca8;received=3ffe:501:ffff:200::10,
SIP/2.0/UDP [3ffe:501:ffff:2000::1000]:22222;branch=z9hG4bKnashds45ba91
Record-Route: <sip:p.a1.under.test.com:10001;lr>,<sip:s.a1.under.test.com;lr>,
<sip:s.a2.under.test.com;lr>,<sip:p.a2.under.test.com;lr>
Max-Forwards: 65
From: <sip:UEa2_public_1@under.test.com>;tag=10fxced76sl
To: <sip:UEa1_public_1@under.test.com>
Call-ID: 3848276298220188511@under.test.com
CSeq: 1 INVITE
Contact: <sip:UEa2_public_1@nodea2.under.test.com:22222>
Supported:
Allow: INVITE,ACK,CANCEL,OPTIONS,BYE
Allow-Events: reg
Accept: application/sdp,application/3gpp-ims+xml
P-Called-Party-ID: <sip:UEa1_public_1@under.test.com>



Content-Type: application/sdp

Content-Length: 154

```
v=0
o=UEa2 2890844526 2890844526 IN IP6 nodea2.under.test.com
s=-
c=IN IP6 nodea2.under.test.com
t=0 0
m=audio 49172 RTP/AVP 0
b=AS:75
a=rtpmap:0 PCMU/8000
```

23. < No response or ICMP error >

[OBSERVABLE RESULTS]

*1: 19 ACK with SA2 from NUT to P-CSCF

See generic_ACK

- Security behavior:

The newly established set of security associations SHALL be used for further messages sent towards the P-CSCF as appropriate.

[TS24229-5.1-237]

The previous security associations SHALL be replaced the new security associations.[TS33203-7.4-1]

The sever ports of UE and P-CSCF SHALL not be changed, while the protected client ports of UE and P-CSCF SHALL change.[TS33203-7.4-2]

*2: 20 BYE with SA2 from NUT to P-CSCF

See generic_BYE

- Security behavior:

The newly established set of security associations SHALL be used for

further messages sent towards the P-CSCF as appropriate.[TS24229-5.1-237]



*3: 23 No response or ICMP error

- Security behavior:

The newly established set of security associations SHALL be used for further messages sent towards the P-CSCF as appropriate.[TS24229-5.1-237]

The old set of security associations SHALL be deleted after all SIP transactions that use the old set of security associations are completed.
[TS24229-5.1-240]

4.1.18 UE-RG-B-18-AKA - Invalid authentication parameter (MAC) and 403 response

[NAME]

UE-RG-B-18-AKA - Invalid authentication parameter (MAC) and 403 response

[TARGET]

IMS User Equipment (NUT)

[PURPOSE]

- (1) To verify that the UEa1 properly responds with a further REGISTER indicating to the S-CSCF that the challenge has been deemed invalid
- (2) To verify that the UEa1 properly considers the registration to have failed and deletes the temporary set of security associations it was trying to establish when a 403 (Forbidden) response is received.
- (3) To verify that the UEa1 properly resends a new REGISTER with the old set of security associations.
- (4) To verify that the UEa1 properly sends an unprotected REGISTER message when the old set of security associations are no longer active at the P-CSCF.

[REFERENCE]

TS24.229 5.1.1.2.1
TS24.229 5.1.1.2.2
TS24.229 5.1.1.3
TS24.229 5.1.1.5.1



TS24.229 5.1.1.5.3

[REQUIREMENT]
NONE

[PARAMETER(NUT)]

public-user-id : sip:UEa1_public_1@under.test.com
private-user-id : UEa1_private@under.test.com
contact_URI : sip:UEa1_public_1@node.under.test.com
HOMENETWORK Domain : sip:under.test.com

[PARAMETER(TESTER)]

P-CSCFa1 : sip:p.a1.under.test.com
S-CSCFa1 : sip:s.a1.under.test.com

[ADDRESS]

UEa1(NUT) : 3ffe:501:fff:1000::1000
Router(R1) : 3ffe:501:fff:1000::1
P-CSCFa1 : 3ffe:501:fff:100::10
I-CSCFa1 : 3ffe:501:fff:100::20
S-CSCFa1 : 3ffe:501:fff:100::30
DNS : 3ffe:501:fff:100::40
DHCP : 3ffe:501:fff:100::50

[TOPOLOGY]

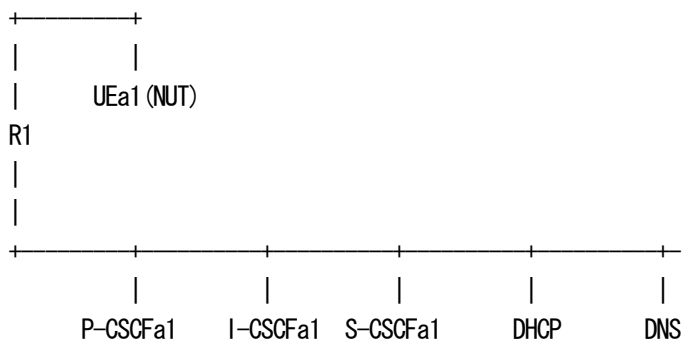

[INITIALIZATION]

Set up IP Address using A or B.



A. Router Advertisement

B. DHCPv6

(NUT)

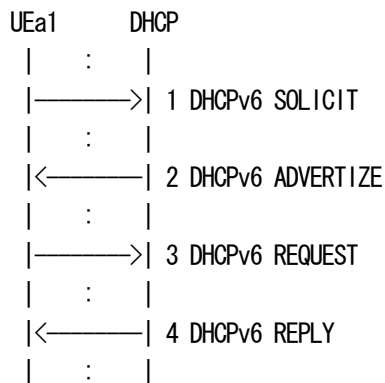

[PROCEDURE]

Home Network

(NUT)

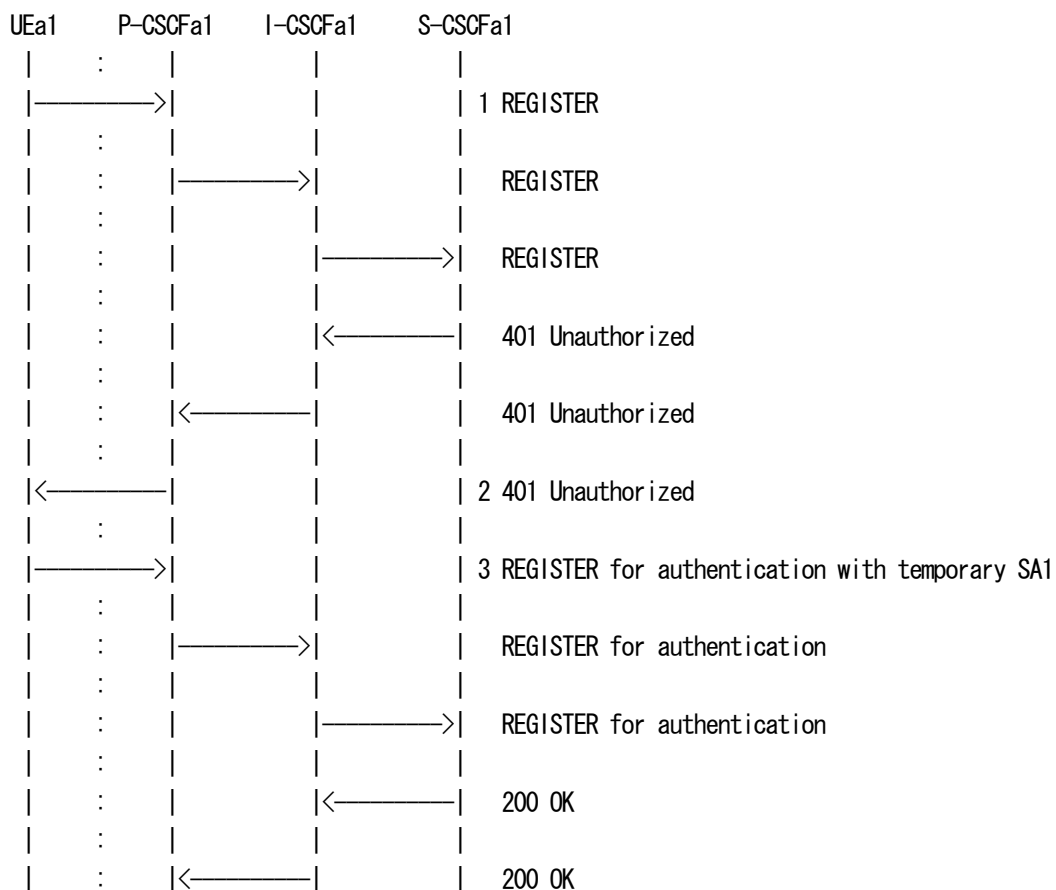

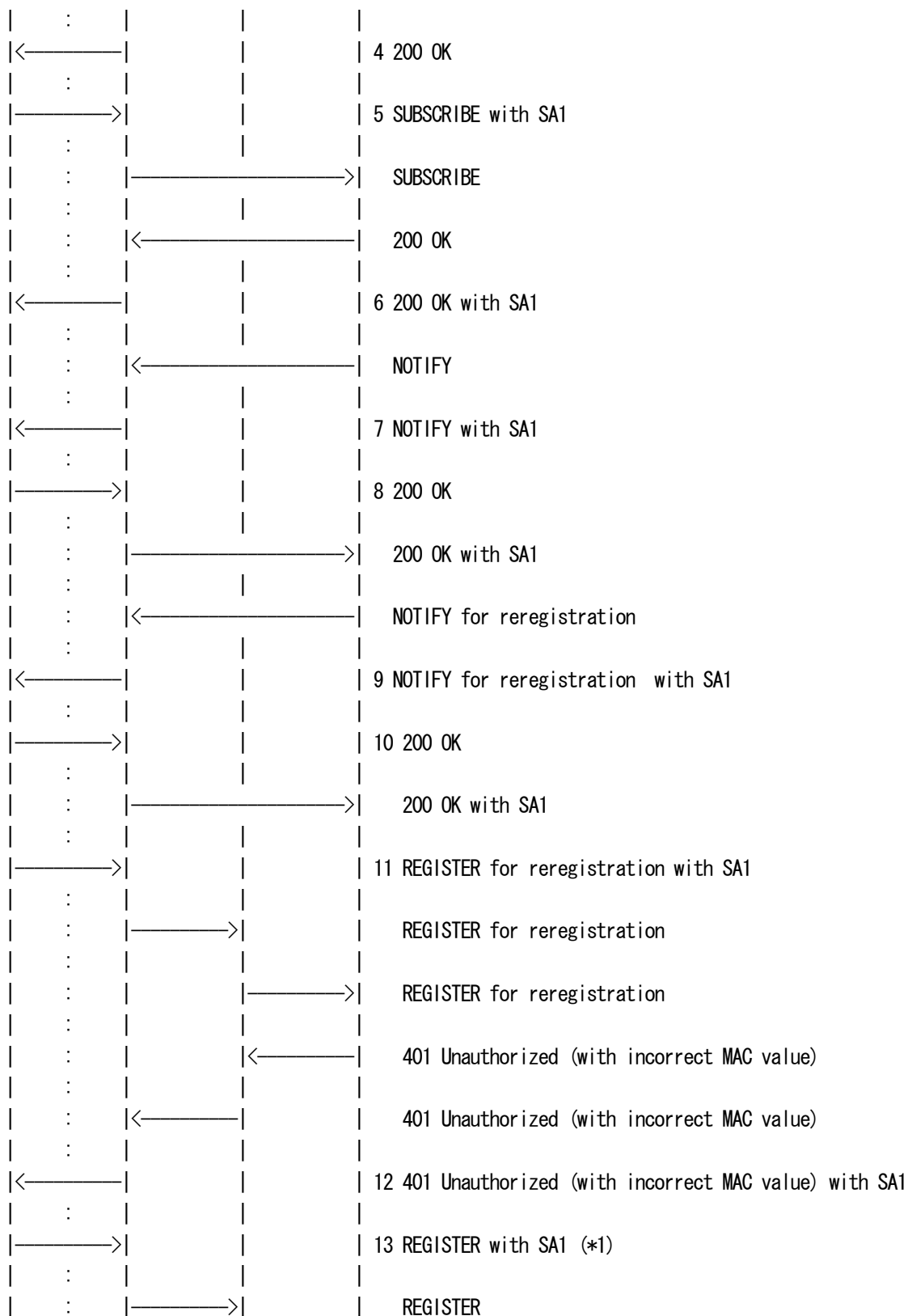

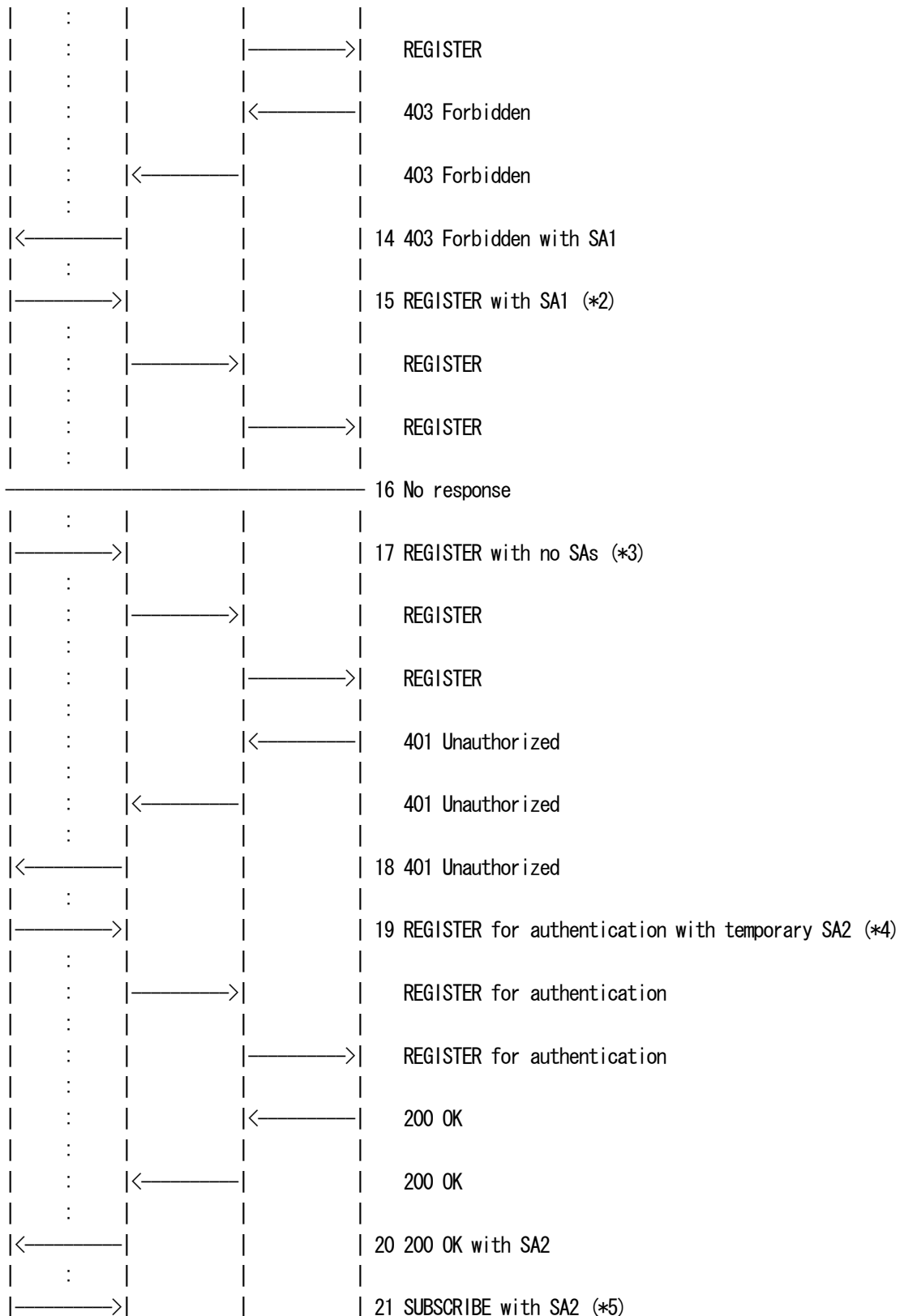

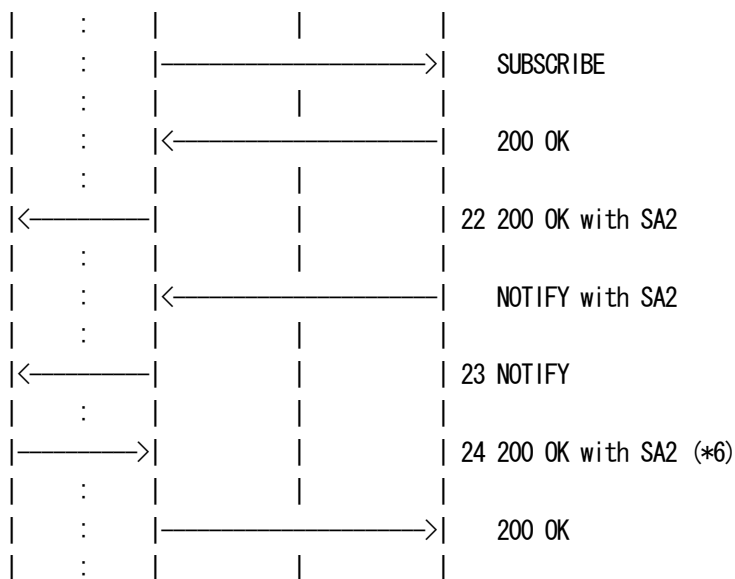

- 1 NUT sends REGISTER with no SA
- 2 NUT receives 401 Unauthorized with no SA
- 3 NUT sends REGISTER for authentication with temporary SA1
- 4 NUT receives 200 OK with SA1
- 5 NUT sends SUBSCRIBE
- 6 NUT receives 200 OK
- 7 NUT receives NOTIFY
- 8 NUT sends 200 OK
- 9 NUT receives NOTIFY
- 10 NUT sends 200 OK
- 11 NUT sends REGISTER with SA1
- 12 NUT receives 401 Unauthorized (with incorrect MAC value) with SA1
- 13 NUT sends REGISTER with SA1
- 14 NUT receives 403 Forbidden with temporary SA2
- 15 NUT sends REGISTER with SA1
- 16 NUT receives no response
- 17 NUT sends REGISTER with no SAs
- 18 NUT receives 401 Unauthorized with no SAs
- 19 NUT sends REGISTER for authentication with temporary SA2
- 20 NUT receives 200 OK with SA2
- 21 NUT sends SUBSCRIBE with SA2
- 22 NUT receives 200 OK with SA2
- 23 NUT receives NOTIFY with SA2
- 24 NUT sends 200 OK with SA2

=== Message example ===

As regards the message 1-11, please refer to the message 1-11 in UE-RG-B-3-AKA.



12. 401 Unauthorized P-CSCF -> NUT

SIP/2.0 401 Unauthorized

Via: SIP/2.0/UDP [3ffe:501:ffff:1000::1000]:1357;branch=z9hG4bKnashds9

WWW-Authenticate: Digest realm="under.test.com",

nonce=base64(RAND + AUTN including a invalid MAC + server specific data), algorithm=AKAv1-MD5

From: <sip:UEa1_public_1@under.test.com>;tag=4fa4

To: <sip:UEa1_public_1@under.test.com>;tag=5ef6

Call-ID: apb03a0s09dkjdfglkj49111@under.test.com

CSeq: 3 REGISTER

Security-Server: ipsec-3gpp; alg=hmac-sha-1-96; spi-c=266; spi-s=267; port-c=10004; port-s=10001

Content-Length: 0

13. REGISTER NUT -> P-CSCF

REGISTER sip:under.test.com SIP/2.0

Via: SIP/2.0/UDP [3ffe:501:ffff:1000::1000]:1357;branch=z9hG4bKnashds10

Max-Forwards: 70

From: <sip:UEa1_public_1@under.test.com>;tag=4fa4

To: <sip:UEa1_public_1@under.test.com>

Contact: <sip:UEa1_public_1@node.under.test.com:1357>;expires=600000

Call-ID: apb03a0s09dkjdfglkj49111@under.test.com

Authorization: Digest username="UEa1_private@under.test.com", realm="under.test.com",

algorithm=AKAv1-MD5, nonce=base64(RAND + AUTN including a invalid MAC + server specific data),

uri="sip:under.test.com", response=""

Security-Client: ipsec-3gpp; mode="trans"; alg=hmac-sha-1-96; spi-c=33456789; spi-s=22345678;

port-c=3468; port-s=1357

Security-Verify: ipsec-3gpp; alg=hmac-sha-1-96; spi-c=266; spi-s=267; port-c=10004; port-s=10001

Require: sec-agree

Proxy-Require: sec-agree

CSeq: 4 REGISTER

Supported: path

Content-Length: 0

14. 403 Forbidden P-CSCF -> NUT

SIP/2.0 403 Forbidden

Via: SIP/2.0/UDP [3ffe:501:ffff:1000::1000]:1357;branch=z9hG4bKnashds10

From: <sip:UEa1_public_1@under.test.com>;tag=4fa4

To: <sip:UEa1_public_1@under.test.com>;tag=5ef7

Call-ID: apb03a0s09dkjdfglkj49111@under.test.com

CSeq: 4 REGISTER

Content-Length: 0



15. REGISTER NUT -> P-CSCF

REGISTER sip:under.test.com SIP/2.0
Via: SIP/2.0/UDP [3ffe:501:ffff:1000::1000]:1357;branch=z9hG4bKnashdu8
Max-Forwards: 70
From: <sip:UEa1_public_1@under.test.com>;tag=5fa3
To: <sip:UEa1_public_1@under.test.com>
Contact: <sip:UEa1_public_1@node.under.test.com:1357>;expires=600000
Call-ID: bpb03a0s09dkjdfglkj49111@under.test.com
Authorization: Digest username="UEa1_private@under.test.com", realm="under.test.com", nonce="", uri="sip:under.test.com", response=""
Security-Client: ipsec-3gpp; mode="trans"; alg=hmac-sha-1-96; spi-c=43456789; spi-s=32345678; port-c=4468; port-s=1357
Require: sec-agree
Proxy-Require: sec-agree
CSeq: 1 REGISTER
Supported: path
Content-Length: 0

16. <No Response>

17. REGISTER NUT -> P-CSCF

REGISTER sip:under.test.com SIP/2.0
Via: SIP/2.0/UDP [3ffe:501:ffff:1000::1000]:5060;branch=z9hG4bKnashdv8
Max-Forwards: 70
From: <sip:UEa1_public_1@under.test.com>;tag=6fa3
To: <sip:UEa1_public_1@under.test.com>
Contact: <sip:UEa1_public_1@node.under.test.com>;expires=600000
Call-ID: cpb03a0s09dkjdfglkj49111@under.test.com
Authorization: Digest username="UEa1_private@under.test.com", realm="under.test.com", nonce="", uri="sip:under.test.com", response=""
Security-Client: ipsec-3gpp; mode="trans"; alg=hmac-sha-1-96; spi-c=53456789; spi-s=42345678; port-c=5468; port-s=1357
Require: sec-agree
Proxy-Require: sec-agree
CSeq: 1 REGISTER
Supported: path
Content-Length: 0



18. 401 Unauthorized P-CSCF -> NUT

SIP/2.0 401 Unauthorized

Via: SIP/2.0/UDP [3ffe:501:ffff:1000::1000]:5060;branch=z9hG4bKnashdv8

WWW-Authenticate: Digest realm="under.test.com",

nonce="J2U8vpY3qJhiuZnrke/ObponGSCcLm5iR+WCRkWYoM", algorithm=AKAv1-MD5

From: <sip:UEa1_public_1@under.test.com>;tag=6fa3

To: <sip:UEa1_public_1@under.test.com>;tag=6ef4

Call-ID: cpb03a0s09dkjdfglkj49111@under.test.com

Security-Server: ipsec-3gpp; alg=hmac-sha-1-96; spi-c=276; spi-s=277; port-c=10006; port-s=10001

CSeq: 1 REGISTER

Content-Length: 0

19. REGISTER NUT -> P-CSCF

REGISTER sip:under.test.com SIP/2.0

Via: SIP/2.0/UDP [3ffe:501:ffff:1000::1000]:1357;branch=z9hG4bKnashdv9

Max-Forwards: 70

From: <sip:UEa1_public_1@under.test.com>;tag=6fa3

To: <sip:UEa1_public_1@under.test.com>

Contact: <sip:UEa1_public_1@node.under.test.com:1357>;expires=600000

Call-ID: cpb03a0s09dkjdfglkj49111@under.test.com

Authorization: Digest username="UEa1_private@under.test.com", realm="under.test.com",
algorithm=AKAv1-MD5, nonce="J2U8vpY3qJhiuZnrke/ObponGSCcLm5iR+WCRkWYoM",
uri="sip:under.test.com", response="7729fae49393a05397450978507c4ef2"

Security-Client: ipsec-3gpp; mode="trans"; alg=hmac-sha-1-96; spi-c=53456789; spi-s=42345678;
port-c=5468; port-s=1357

Security-Verify: ipsec-3gpp; alg=hmac-sha-1-96; spi-c=276; spi-s=277; port-c=10006; port-s=10001

Require: sec-agree

Proxy-Require: sec-agree

CSeq: 2 REGISTER

Supported: path

Content-Length: 0

20. 200 OK P-CSCF -> NUT

SIP/2.0 200 OK

Via: SIP/2.0/UDP [3ffe:501:ffff:1000::1000]:1357;branch=z9hG4bKnashdv9

From: <sip:UEa1_public_1@under.test.com>;tag=6fa3

To: <sip:UEa1_public_1@under.test.com>;tag=6ef5

Call-ID: cpb03a0s09dkjdfglkj49111@under.test.com

Contact: <sip:UEa1_public_1@node.under.test.com:1357>;expires=600000

Path: <sip:term@p.a1.under.test.com;lr>

Service-Route: <sip:orig@s.a1.under.test.com;lr>



CSeq: 2 REGISTER
P-Associated-URI: <sip:UEa1_public_1@under.test.com>
Date: Wed, 11 July 2001 08:49:37 GMT
Content-Length: 0

21. SUBSCRIBE NUT -> P-CSCF

SUBSCRIBE sip:UEa1_public_1@under.test.com SIP/2.0
Via: SIP/2.0/UDP [3ffe:501:ffff:1000::1000]:1357;branch=z9hG4bKnashdsb1
Max-Forwards: 70
Route: <sip:p.a1.under.test.com:10001;lr>,<sip:orig@s.a1.under.test.com;lr>
From: <sip:UEa1_public_1@under.test.com>;tag=41415
To: <sip:UEa1_public_1@under.test.com>
Require: sec-agree
Proxy-Require: sec-agree
Call-ID: c89rjhnedlrfjfsj40a222@under.test.com
CSeq: 1 SUBSCRIBE
Allow-Events: reg
Event: reg
Security-Verify: ipsec-3gpp; alg=hmac-sha-1-96; spi-c=276; spi-s=277; port-c=10006; port-s=10001
Expires: 600000
Contact: <sip:UEa1_public_1@node.under.test.com:1357>
Content-Length: 0

22. 200 OK P-CSCF -> NUT

SIP/2.0 200 OK
Via: SIP/2.0/UDP [3ffe:501:ffff:1000::1000]:1357;branch=z9hG4bKnashdsb1
Record-Route: <sip:p.a1.under.test.com:10001;lr>
From: <sip:UEa1_public_1@under.test.com>;tag=41415
To: <sip:UEa1_public_1@under.test.com>;tag=251170
Call-ID: c89rjhnedlrfjfsj40a222@under.test.com
CSeq: 1 SUBSCRIBE
Allow-Events: reg
Expires: 600000
Contact: <sip:s.a1.under.test.com>
Content-Length: 0

23. NOTIFY P-CSCF -> NUT

NOTIFY sip:UEa1_public_1@node.under.test.com:1357 SIP/2.0
Via: SIP/2.0/UDP p.a1.under.test.com:10001;branch=z9hG4bK240f82.1,
SIP/2.0/UDP s.a1.under.test.com;branch=z9hG4bK332b56.1;received=3ffe:501:ffff:100::30



Max-Forwards: 69
From: <sip:UEa1_public_1@under.test.com>;tag=251170
To: <sip:UEa1_public_1@under.test.com>;tag=41415
Call-ID: c89rjhnedlrfjflsj40a222@under.test.com
CSeq: 1 NOTIFY
Contact: <sip:s.a1.under.test.com>
Subscription-State: active;expires=600000
Event: reg
Content-Type: application/reginfo+xml
Content-Length: (...)

```
<?xml version="1.0"?>
<reginfo xmlns="urn:ietf:params:xml:ns:reginfo" version="0" state="full">
  <registration aor="sip:UEa1_public_1@under.test.com" id="a7" state="active">
    <contact id="76" state="active" event="registered">
      <uri>sip:UEa1_public_1@node.under.test.com</uri>
    </contact>
  </registration>
</reginfo>
```

24. 200 OK NUT -> P-CSCF
SIP/2.0 200 OK
Via: SIP/2.0/UDP p.a1.under.test.com:10001;branch=z9hG4bK240f82.1;
received=3ffe:501:fff:100::10,SIP/2.0/UDP s.a1.under.test.com;branch=z9hG4bK332b56.1;
received=3ffe:501:fff:100::30
From: <sip:UEa1_public_1@under.test.com>;tag=251170
To: <sip:UEa1_public_1@under.test.com>;tag=41415
Call-ID: c89rjhnedlrfjflsj40a222@under.test.com
CSeq: 1 NOTIFY
Content-Length: 0

[OBSERVABLE RESULTS]

*1: 13 REGISTER for authentication with SA1 from NUT to P-CSCF

See generic_re_REGISTER

```
- Exception{
  * Authorization
    The response directive in Authorization header field SHALL be set
    to the last calculated response value.[TS24229-5.1-187]
}
```



The REGISTRER request for authentication that includes the cause of failure SHALL be sent towards the Home Network.[TS33203-6.1-26]

The client SHOULD NOT retry the same request without modification.
[RFC3261-21.4-1]

- Security behavior:

The REGISTER request SHALL be sent using an existing set of security associations.[TS24229-5.1-250]

A temporary set of security associations SHALL not be created.
[TS24229-5.1-252]

The REGISTER request which may pass through an already established SA and indicate a network authentication failure SHALL be sent to the P-CSCF.
[TS33203-7.3-5]

- Header field:

This new request SHOULD have the same value of the Call-ID, To, and From of the previous request, but the CSeq should contain a new sequence number that is one higher than the previous. [RFC3261-8.1-62]

* Authorization

No AUTS directive and an empty response directive SHALL be contained in the subsequent REGISTER request.[TS24229-5.1-247]

* Security-Client

The UE shall populate a new Security-Client header field within the REGISTER request and associated contact address, set to specify the security mechanism it supports, the IPsec layer algorithms for integrity and confidentiality protection it supports and the parameters needed for the new security association setup.[TS24229-5.1-251]

*2: 15 REGISTER with SA1 from NUT to P-CSCF

See generic_REGISTER

The registration SHALL be considered to have failed if 403 (Forbidden) response is received.[TS24229-5.1-243]



The temporary set of security associations SHALL be deleted and the old set of security associations SHALL be used.[TS24229-5.1-244]

The client SHOULD NOT retry the same request without modification.
[RFC3261-21.4-1]

*3: 17 REGISTER with no SAs from NUT to P-CSCF

See generic_REGISTER

- Security behavior:

An unprotected REGISTER request SHOULD be sent when the security associations no longer active at the P CSCF.[TS33203-7.4-9]

*4: 19 REGISTER for authentication with temporary SA3 from NUT to P-CSCF

See generic_Auth_REGISTER

*5: 21 SUBSCRIBE with SA2 from NUT to P-CSCF

See generic_SUBSCRIBE

*6: 24 NOTIFY 200 OK with SA2 from NUT to P-CSCF

See generic_200-NOTIFY

4.1.19 UE-RG-B-19-AKA - Invalid authentication parameter(SQN)

[NAME]

UE-RG-B-19-AKA - Invalid authentication parameter (SQN)

[TARGET]

IMS User Equipment (NUT)

[PURPOSE]

To verify that the UEa1 properly responds with a further REGISTER indicating to the S-CSCF that the challenge has been deemed invalid and only responds to two consecutive invalid challenges and does not automatically attempt authentication after two consecutive failed attempts to authenticate.



[REFERENCE]
TS24.229 5.1.1.5.3
TS24.229 5.1.1.5.12

[REQUIREMENT]
NONE

[PARAMETER(NUT)]
public-user-id : sip:UEa1_public_1@under.test.com
private-user-id : UEa1_private@under.test.com
contact_URI : sip:UEa1_public_1@node.under.test.com
HOMENETWORK Domain : sip:under.test.com

[PARAMETER(TESTER)]
P-CSCFa1 : sip:p.a1.under.test.com
S-CSCFa1 : sip:s.a1.under.test.com

[ADDRESS]
UEa1(NUT) : 3ffe:501:fff:1000::1000
Router(R1) : 3ffe:501:fff:1000::1
P-CSCFa1 : 3ffe:501:fff:100::10
I-CSCFa1 : 3ffe:501:fff:100::20
S-CSCFa1 : 3ffe:501:fff:100::30
DNS : 3ffe:501:fff:100::40
DHCP : 3ffe:501:fff:100::50

[TOPOLOGY]

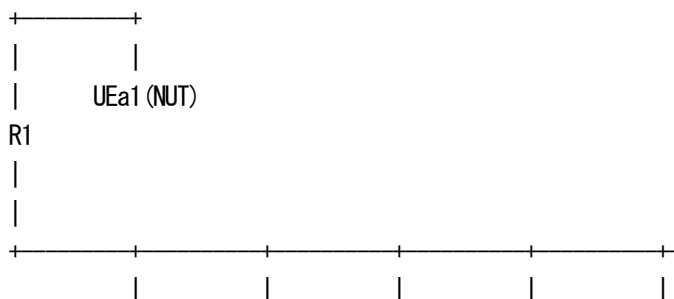



P-CSCFa1 I-CSCFa1 S-CSCFa1 DHCP DNS

[INITIALIZATION]

Set up IP Address using A or B.

A. Router Advertisement

B. DHCPv6

(NUT)

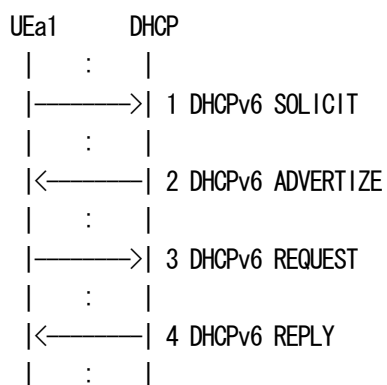

[PROCEDURE]

Home Network

(NUT)

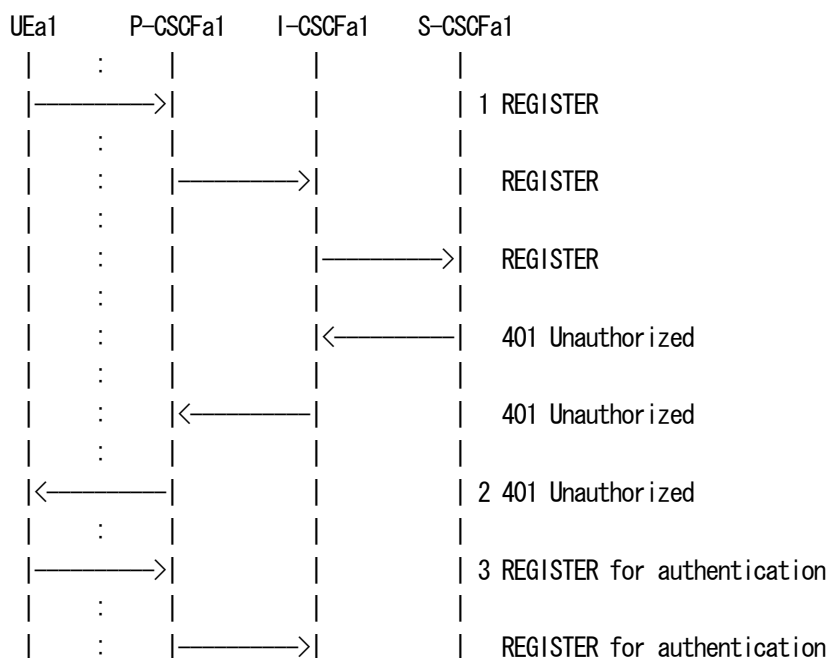

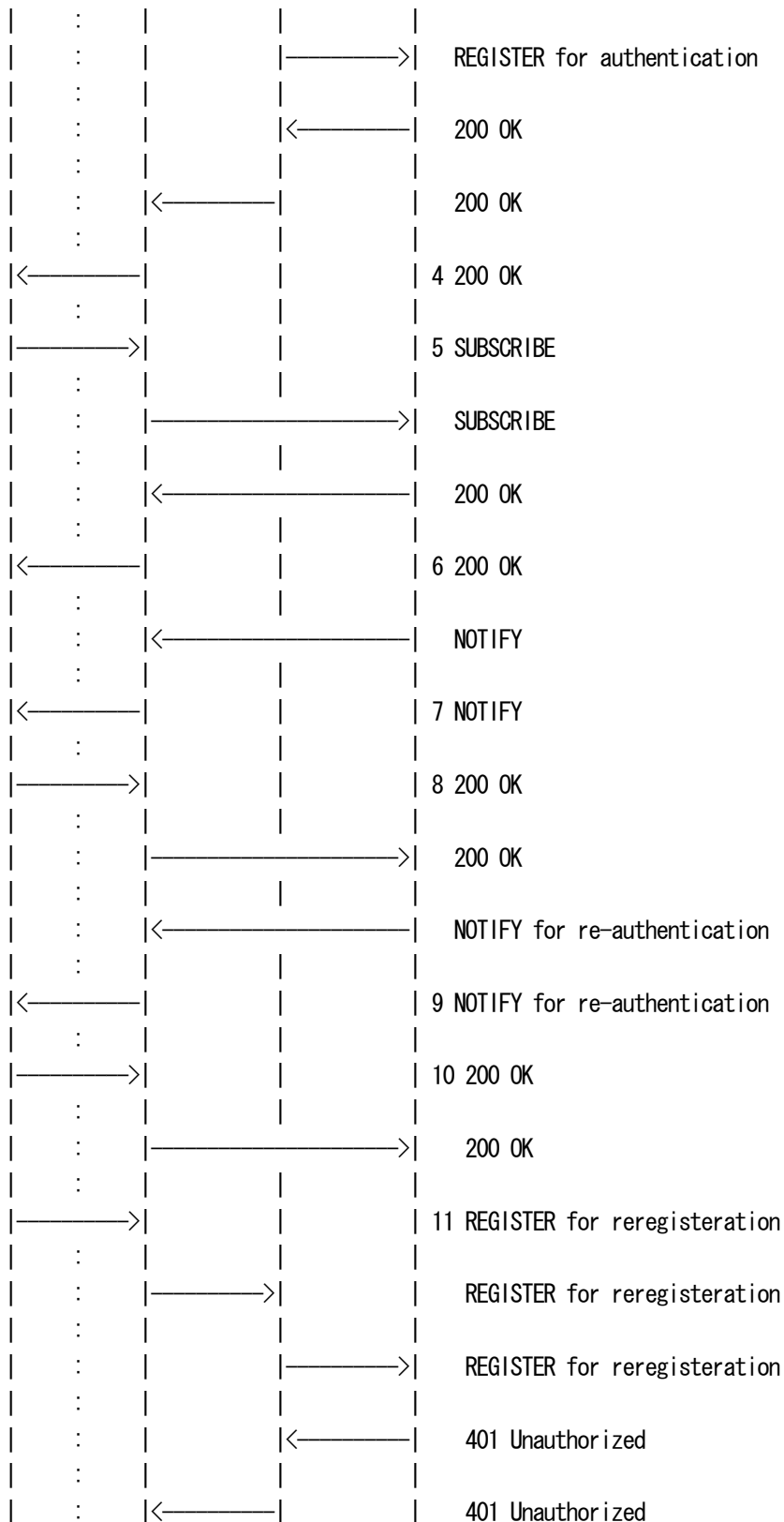

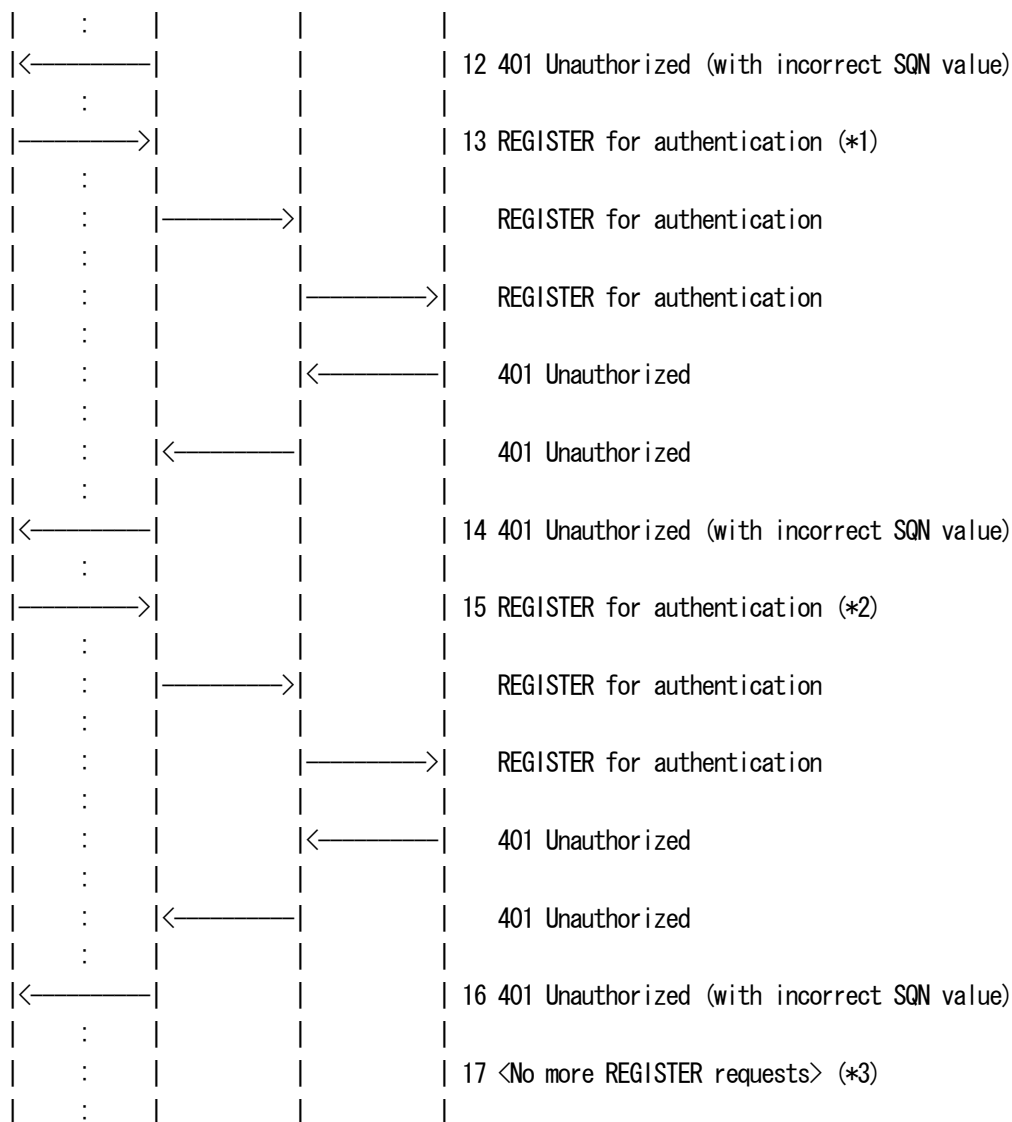

- 1 NUT sends REGISTER
- 2 NUT receives 401 Unauthorized
- 3 NUT sends REGISTER for authentication
- 4 NUT receives 200 OK
- 5 NUT sends SUBSCRIBE
- 6 NUT receives 200 OK
- 7 NUT receives NOTIFY
- 8 NUT sends 200 OK
- 9 NUT receives NOTIFY for re-authentication
- 10 NUT sends 200 OK
- 11 NUT sends REGISTER for reregistration
- 12 NUT receives 401 Unauthorized
- 13 NUT sends REGISTER for authentication



14 NUT receives 401 Unauthorized
15 NUT sends REGISTER for authentication
16 NUT receives 401 Unauthorized
17 <No more REGISTER requests>

=== Message example ===

As regards the message 1-11, please refer to the message 1-11 in UE-RG-B-3-AKA.

12. 401 Unauthorized P-CSCF -> NUT
SIP/2.0 401 Unauthorized
Via: SIP/2.0/UDP [3ffe:501:ffff:1000::1000]:1357;branch=z9hG4bKnashds9
WWW-Authenticate: Digest realm="under.test.com",
nonce=base64(RAND + AUTN including a invalid SQN + server specific data), algorithm=AKAv1-MD5
From: <sip:UEa1_public_1@under.test.com>;tag=4fa4
To: <sip:UEa1_public_1@under.test.com>;tag=5ef6
Call-ID: apb03a0s09dkjdfglkj49111@under.test.com
CSeq: 3 REGISTER
Security-Server: ipsec-3gpp; alg=hmac-sha-1-96; spi-c=266; spi-s=267; port-c=10004; port-s=10001
Content-Length: 0

13. REGISTER NUT -> P-CSCF
REGISTER sip:under.test.com SIP/2.0
Via: SIP/2.0/UDP [3ffe:501:ffff:1000::1000]:1357;branch=z9hG4bKnashds10
Max-Forwards: 70
From: <sip:UEa1_public_1@under.test.com>;tag=4fa4
To: <sip:UEa1_public_1@under.test.com>
Contact: <sip:UEa1_public_1@node.under.test.com:1357>;expires=600000
Call-ID: apb03a0s09dkjdfglkj49111@under.test.com
Authorization: Digest username="UEa1_private@under.test.com", realm="under.test.com",
algorithm=AKAv1-MD5, nonce=base64(RAND + AUTN including a invalid SQN + server specific data),
uri="sip:under.test.com", auts="5PYxMuX2NOT2NeQ=" response="calculated without password"
Security-Client: ipsec-3gpp; mode="trans"; alg=hmac-sha-1-96; spi-c=43456789; spi-s=32345678;
port-c=4468; port-s=1357
Security-Verify: ipsec-3gpp; alg=hmac-sha-1-96; spi-c=256; spi-s=257; port-c=10002; port-s=10001
Require: sec-agree
Proxy-Require: sec-agree
CSeq: 4 REGISTER
Supported: path
Content-Length: 0

14. 401 Unauthorized P-CSCF -> NUT



SIP/2.0 401 Unauthorized

Via: SIP/2.0/UDP [3ffe:501:ffff:1000::1000]:1357;branch=z9hG4bKnashds10
WWW-Authenticate: Digest realm="under.test.com",
nonce=base64(RAND + AUTN including a invalid SQN + server specific data), algorithm=AKAv1-MD5
From: <sip:UEa1_public_1@under.test.com>;tag=4fa4
To: <sip:UEa1_public_1@under.test.com>;tag=5ef7
Call-ID: apb03a0s09dkjdfglkj49111@under.test.com
CSeq: 4 REGISTER
Security-Server: ipsec-3gpp; alg=hmac-sha-1-96; spi-c=276; spi-s=277; port-c=10006; port-s=10001
Content-Length: 0

15. REGISTER NUT -> P-CSCF

REGISTER sip:under.test.com SIP/2.0
Via: SIP/2.0/UDP [3ffe:501:ffff:1000::1000]:1357;branch=z9hG4bKnashds11
Max-Forwards: 70
From: <sip:UEa1_public_1@under.test.com>;tag=4fa4
To: <sip:UEa1_public_1@under.test.com>
Contact: <sip:UEa1_public_1@node.under.test.com:1357>;expires=600000
Call-ID: apb03a0s09dkjdfglkj49111@under.test.com
Authorization: Digest username="UEa1_private@under.test.com", realm="under.test.com",
algorithm=AKAv1-MD5, nonce=base64(RAND + AUTN including a invalid SQN + server specific data),
uri="sip:under.test.com", auts="5PYxMuX2NOT2NeQ=" response="calculated without password"
Security-Client: ipsec-3gpp; mode="trans"; alg=hmac-sha-1-96; spi-c=53456789; spi-s=42345678;
port-c=5468; port-s=1357
Security-Verify: ipsec-3gpp; alg=hmac-sha-1-96; spi-c=256; spi-s=257; port-c=10002; port-s=10001
Require: sec-agree
Proxy-Require: sec-agree
CSeq: 5 REGISTER
Supported: path
Content-Length: 0

16. 401 Unauthorized P-CSCF -> NUT

SIP/2.0 401 Unauthorized
Via: SIP/2.0/UDP [3ffe:501:ffff:1000::1000]:1357;branch=z9hG4bKnashds11
WWW-Authenticate: Digest realm="under.test.com",
nonce=base64(RAND + AUTN including a invalid SQN + server specific data), algorithm=AKAv1-MD5
From: <sip:UEa1_public_1@under.test.com>;tag=4fa4
To: <sip:UEa1_public_1@under.test.com>;tag=5ef8
Call-ID: apb03a0s09dkjdfglkj49111@under.test.com
CSeq: 5 REGISTER
Security-Server: ipsec-3gpp; alg=hmac-sha-1-96; spi-c=286; spi-s=287; port-c=10008; port-s=10001



Content-Length: 0

17. <No more REGISTER request>

[OBSERVABLE RESULTS]

*1: 13 REGISTER for authentication from NUT to P-CSCF

See generic_re_REGISTER

- Exception{

* Authorization

The response directive in Authorization header field SHALL be set to the last calculated response value.[TS24229-5.1-187]

}

The REGISTER request for authentication that includes the cause of failure SHALL be sent towards the Home Network.[TS33203-6.1-26]

The client SHOULD NOT retry the same request without modification. [RFC3261-21.4-1]

- Security behavior:

The REGISTER request SHALL be sent using an existing set of security associations.[TS24229-5.1-250]

A temporary set of security associations SHALL not be created. [TS24229-5.1-252]

The REGISTER request which may pass through an already established SA and indicate a network authentication failure SHALL be sent to the P-CSCF. [TS33203-7.3-5]

- Header field:

This new request SHOULD have the same value of the Call-ID, To, and From of the previous request, but the CSeq should contain a new sequence number that is one higher than the previous. [RFC3261-8.1-62]

* Authorization

The AUTC directive SHALL be contained in the subsequent REGISTER request.[TS24229-5.1-248]



The client MUST calculate its credentials using an empty password.
[RFC3310-3.4-1]

* Security-Client

The UE shall populate a new Security-Client header field within the REGISTER request and associated contact address, set to specify the security mechanism it supports, the IPsec layer algorithms for integrity and confidentiality protection it supports and the parameters needed for the new security association setup.[TS24229-5.1-251]

*2: 15 REGISTER for authentication from NUT to P-CSCF

See generic_re_REGISTER

- Exception{

* Authorization

The response directive in Authorization header field SHALL be set to the last calculated response value.[TS24229-5.1-187]

}

The REGISTER request for authentication that includes the cause of failure SHALL be sent towards the Home Network.[TS33203-6.1-26]

The client SHOULD NOT retry the same request without modification.
[RFC3261-21.4-1]

- Security behavior:

The REGISTER request SHALL be sent using an existing set of security associations.[TS24229-5.1-250]

A temporary set of security associations SHALL not be created.
[TS24229-5.1-252]

The REGISTER request which may pass through an already established SA and indicate a network authentication failure SHALL be sent to the P-CSCF.
[TS33203-7.3-5]

- Header field:

This new request SHOULD have the same value of the Call-ID, To, and From of the previous request, but the CSeq should contain a new sequence number that is one higher than the previous. [RFC3261-8.1-62]



* Authorization

The AUTS directive SHALL be contained in the subsequent REGISTER request.[TS24229-5.1-248]

The client MUST calculate its credentials using an empty password.
[RFC3310-3.4-1]

* Security-Client

Security-Client header field SHALL be set to the security mechanism it supports, the IPsec layer algorithms for integrity and confidentiality protection it supports and the new parameter values needed for the setup of two new pairs of security associations.[TS24229-5.1-251]

*3: 17 No more REGISTER request

The REGISTER request SHALL be only sent to two consecutive invalid challenges and SHALL not be automatically sent authentication after two consecutive failed attempts to authenticate.[TS24229-5.1-273]

4.1.20 UE-RG-B-20-AKA - User-initiated deregistration and dialog release

[NAME]

UE-RG-B-20-AKA - User-initiated deregistration and dialog release

[TARGET]

IMS User Equipment (NUT)

[PURPOSE]

To verify that UEa1 properly releases all dialogs related to the public user identity that is going to be deregistered or to one of the implicitly registered public user identities except the dialog used for subscription to reg event package.

[REFERENCE]

TS24.229 5.1.1.6.1

[REQUIREMENT]

NONE



[PARAMETER(NUT)]

public-user-id : sip:UEa1_public_1@under.test.com
private-user-id : UEa1_private@under.test.com
contact_URI : sip:UEa1_public_1@node.under.test.com
HOMENETWORK Domain : sip:under.test.com

[PARAMETER(TESTER)]

public-URI(UEa2) : sip:UEa2_public_1@under.test.com
P-CSCFa1 : sip:p.a1.under.test.com
S-CSCFa1 : sip:s.a1.under.test.com

[ADDRESS]

UEa1(NUT) : 3ffe:501:fff:1000::1000
Router(R1) : 3ffe:501:fff:1000::1
P-CSCFa1 : 3ffe:501:fff:100::10
I-CSCFa1 : 3ffe:501:fff:100::20
S-CSCFa1 : 3ffe:501:fff:100::30
DNS : 3ffe:501:fff:100::40
DHCP : 3ffe:501:fff:100::50
UEa2 : 3ffe:501:fff:2000::1000
P-CSCFa2 : 3ffe:501:fff:200::10
I-CSCFa2 : 3ffe:501:fff:200::20
S-CSCFa2 : 3ffe:501:fff:200::30

[TOPOLOGY]

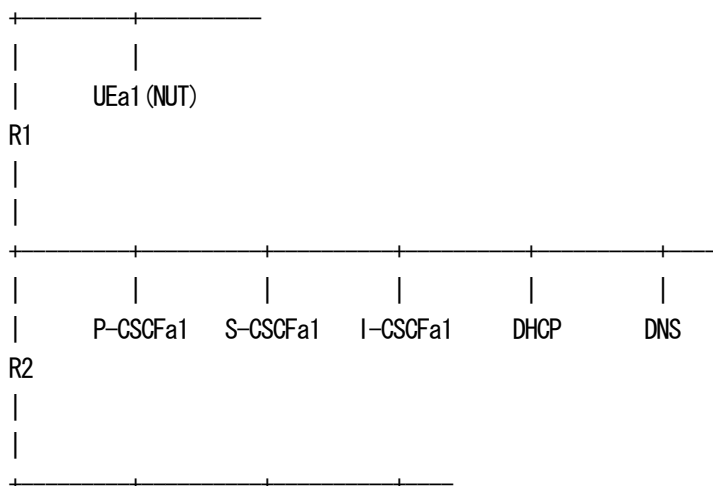

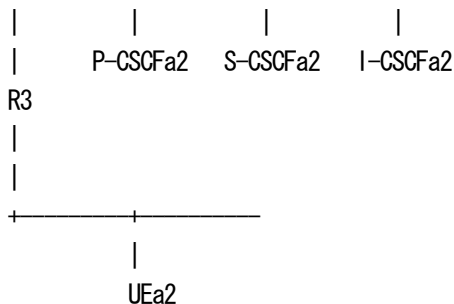

[INITIALIZATION]

Set up IP Address using A or B.

A. Router Advertisement

B. DHCPv6

(NUT)

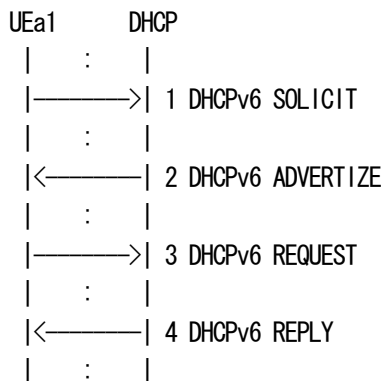

[PROCEDURE]

Home Network

(NUT)

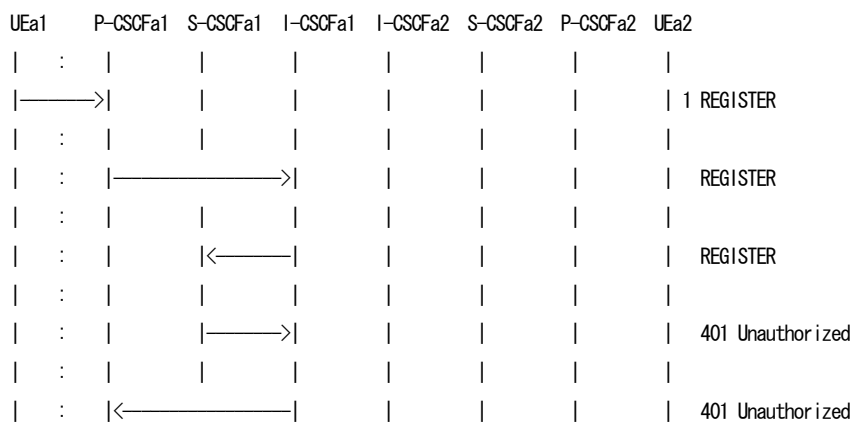

	:								
	<								2 401 Unauthorized
	:								
									3 REGISTER for authentication
	:								
									REGISTER for authentication
	:								
									REGISTER for authentication
	:								
									200 OK
	:								
	<								200 OK
	:								
	<								4 200 OK
	:								
									5 SUBSCRIBE
	:								
									SUBSCRIBE
	:								
	<								200 OK
	:								
	<								6 200 OK
	:								
	<								NOTIFY
	:								
	<								7 NOTIFY
	:								
									8 200 OK
	:								
									200 OK
	:								
									9 INVITE
	:								
									INVITE
	:								
	<								10 100 Trying
	:								
									INVITE
	:								
	<								100 Trying
	:								
									INVITE
	:								

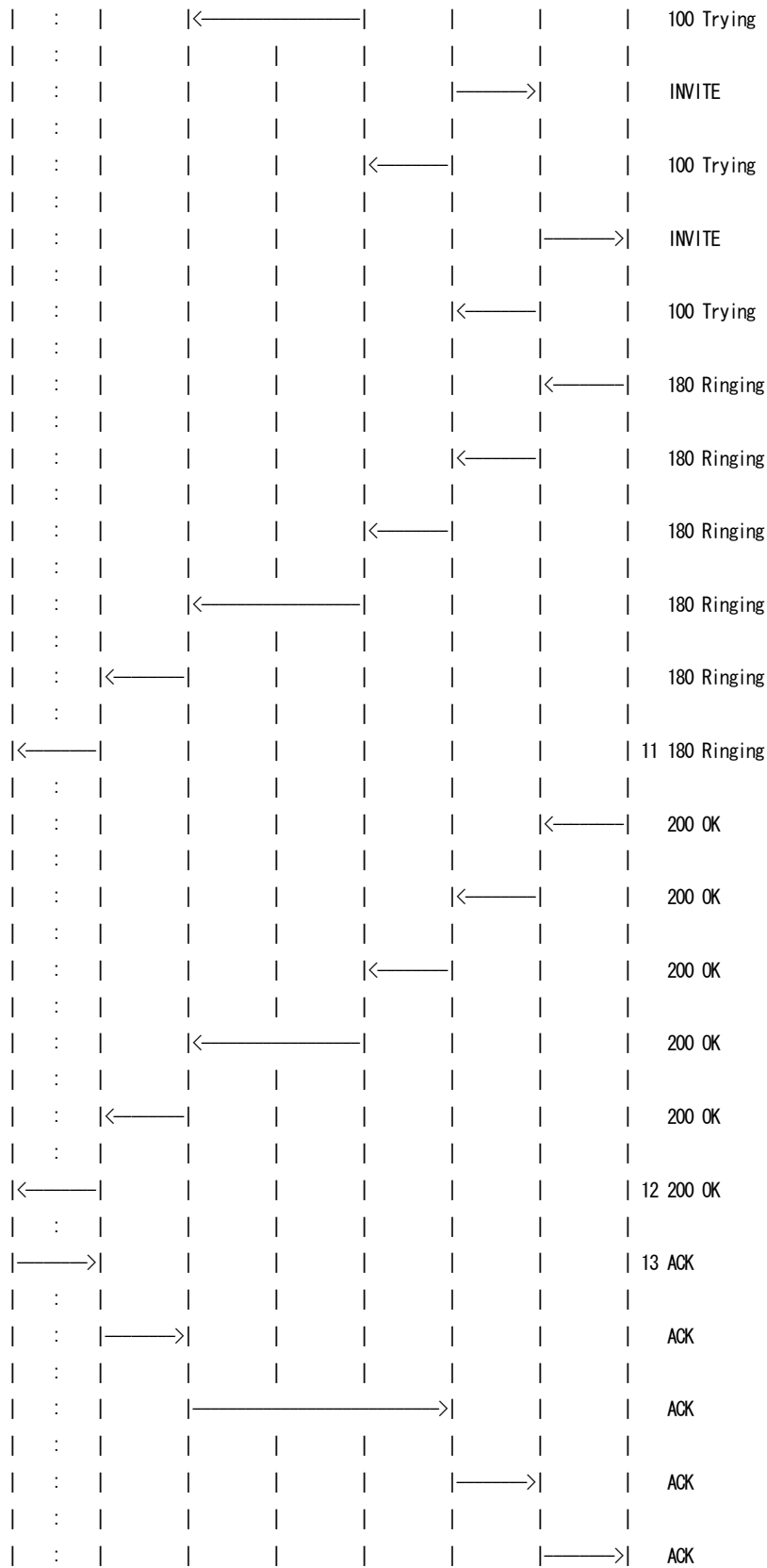

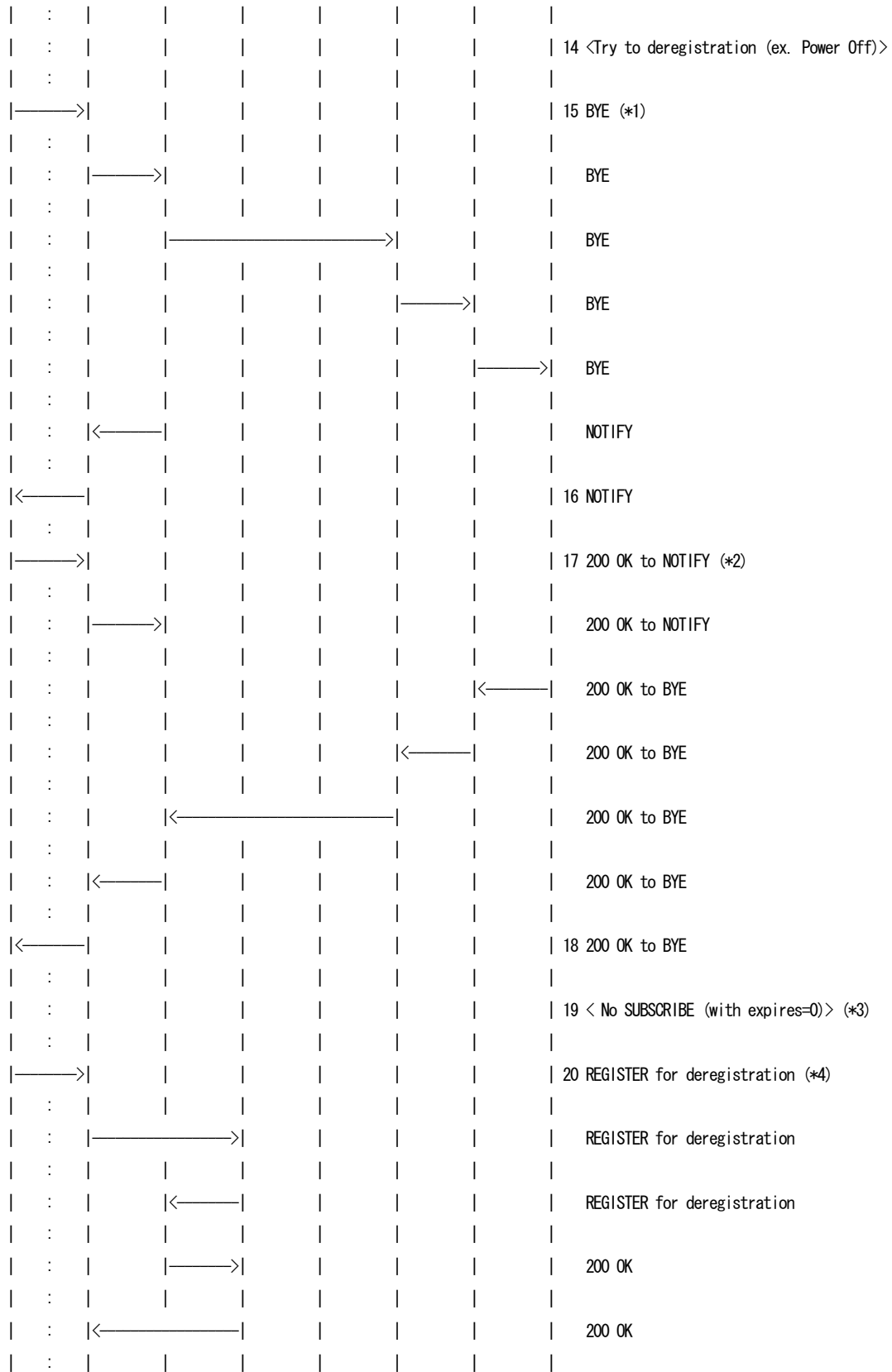



|←———| | | | | | | | 21 200 OK
| : | | | | | | | |

- 1 NUT sends REGISTER
- 2 NUT receives 401 Unauthorized
- 3 NUT sends REGISTER for authentication
- 4 NUT receives 200 OK
- 5 NUT sends SUBSCRIBE
- 6 NUT receives 200 OK
- 7 NUT receives NOTIFY
- 8 NUT sends 200 OK
- 9 NUT sends INVITE
- 10 NUT receives 100 Trying
- 11 NUT receives 180 Ringing
- 12 NUT receives 200 OK
- 13 NUT sends ACK
- 14 <Try to send De-REGISTER(ex. Power Off)>
- 15 NUT sends BYE
- 16 NUT receives NOTIFY
- 17 NUT sends 200 OK to NOTIFY
- 18 NUT receives 200 OK to BYE
- 19 <No SUBSCRIBE (with expires=0)>
- 20 NUT sends REGISTER for deregistration
- 21 NUT receives 200 OK

=== Message example ===

As regards the message 1-8, please refer to the message 1-8 in UE-RG-B-1-AKA.
As regards the message 9-13, please refer to the message 1-5 in UE-SE-B-1-AKA.

14. <Try to deregistration (ex. Power Off)>

15. BYE NUT -> P-CSCF

BYE sip:UEa2_public_1@nodea2.under.test.com:22222 SIP/2.0
Via: SIP/2.0/UDP [3ffe:501:ffff:1000::1000]:1357;branch=z9hG4bK74bf11
Route: <sip:p.a1.under.test.com:10001;lr>,<sip:s.a1.under.test.com;lr>,
<sip:s.a2.under.test.com;lr>,<sip:p.a2.under.test.com;lr>
Max-Forwards: 70
From: <sip:UEa1_public_1@under.test.com>;tag=9fxced76sl
To: <sip:UEa2_public_1@under.test.com>;tag=314259
Call-ID: 3848276298220188511@under.test.com
CSeq: 2 BYE



Content-Length: 0
Security-Verify: ipsec-3gpp; alg=hmac-sha-1-96; spi-c=256; spi-s=257; port-c=10002; port-s=10001
Require: sec-agree
Proxy-Require: sec-agree

16. NOTIFY P-CSCF -> NUT

NOTIFY sip:UEa1_public_1@node.under.test.com:1357 SIP/2.0
Via: SIP/2.0/UDP p.a1.under.test.com:10001;branch=z9hG4bK240f34.2,
SIP/2.0/UDP s.a1.under.test.com;branch=z9hG4bK332b23.2;received=3ffe:501:ffff:100::30
Max-Forwards: 69
From: <sip:UEa1_public_1@under.test.com>;tag=151170
To: <sip:UEa1_public_1@under.test.com>;tag=31415
Call-ID: b89rjhnedlrffflslj40a222@under.test.com
CSeq: 2 NOTIFY
Contact: <sip:s.a1.under.test.com>
Subscription-State: active;expires=600000
Event: reg
Content-Type: application/reginfo+xml
Content-Length: (...)

```
<?xml version="1.0"?>
<reginfo xmlns="urn:ietf:params:xml:ns:reginfo" version="1" state="full">
  <registration aor="sip:UEa1_public_1@under.test.com" id="a7" state="active">
    <contact id="76" state="active" event="registered">
      <uri>sip:UEa1_public_1@node.under.test.com</uri>
    </contact>
  </registration>
</reginfo>
```

17. 200 OK NUT -> P-CSCF

SIP/2.0 200 OK
Via: SIP/2.0/UDP p.a1.under.test.com:10001;branch=z9hG4bK240f34.2;received=3ffe:501:ffff:100::10,
SIP/2.0/UDP s.a1.under.test.com;branch=z9hG4bK332b23.2;received=3ffe:501:ffff:100::30
From: <sip:UEa1_public_1@under.test.com>;tag=151170
To: <sip:UEa1_public_1@under.test.com>;tag=31415
Call-ID: b89rjhnedlrffflslj40a222@under.test.com
CSeq: 2 NOTIFY
Content-Length: 0

18. 200 OK P-CSCF -> NUT



SIP/2.0 200 OK

Via: SIP/2.0/UDP [3ffe:501:ffff:1000::1000]:1357;branch=z9hG4bK74bf11

From: <sip:UEa1_public_1@under.test.com>;tag=9fxced76sl

To: <sip:UEa2_public_1@under.test.com>;tag=314259

Call-ID: 3848276298220188511@under.test.com

CSeq: 2 BYE

Content-Length: 0

19. <No SUBSCRIBE with expires=0>

20. REGISTER NUT -> P-CSCF

REGISTER sip:under.test.com SIP/2.0

Via: SIP/2.0/UDP [3ffe:501:ffff:1000::1000]:1357;branch=z9hG4bKnashds9

Max-Forwards: 70

From: <sip:UEa1_public_1@under.test.com>;tag=4fa4

To: <sip:UEa1_public_1@under.test.com>

Contact: <sip:UEa1_public_1@node.under.test.com:1357>;expires=0

Call-ID: apb03a0s09dkjdfglkj49111@under.test.com

Authorization: Digest username="UEa1_private@under.test.com", realm="under.test.com",
nonce="11U8vpY3qJhiuZNRke/NaponGSCcLm5iR+WCRkVYoM", uri="sip:under.test.com",
response="6629fae49393a05397450978507c4ef1"

Security-Client: ipsec-3gpp; mode="trans"; alg=hmac-sha-1-96; spi-c=33456789; spi-s=22345678;
port-c=3468; port-s=1357

Security-Verify: ipsec-3gpp; alg=hmac-sha-1-96; spi-c=256; spi-s=257; port-c=10002; port-s=10001

Supported: path

Require: sec-agree

Proxy-Require: sec-agree

CSeq: 3 REGISTER

Content-Length: 0

21. 200 OK P-CSCF -> NUT

SIP/2.0 200 OK

Via: SIP/2.0/UDP [3ffe:501:ffff:1000::1000]:1357;branch=z9hG4bKnashds9

From: <sip:UEa1_public_1@under.test.com>;tag=4fa4

To: <sip:UEa1_public_1@under.test.com>;tag=5ef6

Call-ID: apb03a0s09dkjdfglkj49111@under.test.com

CSeq: 3 REGISTER

Contact: <sip:UEa1_public_1@node.under.test.com:1357>;expires=0

Path: <sip:term@p.a1.under.test.com;lr>

Service-Route: <sip:orig@s.a1.under.test.com;lr>



P-Associated-URI:

Date: Wed, 11 July 2001 08:49:37 GMT

Content-Length: 0

[OBSERVABLE RESULTS]

*1: 15 BYE from NUT to P-CSCF

See generic_BYE

All dialogs related to the public user identity that is going to be deregistered or to one of the implicitly registered public user identities SHALL REGISTER request for deregistration.[TS24229-5.1-292]

*2: 17 NOTIFY 200 OK from NUT to P-CSCF

See generic_200-NOTIFY

*3: 19 No SUBSCRIBE (with expires=0) from NUT to P-CSCF

The dialog SHALL not be released if the dialog that was established by the UE subscribing to the reg event package used the public user identity and the dialog is the only remaining dialog used for subscription to reg event package.[TS24229-5.1-293][TS24229-5.1-294][TS24229-5.1-295]

*4: 20 REGISTER for deregistration from NUT to P-CSCF

See generic_de_REGISTER

4.1.21 UE-RG-B-21-AKA - Reception of 401 response to user-initiated deregistration

[NAME]

UE-RG-B-21-AKA - Reception of 401 response to user-initiated deregistration

[TARGET]

IMS User Equipment (NUT)

[PURPOSE]

To verify that the UEa1 properly performs the authentication procedure when received



a 401 (Unauthorized) response to the REGISTER request for deregistration.

[REFERENCE]

TS24.229 5.1.1.5.1

TS24.229 5.1.1.6.1

[REQUIREMENT]

NONE

[PARAMETER(NUT)]

public-user-id : sip:UEa1_public_1@under.test.com
private-user-id : UEa1_private@under.test.com
contact_URI : sip:UEa1_public_1@node.under.test.com
HOMENETWORK Domain : sip:under.test.com

[PARAMETER(TESTER)]

P-CSCFa1 : sip:p.a1.under.test.com
S-CSCFa1 : sip:s.a1.under.test.com

[ADDRESS]

UEa1(NUT) : 3ffe:501:ffff:1000::1000
Router(R1) : 3ffe:501:ffff:1000::1
P-CSCFa1 : 3ffe:501:ffff:100::10
I-CSCFa1 : 3ffe:501:ffff:100::20
S-CSCFa1 : 3ffe:501:ffff:100::30
DNS : 3ffe:501:ffff:100::40
DHCP : 3ffe:501:ffff:100::50

[TOPOLOGY]

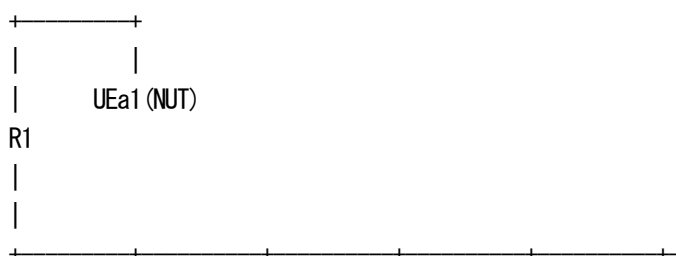

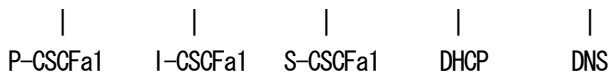

[INITIALIZATION]

Set up IP Address using A or B.

A. Router Advertisement

B. DHCPv6

(NUT)

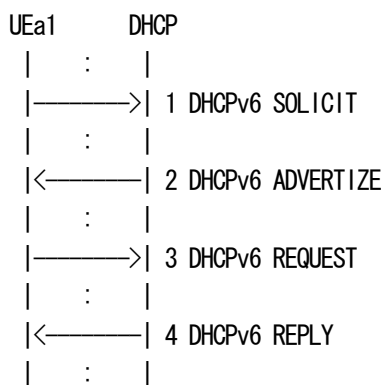

[PROCEDURE]

Home Network

(NUT)

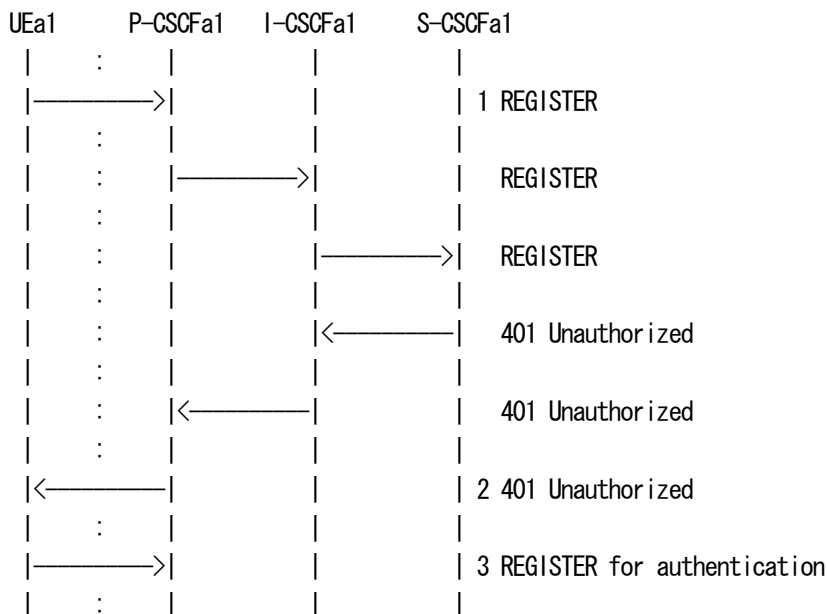

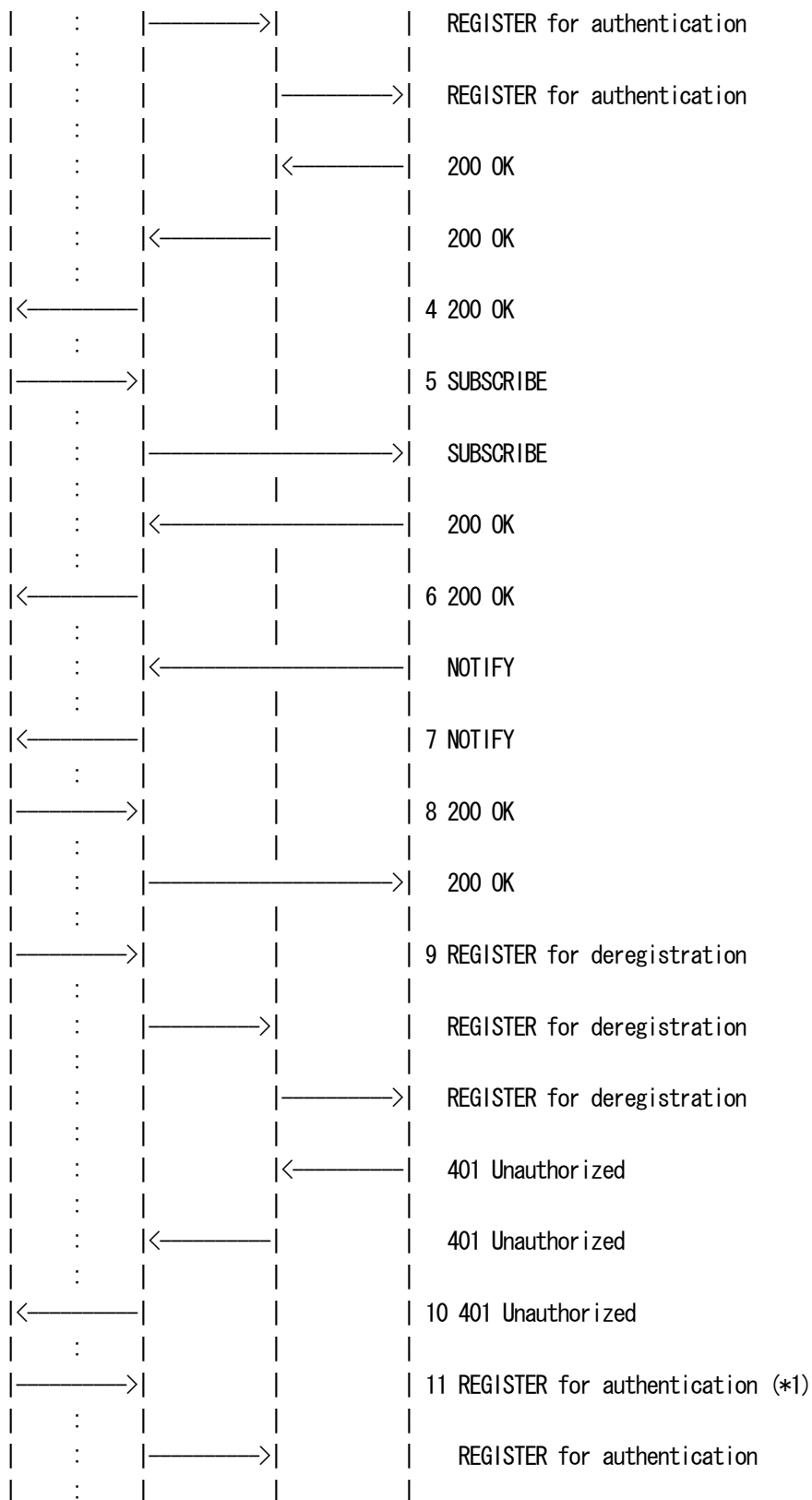



- 1 NUT sends REGISTER
- 2 NUT receives 401 Unauthorized
- 3 NUT sends REGISTER for authentication
- 4 NUT receives 200 OK
- 5 NUT sends SUBSCRIBE
- 6 NUT receives 200 OK
- 7 NUT receives NOTIFY
- 8 NUT sends 200 OK
- 9 NUT sends REGISTER for deregistration
- 10 NUT receives 401 Unauthorized
- 11 NUT sends REGISTER for authentication
- 12 NUT receives 200 OK

=== Message example ===

As regards the message 1-9, please refer to the message 1-9 in UE-RG-B-4-AKA.

10. 401 Unauthorized P-CSCF -> NUT

SIP/2.0 401 Unauthorized

Via: SIP/2.0/UDP [3ffe:501:ffff:1000::1000]:1357;branch=z9hG4bKnashds9

WWW-Authenticate: Digest realm="under.test.com",

nonce="J2U8vpY3qJhiuZNRke/ObponGSCcLm5iR+WCRkWYoM", algorithm=AKAv1-MD5

From: <sip:UEa1_public_1@under.test.com>;tag=4fa4

To: <sip:UEa1_public_1@under.test.com>;tag=5ef6

Call-ID: apb03a0s09dkjdfglkj49111@under.test.com

CSeq: 3 REGISTER

Security-Server: ipsec-3gpp; alg=hmac-sha-1-96; spi-c=266; spi-s=267; port-c=10004; port-s=10001

Content-Length: 0

11. REGISTER NUT -> P-CSCF

REGISTER sip:under.test.com SIP/2.0

Via: SIP/2.0/UDP [3ffe:501:ffff:1000::1000]:1357;branch=z9hG4bKnashds10

Max-Forwards: 70

From: <sip:UEa1_public_1@under.test.com>;tag=4fa4



To: <sip:UEa1_public_1@under.test.com>
Contact: <sip:UEa1_public_1@node.under.test.com:1357>;expires=0
Call-ID: apb03a0s09dkjdfglkj49111@under.test.com
Authorization: Digest username="UEa1_private@under.test.com", realm="under.test.com",
algorithm=AKAv1-MD5, nonce="J2U8vpY3qJhiuZNRke/ObponGSCcLm5iR+WCRkWyOM",
uri="sip:under.test.com", response="7729fae49393a05397450978507c4ef2"
Security-Client: ipsec-3gpp; mode="trans"; alg=hmac-sha-1-96; spi-c=33456789; spi-s=22345678;
port-c=3468; port-s=1357
Security-Verify: ipsec-3gpp; alg=hmac-sha-1-96; spi-c=266; spi-s=267; port-c=10004; port-s=10001
Supported: path
Require: sec-agree
Proxy-Require: sec-agree
CSeq: 4 REGISTER
Content-Length: 0

12. 200 OK P-CSCF -> NUT
SIP/2.0 200 OK
Via: SIP/2.0/UDP [3ffe:501:ffff:1000::1000]:1357;branch=z9hG4bKnashds10
From: <sip:UEa1_public_1@under.test.com>;tag=4fa4
To: <sip:UEa1_public_1@under.test.com>;tag=5ef7
Call-ID: apb03a0s09dkjdfglkj49111@under.test.com
Contact: <sip:UEa1_public_1@node.under.test.com:1357>;expires=0
Path: <sip:term@p.a1.under.test.com;lr>
Service-Route: <sip:orig@s.a1.under.test.com;lr>
CSeq: 4 REGISTER
P-Associated-URI: <sip:UEa1_public_1@under.test.com>
Date: Wed, 11 July 2001 08:49:37 GMT
Content-Length: 0

[OBSERVABLE RESULTS]

*1: 11 REGISTER for authentication from NUT to P-CSCF

See generic_Auth_REGISTER

Contact header field SHALL be set to the protected server port
value bound to the security association.[TS24229-5.1-318]

4.1.22 UE-RG-B-22-AKA - Reception of 503 response to subscription for the registration state event package



[NAME]

UE-RG-B-22-AKA - Reception of 503 response to subscription for the registration state event package

[TARGET]

IMS User Equipment (NUT)

[PURPOSE]

To verify that the UEa1 does not automatically reattempt the request until after the period indicated by the Retry-After header contents.

[REFERENCE]

TS24.229 5.1.2.2

[REQUIREMENT]

NONE

[PARAMETER(NUT)]

public-user-id : sip:UEa1_public_1@under.test.com
private-user-id : UEa1_private@under.test.com
contact_URI : sip:UEa1_public_1@node.under.test.com
HOMENETWORK Domain : sip:under.test.com

[PARAMETER(TESTER)]

P-CSCFa1 : sip:p.a1.under.test.com
S-CSCFa1 : sip:s.a1.under.test.com

[ADDRESS]

UEa1(NUT) : 3ffe:501:fff:1000::1000
Router(R1) : 3ffe:501:fff:1000::1
P-CSCFa1 : 3ffe:501:fff:100::10
I-CSCFa1 : 3ffe:501:fff:100::20
S-CSCFa1 : 3ffe:501:fff:100::30
DNS : 3ffe:501:fff:100::40
DHCP : 3ffe:501:fff:100::50



[TOPOLOGY]

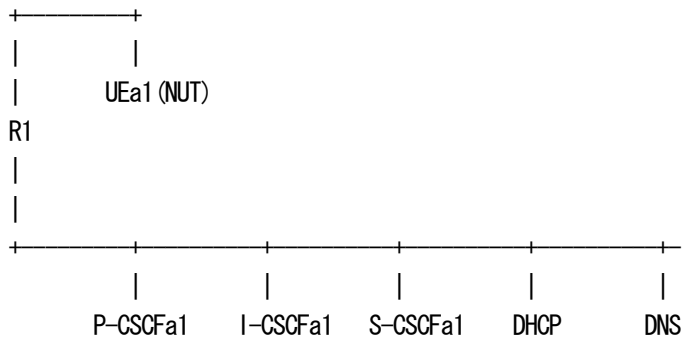

[INITIALIZATION]

Set up IP Address using A or B.

A. Router Advertisement

B. DHCPv6

(NUT)

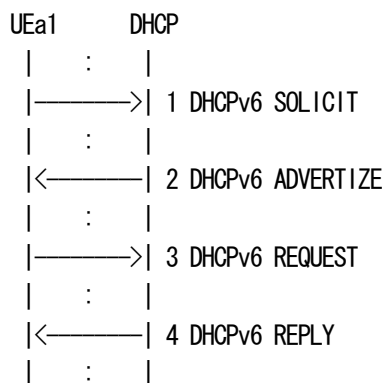

[PROCEDURE]

Home Network

(NUT)

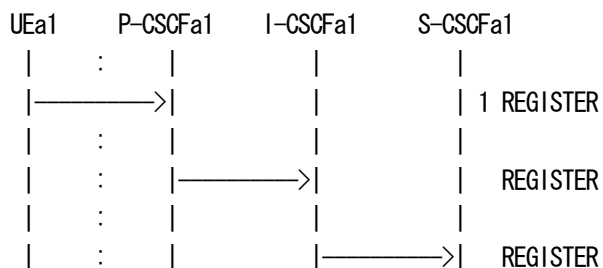

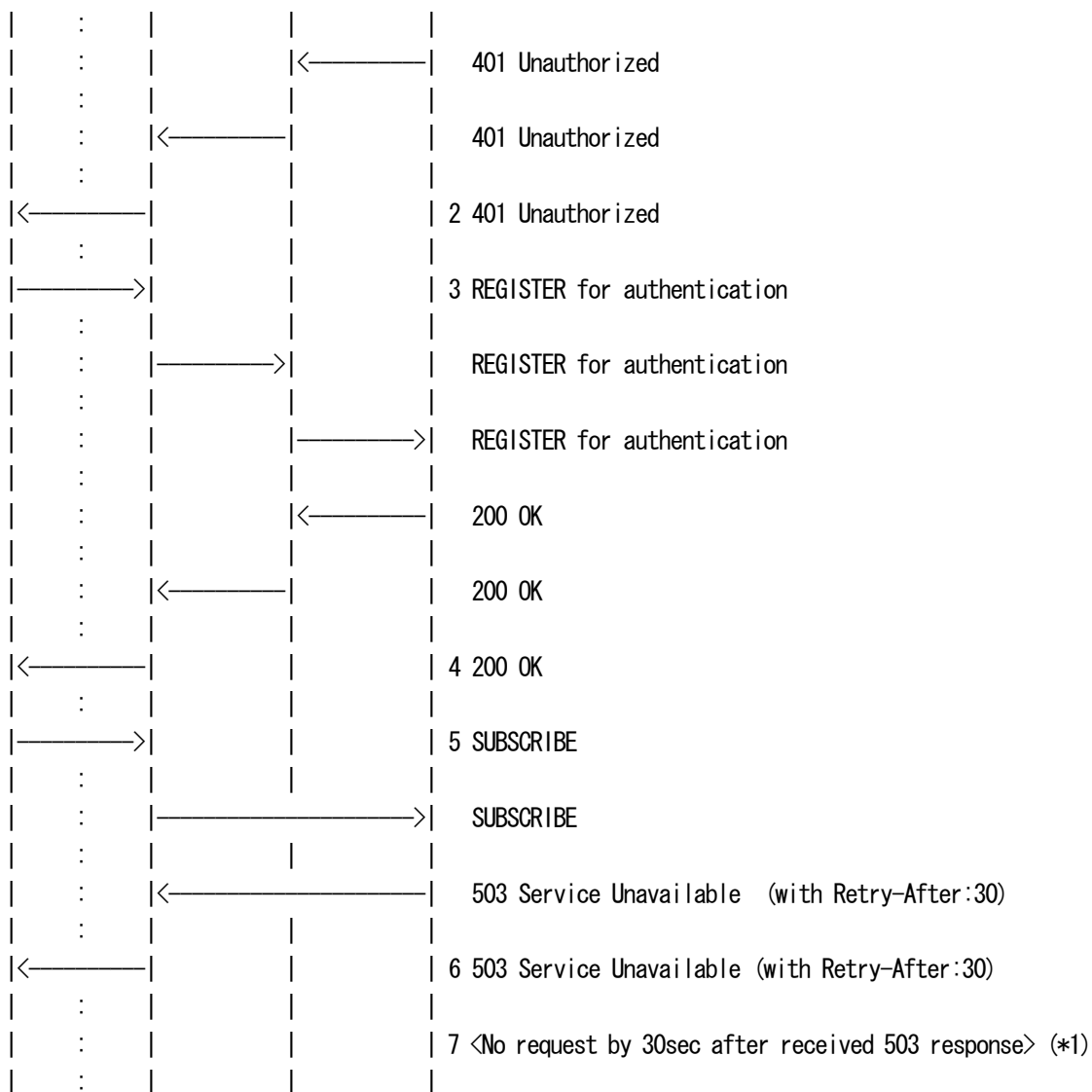

- 1 NUT sends REGISTER
- 2 NUT receives 401 Unauthorized
- 3 NUT sends REGISTER for authentication
- 4 NUT receives 200 OK
- 5 NUT sends SUBSCRIBE
- 6 NUT receives 503 Service Unavailable
- 7 <No request by 30sec after received 503 response>

=== Message example ===

As regards the message 1-5, please refer to the message 1-5 in UE-RG-B-1-AKA.

6. 503 Service Unavailable P-CSCF -> NUT
SIP/2.0 503 Service Unavailable



Via: SIP/2.0/UDP [3ffe:501:ffff:1000::1000]:1357;branch=z9hG4bKnashdsa1
From: <sip:UEa1_public_1@under.test.com>;tag=31415
To: <sip:UEa1_public_1@under.test.com>;tag=151170
Call-ID: b89rjhnedlrfjflsj40a222@under.test.com
CSeq: 1 SUBSCRIBE
Retry-After: 30
Content-Length: 0

7. <No request by 30sec after received 503 response>

[OBSERVABLE RESULTS]

*1: 7 No request by 30sec after received 503 response

The request SHALL not be automatically sent until after the period indicated by the Retry-After header field.[TS24229-5.1-354]

The client SHOULD NOT attempt re-subscription until after the number of seconds specified by the "retry-after" parameter.[RFC3265-3.2-21]

4.1.23 UE-RG-B-23-AKA - Security association (DES-EDE3-CBC and HMAC-MD5-96)

[NAME]

UE-RG-B-23-AKA - Security association (DES-EDE3-CBC and HMAC-MD5-96)

[TARGET]

IMS User Equipment (NUT)

[PURPOSE]

(1) To verify that the UEa1 properly supports DES-EDE3-CBC encryption algorithm and HMAC-MD5-96 integrity algorithm.

[REFERENCE]

TS24.229 5.1.1.2.2

TS33.203 7.1

[REQUIREMENT]



NONE

[PARAMETER(NUT)]

public-user-id : sip:UEa1_public_1@under.test.com
private-user-id : UEa1_private@under.test.com
contact_URI : sip:UEa1_public_1@node.under.test.com
HOMENETWORK Domain : sip:under.test.com

[PARAMETER(TESTER)]

P-CSCFa1 : sip:p.a1.under.test.com
S-CSCFa1 : sip:s.a1.under.test.com

[ADDRESS]

UEa1(NUT) : 3ffe:501:fff:1000::1000
Router(R1) : 3ffe:501:fff:1000::1
P-CSCFa1 : 3ffe:501:fff:100::10
I-CSCFa1 : 3ffe:501:fff:100::20
S-CSCFa1 : 3ffe:501:fff:100::30
DNS : 3ffe:501:fff:100::40
DHCP : 3ffe:501:fff:100::50

[TOPOLOGY]

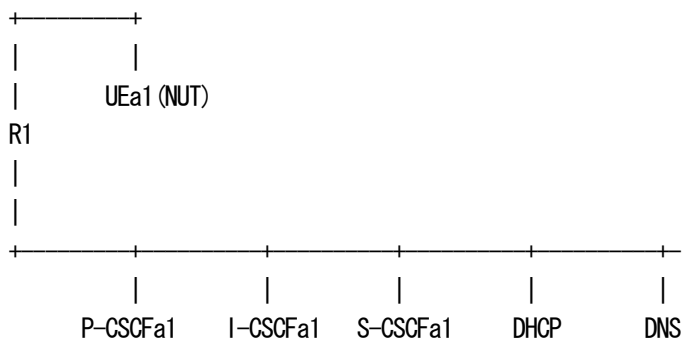

[INITIALIZATION]

Set up IP Address using A or B.

A. Router Advertisement

B. DHCPv6

(NUT)

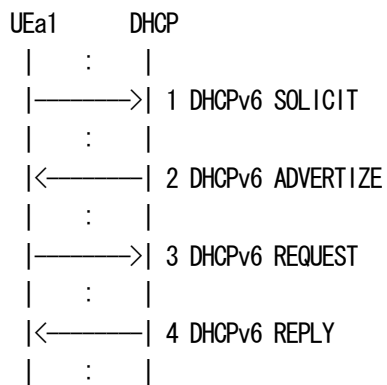

[PROCEDURE]

Home Network

(NUT)

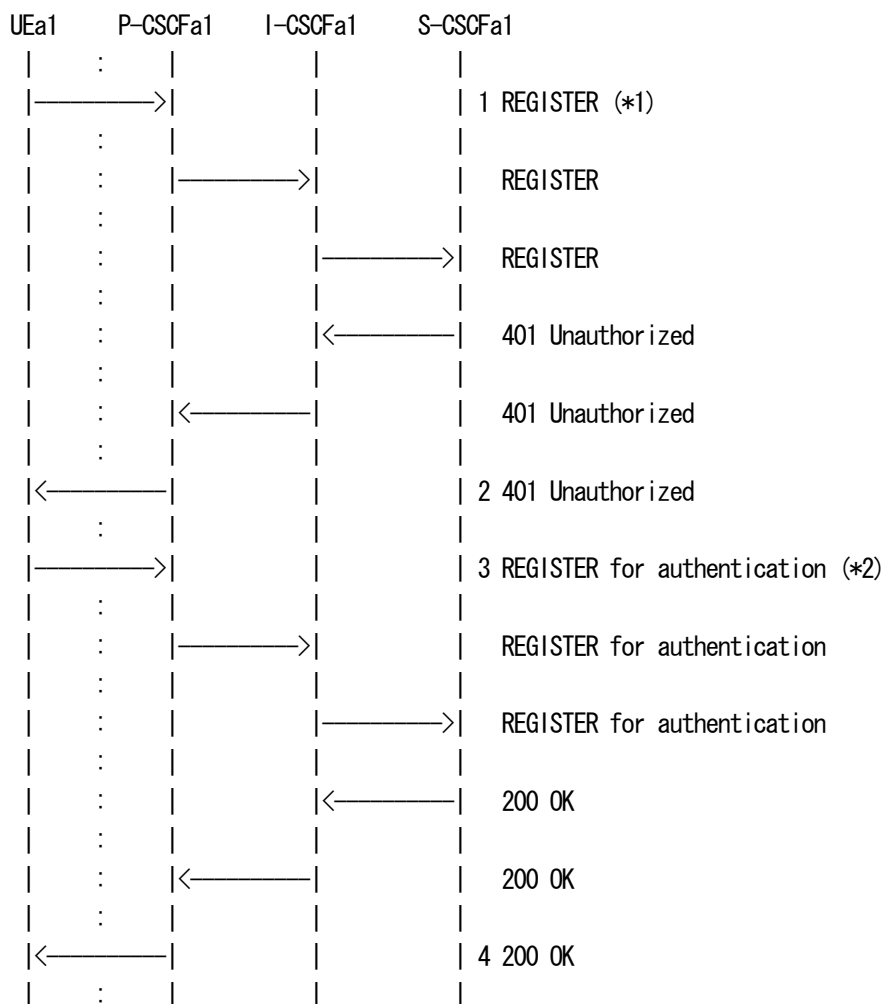

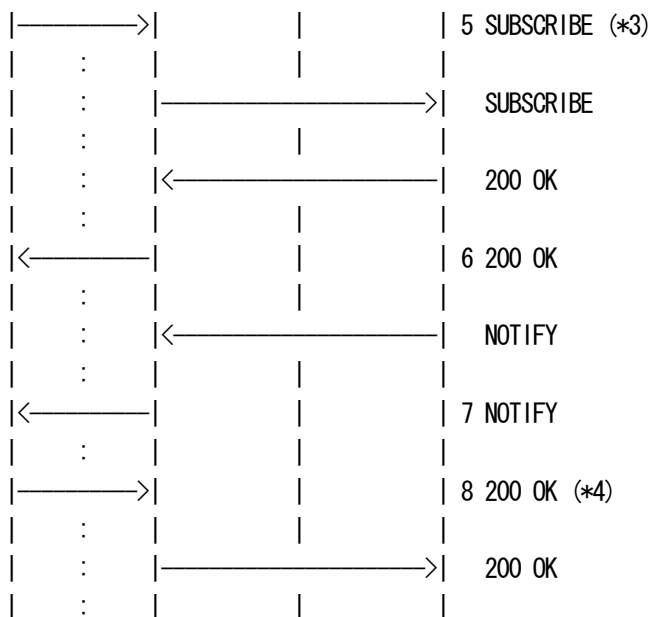

- 1 NUT sends REGISTER
- 2 NUT receives 401 Unauthorized
- 3 NUT sends REGISTER for authentication
- 4 NUT receives 200 OK
- 5 NUT sends SUBSCRIBE
- 6 NUT receives 200 OK
- 7 NUT receives NOTIFY
- 8 NUT sends 200 OK

=== Message example ===

1. REGISTER NUT -> P-CSCF
REGISTER sip:under.test.com SIP/2.0
Via: SIP/2.0/UDP [3ffe:501:ffff:1000::1000]:5060;branch=z9hG4bKnashds7
Max-Forwards: 70
From: <sip:UEa1_public_1@under.test.com>;tag=4fa3
To: <sip:UEa1_public_1@under.test.com>
Contact: <sip:UEa1_public_1@node.under.test.com>;expires=600000
Call-ID: apb03a0s09dkjdfgk49111@under.test.com
Authorization: Digest username="UEa1_private@under.test.com", realm="under.test.com", nonce="",
uri="sip:under.test.com", response=""
Security-Client: ipsec-3gpp; mode="trans"; alg= hmac-md5-96; ealg=des-ede3-cbc; spi-c=23456789;
spi-s=12345678; port-c=2468; port-s=1357
Require: sec-agree
Proxy-Require: sec-agree
CSeq: 1 REGISTER



Supported: path
Content-Length: 0

2. 401 Unauthorized P-CSCF -> NUT

SIP/2.0 401 Unauthorized

Via: SIP/2.0/UDP [3ffe:501:ffff:1000::1000]:5060;branch=z9hG4bKnashds7

WWW-Authenticate: Digest realm="under.test.com",

nonce="11U8vpY3qJhiuZnrke/NaponGSCcLm5iR+WCRkWYoM", algorithm=AKAv1-MD5

From: <sip:UEa1_public_1@under.test.com>;tag=4fa3

To: <sip:UEa1_public_1@under.test.com>;tag=5ef4

Call-ID: apb03a0s09dkjdfglkj49111@under.test.com

Security-Server: ipsec-3gpp; alg=hmac-sha-1-96; ealg=des-ede3-cbc; spi-c=256; spi-s=257; port-c=10002;
port-s=10001

CSeq: 1 REGISTER

Content-Length: 0

3. REGISTER NUT -> P-CSCF

REGISTER sip:under.test.com SIP/2.0

Via: SIP/2.0/UDP [3ffe:501:ffff:1000::1000]:1357;branch=z9hG4bKnashds8

Max-Forwards: 70

From: <sip:UEa1_public_1@under.test.com>;tag=4fa3

To: <sip:UEa1_public_1@under.test.com>

Contact: <sip:UEa1_public_1@node.under.test.com:1357>;expires=600000

Call-ID: apb03a0s09dkjdfglkj49111@under.test.com

Authorization: Digest username="UEa1_private@under.test.com", realm="under.test.com",
algorithm=AKAv1-MD5, nonce="11U8vpY3qJhiuZnrke/NaponGSCcLm5iR+WCRkWYoM",
uri="sip:under.test.com", response="6629fae49393a05397450978507c4ef1"

Security-Client: ipsec-3gpp; mode="trans"; alg=hmac-md5-96; ealg=des-ede3-cbc; spi-c=23456789;
spi-s=12345678; port-c=2468; port-s=1357

Security-Verify: ipsec-3gpp; alg=hmac-sha-1-96; ealg=des-ede3-cbc; spi-c=256; spi-s=257; port-c=10002;
port-s=10001

Require: sec-agree

Proxy-Require: sec-agree

CSeq: 2 REGISTER

Supported: path

Content-Length: 0

4. 200 OK P-CSCF -> NUT

SIP/2.0 200 OK

Via: SIP/2.0/UDP [3ffe:501:ffff:1000::1000]:1357;branch=z9hG4bKnashds8



From: <sip:UEa1_public_1@under.test.com>;tag=4fa3
To: <sip:UEa1_public_1@under.test.com>;tag=5ef5
Call-ID: apb03a0s09dkjdfglkj49111@under.test.com
Contact: <sip:UEa1_public_1@node.under.test.com:1357>;expires=600000
Path: <sip:term@p.a1.under.test.com;lr>
Service-Route: <sip:orig@s.a1.under.test.com;lr>
CSeq: 2 REGISTER
P-Associated-URI: <sip:UEa1_public_1@under.test.com>
Date: Wed, 11 July 2001 08:49:37 GMT
Content-Length: 0

5. SUBSCRIBE NUT -> P-CSCF

SUBSCRIBE sip:UEa1_public_1@under.test.com SIP/2.0
Via: SIP/2.0/UDP [3ffe:501:ffff:1000::1000]:1357;branch=z9hG4bKnashdsa1
Max-Forwards: 70
Route: <sip:p.a1.under.test.com:10001;lr>,<sip:orig@s.a1.under.test.com;lr>
From: <sip:UEa1_public_1@under.test.com>;tag=31415
To: <sip:UEa1_public_1@under.test.com>
Require: sec-agree
Proxy-Require: sec-agree
Call-ID: b89rjhnedlrfflsj40a222@under.test.com
CSeq: 1 SUBSCRIBE
Allow-Events: reg
Event: reg
Security-Verify: ipsec-3gpp; alg=hmac-sha-1-96; ealg=des-ede3-cbc; spi-c=256; spi-s=257; port-c=10002;
port-s=10001
Expires: 600000
Contact: <sip:UEa1_public_1@node.under.test.com:1357>
Content-Length: 0

6. 200 OK P-CSCF -> NUT

SIP/2.0 200 OK
Via: SIP/2.0/UDP [3ffe:501:ffff:1000::1000]:1357;branch=z9hG4bKnashdsa1
Record-Route: <sip:p.a1.under.test.com:10001;lr>
From: <sip:UEa1_public_1@under.test.com>;tag=31415
To: <sip:UEa1_public_1@under.test.com>;tag=151170
Call-ID: b89rjhnedlrfflsj40a222@under.test.com
CSeq: 1 SUBSCRIBE
Allow-Events: reg
Expires: 600000
Contact: <sip:s.a1.under.test.com>



Content-Length: 0

7. NOTIFY P-CSCF -> NUT

NOTIFY sip:UEa1_public_1@node.under.test.com:1357 SIP/2.0

Via: SIP/2.0/UDP p.a1.under.test.com:10001;branch=z9hG4bK240f34.1,

SIP/2.0/UDP s.a1.under.test.com;branch=z9hG4bK332b23.1;received=3ffe:501:ffff:100::30

Max-Forwards: 69

From: <sip:UEa1_public_1@under.test.com>;tag=151170

To: <sip:UEa1_public_1@under.test.com>;tag=31415

Call-ID: b89rjhnedlrfflsj40a222@under.test.com

CSeq: 1 NOTIFY

Contact: <sip:s.a1.under.test.com>

Subscription-State: active;expires=600000

Event: reg

Content-Type: application/reginfo+xml

Content-Length: (...)

```
<?xml version="1.0"?>
```

```
<reginfo xmlns="urn:ietf:params:xml:ns:reginfo" version="0" state="full">
```

```
  <registration aor="sip:UEa1_public_1@under.test.com" id="a7" state="active">
```

```
    <contact id="76" state="active" event="registered">
```

```
      <uri>sip:UEa1_public_1@node.under.test.com</uri>
```

```
    </contact>
```

```
  </registration>
```

```
</reginfo>
```

8. 200 OK NUT -> P-CSCF

SIP/2.0 200 OK

Via: SIP/2.0/UDP p.a1.under.test.com:10001;branch=z9hG4bK240f34.1;received=3ffe:501:ffff:100::10,

SIP/2.0/UDP s.a1.under.test.com;branch=z9hG4bK332b23.1;received=3ffe:501:ffff:100::30

From: <sip:UEa1_public_1@under.test.com>;tag=151170

To: <sip:UEa1_public_1@under.test.com>;tag=31415

Call-ID: b89rjhnedlrfflsj40a222@under.test.com

CSeq: 1 NOTIFY

Content-Length: 0

[OBSERVABLE RESULTS]

*1: 1 REGISTER from NUT to P-CSCF

See generic_REGISTER



*2: 3 REGISTER for authentication from NUT to P-CSCF

See generic_Auth_REGISTER

- Security behavior:

ESP confidentiality SHALL be used in transport mode between UE and P-CSCF.

[TS33203-6.2-3]

ESP integrity SHALL be used in transport mode between UE and P-CSCF.

[TS33203-6.3-3]

The integrity and confidentiality of the REGISTER request for authentication and all following SIP messages SHALL be protected.

[TS33203-7.2-8]

*3: 5 SUBSCRIBE from NUT to P-CSCF

See generic_SUBSCRIBE

- Security behavior:

The integrity and confidentiality of the REGISTER request for authentication and all following SIP messages SHALL be protected.

[TS33203-7.2-8]

*4: 8 NOTIFY 200 OK from NUT to P-CSCF

See generic_200-NOTIFY

- Security behavior:

The integrity and confidentiality of the REGISTER request for authentication and all following SIP messages SHALL be protected.

[TS33203-7.2-8]

4.1.24 UE-RG-B-24-AKA - Security association (AES-CBC and HMAC-SHA-1-96)

[NAME]

UE-RG-B-24-AKA - Security association (AES-CBC and HMAC-SHA-1-96)

[TARGET]

IMS User Equipment (NUT)



[PURPOSE]

(1) To verify that the UEa1 properly supports AES-CBC encryption algorithm and HMAC-SHA-1-96 integrity algorithm.

[REFERENCE]

TS24.229 5.1.1.2.2

TS33.203 7.1

[REQUIREMENT]

NONE

[PARAMETER(NUT)]

public-user-id : sip:UEa1_public_1@under.test.com
private-user-id : UEa1_private@under.test.com
contact_URI : sip:UEa1_public_1@node.under.test.com
HOMENETWORK Domain : sip.under.test.com

[PARAMETER(TESTER)]

P-CSCFa1 : sip:p.a1.under.test.com
S-CSCFa1 : sip:s.a1.under.test.com

[ADDRESS]

UEa1(NUT) : 3ffe:501:fff:1000::1000
Router(R1) : 3ffe:501:fff:1000::1
P-CSCFa1 : 3ffe:501:fff:100::10
I-CSCFa1 : 3ffe:501:fff:100::20
S-CSCFa1 : 3ffe:501:fff:100::30
DNS : 3ffe:501:fff:100::40
DHCP : 3ffe:501:fff:100::50

[TOPOLOGY]

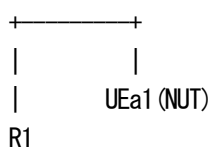

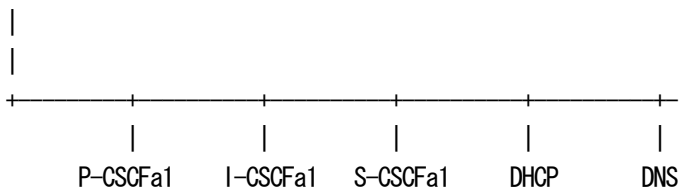

[INITIALIZATION]

Set up IP Address using A or B.

A. Router Advertisement

B. DHCPv6

(NUT)

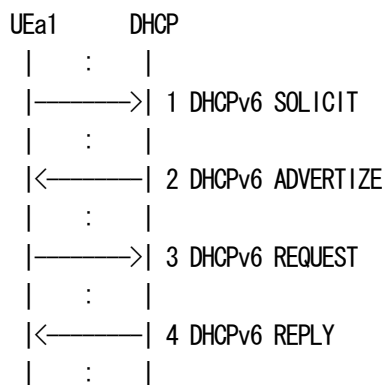

[PROCEDURE]

Home Network

(NUT)

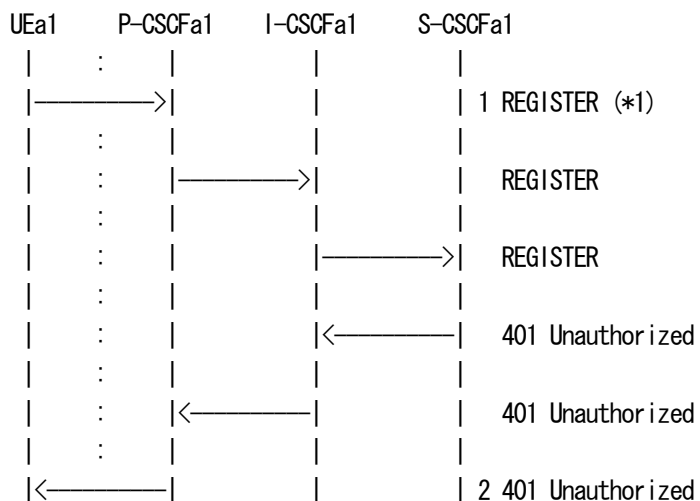

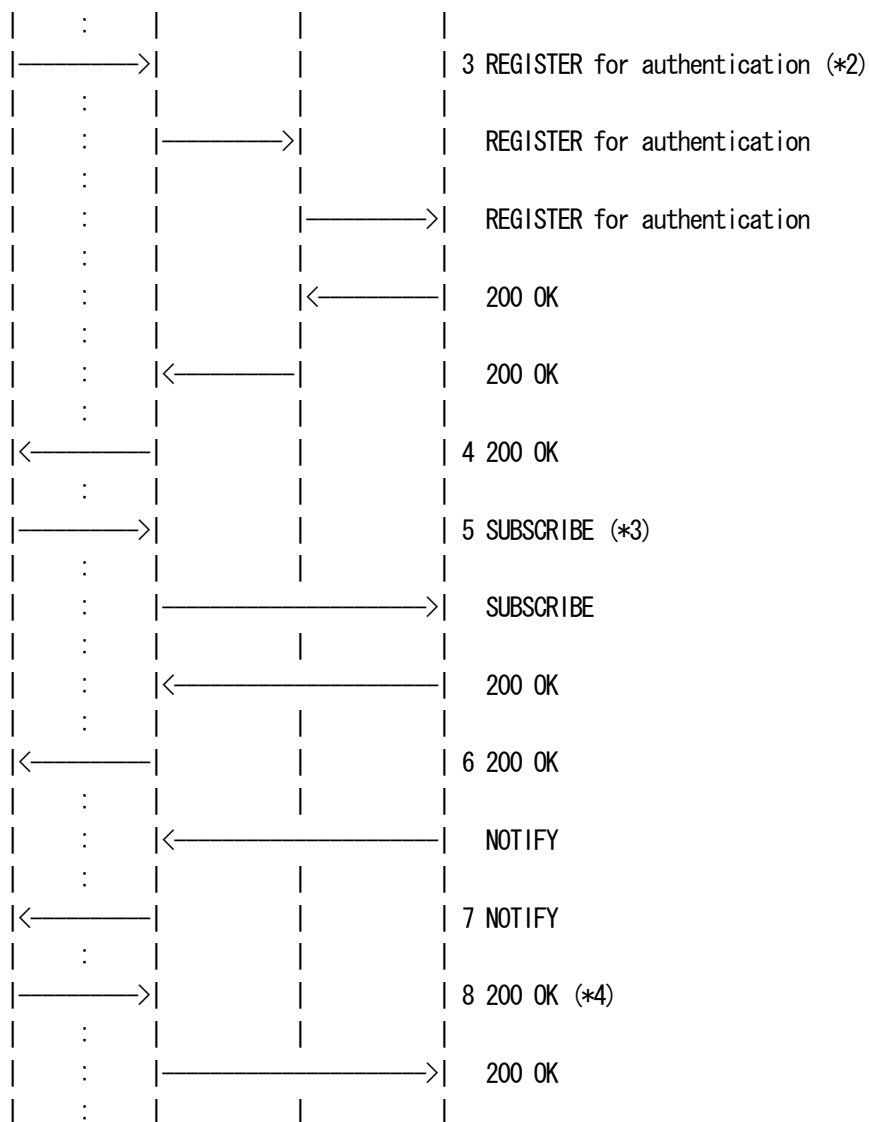

- 1 NUT sends REGISTER
- 2 NUT receives 401 Unauthorized
- 3 NUT sends REGISTER for authentication
- 4 NUT receives 200 OK
- 5 NUT sends SUBSCRIBE
- 6 NUT receives 200 OK
- 7 NUT receives NOTIFY
- 8 NUT sends 200 OK

=== Message example ===

1. REGISTER NUT -> P-CSCF
 REGISTER sip:under.test.com SIP/2.0



Via: SIP/2.0/UDP [3ffe:501:ffff:1000::1000]:5060;branch=z9hG4bKnashds7
Max-Forwards: 70
From: <sip:UEa1_public_1@under.test.com>;tag=4fa3
To: <sip:UEa1_public_1@under.test.com>
Contact: <sip:UEa1_public_1@node.under.test.com>;expires=600000
Call-ID: apb03a0s09dkjdfglkj49111@under.test.com
Authorization: Digest username="UEa1_private@under.test.com", realm="under.test.com", nonce="", uri="sip:under.test.com", response=""
Security-Client: ipsec-3gpp; mode="trans"; alg=hmac-sha-1-96; ealg=aes-cbc; spi-c=23456789; spi-s=12345678; port-c=2468; port-s=1357
Require: sec-agree
Proxy-Require: sec-agree
CSeq: 1 REGISTER
Supported: path
Content-Length: 0

2. 401 Unauthorized P-CSCF -> NUT

SIP/2.0 401 Unauthorized
Via: SIP/2.0/UDP [3ffe:501:ffff:1000::1000]:5060;branch=z9hG4bKnashds7
WWW-Authenticate: Digest realm="under.test.com", nonce="11U8vpY3qJhiuZNrke/NaponGSCcLm5iR+WCRkWYoM", algorithm=AKAv1-MD5
From: <sip:UEa1_public_1@under.test.com>;tag=4fa3
To: <sip:UEa1_public_1@under.test.com>;tag=5ef4
Call-ID: apb03a0s09dkjdfglkj49111@under.test.com
Security-Server: ipsec-3gpp; alg=hmac-sha-1-96; ealg=aes-cbc; spi-c=256; spi-s=257; port-c=10002; port-s=10001
CSeq: 1 REGISTER
Content-Length: 0

3. REGISTER NUT -> P-CSCF

REGISTER sip:under.test.com SIP/2.0
Via: SIP/2.0/UDP [3ffe:501:ffff:1000::1000]:1357;branch=z9hG4bKnashds8
Max-Forwards: 70
From: <sip:UEa1_public_1@under.test.com>;tag=4fa3
To: <sip:UEa1_public_1@under.test.com>
Contact: <sip:UEa1_public_1@node.under.test.com:1357>;expires=600000
Call-ID: apb03a0s09dkjdfglkj49111@under.test.com
Authorization: Digest username="UEa1_private@under.test.com", realm="under.test.com", algorithm=AKAv1-MD5, nonce="11U8vpY3qJhiuZNrke/NaponGSCcLm5iR+WCRkWYoM", uri="sip:under.test.com", response="6629fae49393a05397450978507c4ef1"
Security-Client: ipsec-3gpp; mode="trans"; alg=hmac-sha-1-96; ealg=aes-cbc; spi-c=23456789;



spi-s=12345678; port-c=2468; port-s=1357
Security-Verify: ipsec-3gpp; alg=hmac-sha-1-96; ealg=aes-cbc; spi-c=256; spi-s=257; port-c=10002;
port-s=10001
Require: sec-agree
Proxy-Require: sec-agree
CSeq: 2 REGISTER
Supported: path
Content-Length: 0

4. 200 OK P-CSCF -> NUT

SIP/2.0 200 OK
Via: SIP/2.0/UDP [3ffe:501:ffff:1000::1000]:1357;branch=z9hG4bKnashds8
From: <sip:UEa1_public_1@under.test.com>;tag=4fa3
To: <sip:UEa1_public_1@under.test.com>;tag=5ef5
Call-ID: apb03a0s09dkjdfglkj49111@under.test.com
Contact: <sip:UEa1_public_1@node.under.test.com:1357>;expires=600000
Path: <sip:term@p.a1.under.test.com;lr>
Service-Route: <sip:orig@s.a1.under.test.com;lr>
CSeq: 2 REGISTER
P-Associated-URI: <sip:UEa1_public_1@under.test.com>
Date: Wed, 11 July 2001 08:49:37 GMT
Content-Length: 0

5. SUBSCRIBE NUT -> P-CSCF

SUBSCRIBE sip:UEa1_public_1@under.test.com SIP/2.0
Via: SIP/2.0/UDP [3ffe:501:ffff:1000::1000]:1357;branch=z9hG4bKnashdsa1
Max-Forwards: 70
Route: <sip:p.a1.under.test.com:10001;lr>,<sip:orig@s.a1.under.test.com;lr>
From: <sip:UEa1_public_1@under.test.com>;tag=31415
To: <sip:UEa1_public_1@under.test.com>
Require: sec-agree
Proxy-Require: sec-agree
Call-ID: b89rjhnedlrfflsj40a222@under.test.com
CSeq: 1 SUBSCRIBE
Allow-Events: reg
Event: reg
Security-Verify: ipsec-3gpp; alg=hmac-sha-1-96; ealg=aes-cbc; spi-c=256; spi-s=257; port-c=10002;
port-s=10001
Expires: 600000
Contact: <sip:UEa1_public_1@node.under.test.com:1357>
Content-Length: 0



6. 200 OK P-CSCF -> NUT
SIP/2.0 200 OK
Via: SIP/2.0/UDP [3ffe:501:ffff:1000::1000]:1357;branch=z9hG4bKnashdsa1
Record-Route: <sip:p.a1.under.test.com:10001;lr>
From: <sip:UEa1_public_1@under.test.com>;tag=31415
To: <sip:UEa1_public_1@under.test.com>;tag=151170
Call-ID: b89rjhnedlrffflslj40a222@under.test.com
CSeq: 1 SUBSCRIBE
Allow-Events: reg
Expires: 600000
Contact: <sip:s.a1.under.test.com>
Content-Length: 0

7. NOTIFY P-CSCF -> NUT
NOTIFY sip:UEa1_public_1@node.under.test.com:1357 SIP/2.0
Via: SIP/2.0/UDP p.a1.under.test.com:10001;branch=z9hG4bK240f34.1,
SIP/2.0/UDP s.a1.under.test.com;branch=z9hG4bK332b23.1;received=3ffe:501:ffff:100::30
Max-Forwards: 69
From: <sip:UEa1_public_1@under.test.com>;tag=151170
To: <sip:UEa1_public_1@under.test.com>;tag=31415
Call-ID: b89rjhnedlrffflslj40a222@under.test.com
CSeq: 1 NOTIFY
Contact: <sip:s.a1.under.test.com>
Subscription-State: active;expires=600000
Event: reg
Content-Type: application/reginfo+xml
Content-Length: (...)

```
<?xml version="1.0"?>
<reginfo xmlns="urn:ietf:params:xml:ns:reginfo" version="0" state="full">
  <registration aor="sip:UEa1_public_1@under.test.com" id="a7" state="active">
    <contact id="76" state="active" event="registered">
      <uri>sip:UEa1_public_1@node.under.test.com</uri>
    </contact>
  </registration>
</reginfo>
```

8. 200 OK NUT -> P-CSCF
SIP/2.0 200 OK



Via: SIP/2.0/UDP p.a1.under.test.com:10001;branch=z9hG4bK240f34.1;received=3ffe:501:ffff:100::10,
SIP/2.0/UDP s.a1.under.test.com;branch=z9hG4bK332b23.1;received=3ffe:501:ffff:100::30
From: <sip:UEa1_public_1@under.test.com>;tag=151170
To: <sip:UEa1_public_1@under.test.com>;tag=31415
Call-ID: b89rjhnedlrffflslj40a222@under.test.com
CSeq: 1 NOTIFY
Content-Length: 0

[OBSERVABLE RESULTS]

*1: 1 REGISTER from NUT to P-CSCF

See generic_REGISTER

*2: 3 REGISTER for authentication from NUT to P-CSCF

See generic_Auth_REGISTER

- Security behavior:

ESP confidentiality SHALL be used in transport mode between UE and P-CSCF.[TS33203-6.2-3]

ESP integrity SHALL be used in transport mode between UE and P-CSCF. [TS33203-6.3-3]

The integrity and confidentiality of the REGISTER request for authentication and all following SIP messages SHALL be protected. [TS33203-7.2-8]

*3: 5 SUBSCRIBE from NUT to P-CSCF

See generic_SUBSCRIBE

- Security behavior:

The integrity and confidentiality of the REGISTER request for authentication and all following SIP messages SHALL be protected. [TS33203-7.2-8]

*4: 8 NOTIFY 200 OK from NUT to P-CSCF

See generic_200-NOTIFY

- Security behavior:

The integrity and confidentiality of the REGISTER request for authentication and all following SIP messages SHALL be protected.



[TS33203-7.2-8]

4.2 Session Establishment

4.2.1 UE-SE-B-1-AKA - Session initiation and termination (Sends INVITE and receives BYE)

[NAME]

UE-SE-B-1-AKA - Session initiation and termination (Sends INVITE and receives BYE)

[TARGET]

IMS User Equipment (NUT)

[PURPOSE]

(1) To verify that the UEa1 properly creates INVITE request and receives the responses relating INVITE request.

(2) To verify that the UEa1 properly receives BYE request and responds to BYE request.

[REFERENCE]

TS24.229 5.1.2A.1

TS24.229 5.1.2A.2

TS24.229 5.1.3.1

[REQUIREMENT]

NONE

[PARAMETER(NUT)]

public-user-id : sip:UEa1_public_1@under.test.com

private-user-id : UEa1_private@under.test.com

contact_URI : sip:UEa1_public_1@node.under.test.com

HOMENETWORK Domain : sip:under.test.com

[PARAMETER(TESTER)]



public-user-id(UEa2) : sip:UEa2_public_1@under.test.com
P-CSCFa1 : sip:p.a1.under.test.com

[ADDRESS]

UEa1(NUT) : 3ffe:501:ffff:1000::1000
Router(R1) : 3ffe:501:ffff:1000::1
P-CSCFa1 : 3ffe:501:ffff:100::10
I-CSCFa1 : 3ffe:501:ffff:100::20
S-CSCFa1 : 3ffe:501:ffff:100::30
DNS : 3ffe:501:ffff:100::40
DHCP : 3ffe:501:ffff:100::50

UEa2 : 3ffe:501:ffff:2000::1000
P-CSCFa2 : 3ffe:501:ffff:200::10
I-CSCFa2 : 3ffe:501:ffff:200::20
S-CSCFa2 : 3ffe:501:ffff:200::30

[TOPOLOGY]

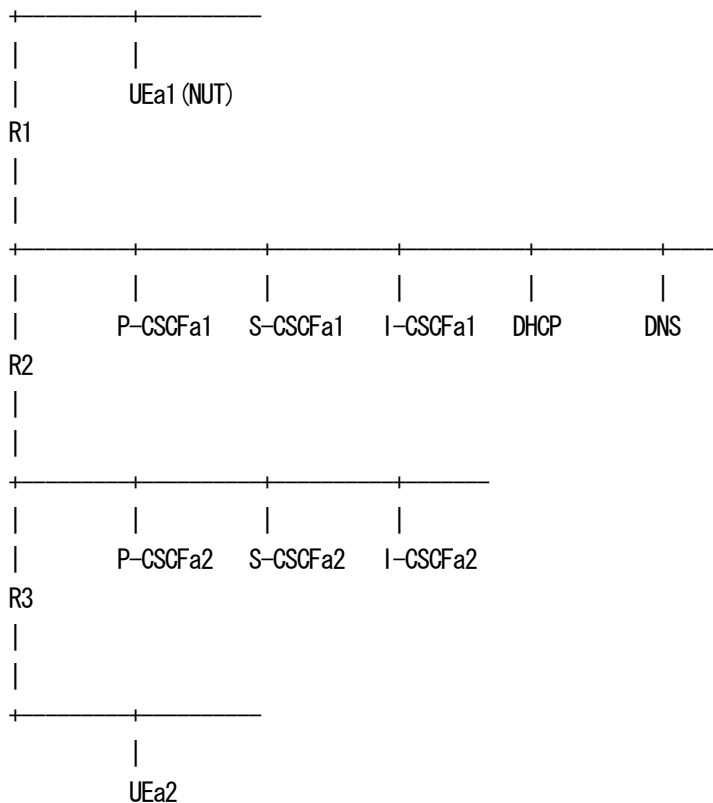



[INITIALIZATION]

UEa1(NUT) must be registered with the tester by executing the scenario "UE-INI-B-1-AKA".

For details of "UE-INI-B-1-AKA", refer to the profile "UE-RG-B-1-AKA".

[PROCEDURE]

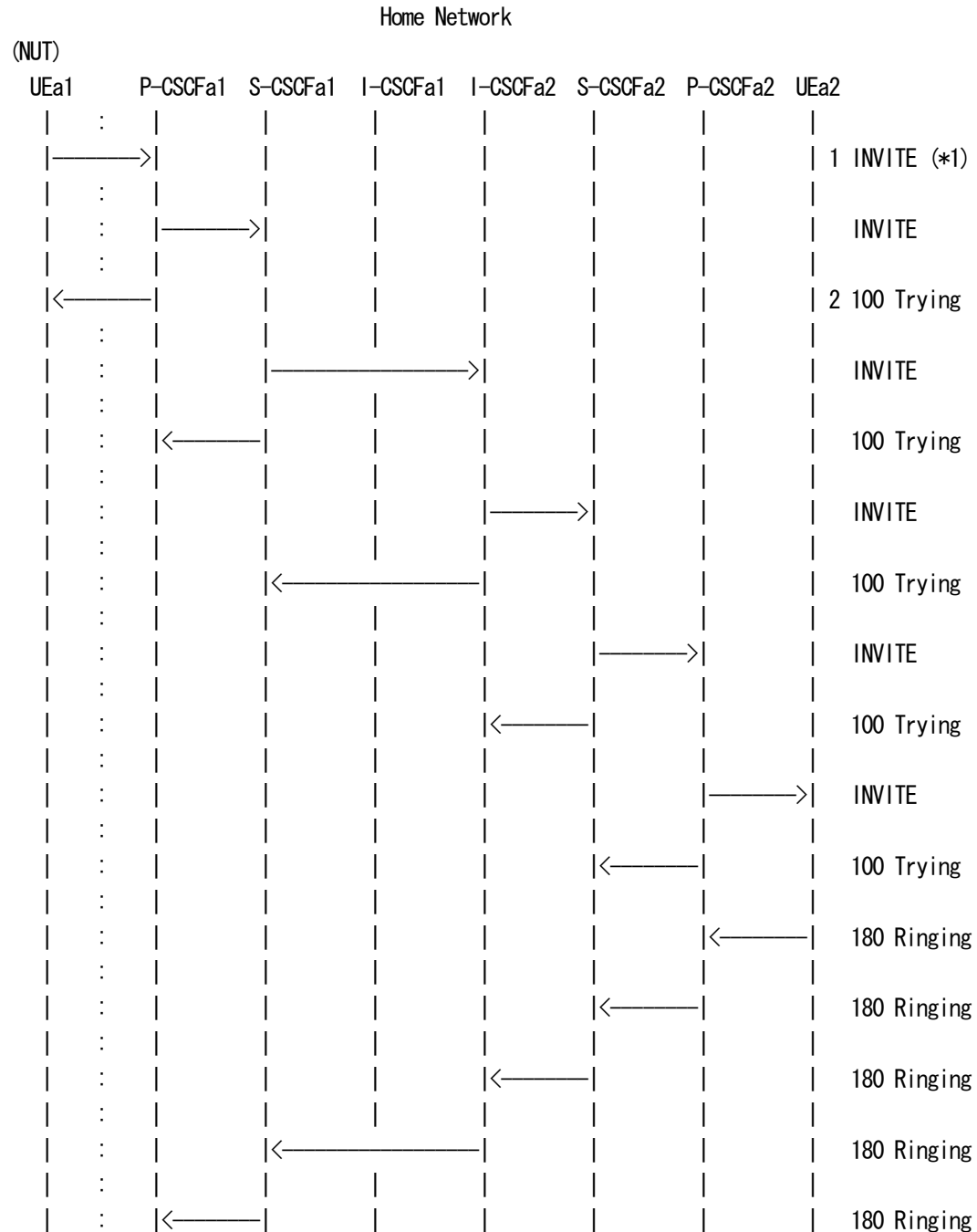

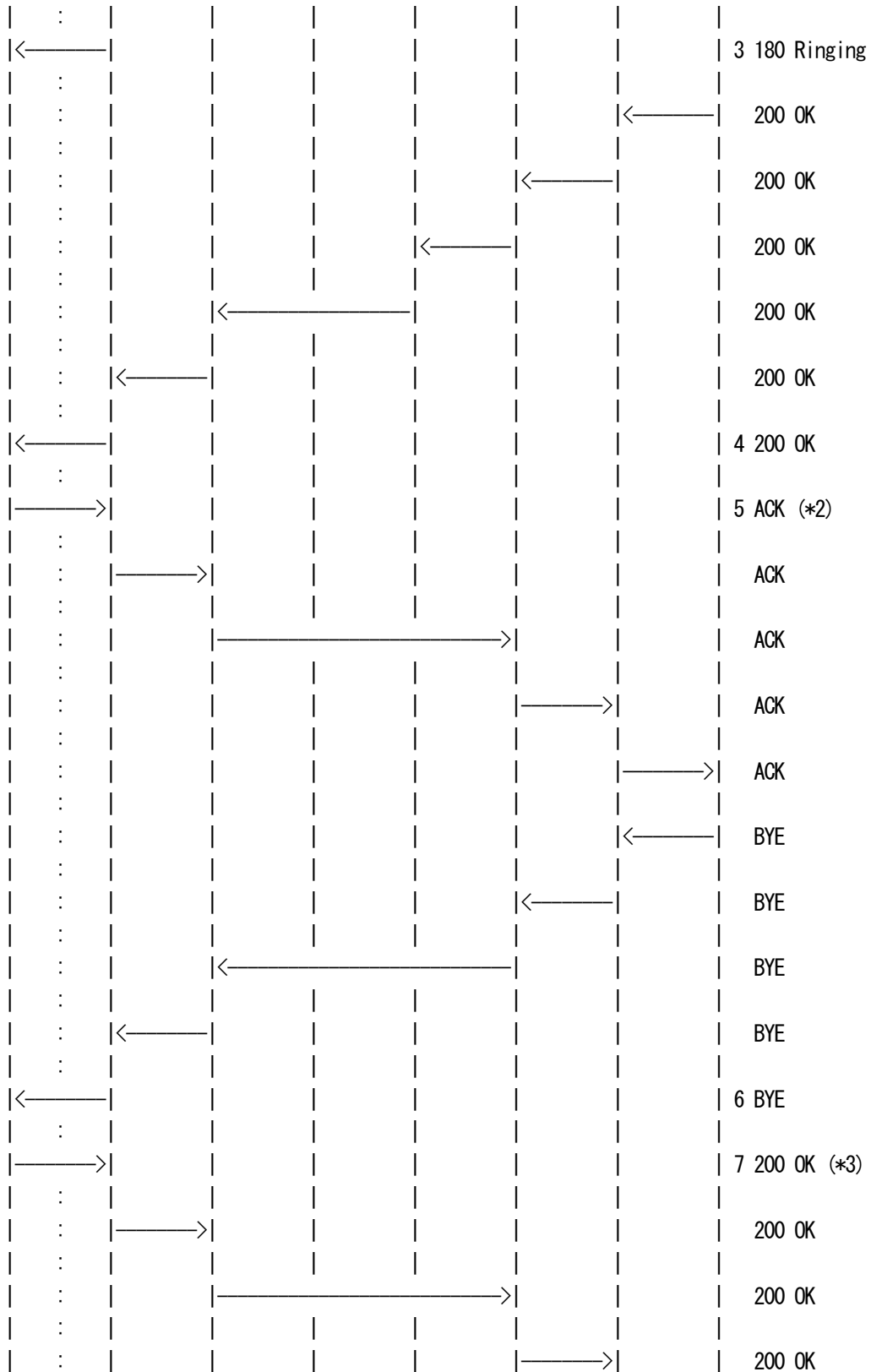



```
| : | | | | | | | |
| : | | | | | | | | |> 200 OK
| : | | | | | | | |
```

- 1 NUT sends INVITE
- 2 NUT receives 100 Trying
- 3 NUT receives 180 Ringing
- 4 NUT receives 200 OK
- 5 NUT sends ACK
- 6 NUT receives BYE
- 7 NUT sends 200 OK

=== Message example ===

1. INVITE NUT -> P-CSCF

INVITE sip:UEa2_public_1@under.test.com SIP/2.0

Via: SIP/2.0/UDP [3ffe:501:ffff:1000::1000]:1357;branch=z9hG4bK74bf9

Route: <sip:p.a1.under.test.com:10001;lr>,<sip:orig@s.a1.under.test.com;lr>

Max-Forwards: 70

From: <sip:UEa1_public_1@under.test.com>;tag=9fxced76sl

To: <sip:UEa2_public_1@under.test.com>

Call-ID: 3848276298220188511@under.test.com

CSeq: 1 INVITE

Contact: <sip:UEa1_public_1@node.under.test.com:1357>

Supported:

Allow: INVITE,ACK,CANCEL,OPTIONS,BYE

Allow-Events: reg

Accept: application/sdp,application/3gpp-ims+xml

Require: sec-agree

Proxy-Require: sec-agree

Security-Verify: ipsec-3gpp; alg=hmac-sha-1-96; spi-c=256; spi-s=257; port-c=10002; port-s=10001

Content-Type: application/sdp

Content-Length: 154

v=0

o=UEa1 2890844526 2890844526 IN IP6 node.under.test.com

s=-

c=IN IP6 node.under.test.com

t=0 0

m=audio 49172 RTP/AVP 0

b=AS:75

a=rtpmap:0 PCMU/8000



2. 100 Trying P-CSCF -> NUT

SIP/2.0 100 Trying

Via: SIP/2.0/UDP [3ffe:501:ffff:1000::1000]:1357;branch=z9hG4bK74bf9

From: <sip:UEa1_public_1@under.test.com>;tag=9fxced76sl

To: <sip:UEa2_public_1@under.test.com>

Call-ID: 3848276298220188511@under.test.com

CSeq: 1 INVITE

Content-Length: 0

3. 180 Ringing P-CSCF -> NUT

SIP/2.0 180 Ringing

Via: SIP/2.0/UDP [3ffe:501:ffff:1000::1000]:1357;branch=z9hG4bK74bf9

From: <sip:UEa1_public_1@under.test.com>;tag=9fxced76sl

To: <sip:UEa2_public_1@under.test.com>;tag=314259

Call-ID: 3848276298220188511@under.test.com

CSeq: 1 INVITE

Content-Length: 0

4. 200 OK P-CSCF -> NUT

SIP/2.0 200 OK

Via: SIP/2.0/UDP [3ffe:501:ffff:1000::1000]:1357;branch=z9hG4bK74bf9

Record-Route: <sip:p.a2.under.test.com;lr>,<sip:s.a2.under.test.com;lr>,<sip:s.a1.under.test.com;lr>,<sip:p.a1.under.test.com:10001;lr>

From: <sip:UEa1_public_1@under.test.com>;tag=9fxced76sl

To: <sip:UEa2_public_1@under.test.com>;tag=314259

Call-ID: 3848276298220188511@under.test.com

CSeq: 1 INVITE

Contact: <sip:UEa2_public_1@nodea2.under.test.com:22222>

Supported:

Allow: INVITE,ACK,CANCEL,OPTIONS,BYE

Allow-Events: reg

Content-Type: application/sdp

Content-Length: 153

v=0

o=UEa2 2890844527 2890844527 IN IP6 nodea2.under.test.com

s=-

c=IN IP6 nodea2.under.test.com

t=0 0

m=audio 3456 RTP/AVP 0



b=AS:75
a=rtpmap:0 PCMU/8000

5. ACK NUT -> P-CSCF

ACK sip:UEa2_public_1@nodea2.under.test.com:22222 SIP/2.0
Via: SIP/2.0/UDP [3ffe:501:ffff:1000::1000]:1357;branch=z9hG4bK74bf10
Route: <sip:p.a1.under.test.com:10001;lr>,<sip:s.a1.under.test.com;lr>,
<sip:s.a2.under.test.com;lr>,<sip:p.a2.under.test.com;lr>
Max-Forwards: 70
From: <sip:UEa1_public_1@under.test.com>;tag=9fxced76sl
To: <sip:UEa2_public_1@under.test.com>;tag=314259
Call-ID: 3848276298220188511@under.test.com
CSeq: 1 ACK
Content-Length: 0

6. BYE P-CSCF -> NUT

BYE sip:UEa1_public_1@node.under.test.com:1357 SIP/2.0
Via: SIP/2.0/UDP p.a1.under.test.com:10001;branch=z9hG4bK431e418c501,
SIP/2.0/UDP s.a1.under.test.com;branch=z9hG4bKnashdsa2.3;
received=3ffe:501:ffff:100::30,SIP/2.0/UDP s.a2.under.test.com;
branch=z9hG4bK721e418c9.1;received=3ffe:501:ffff:200::30,SIP/2.0/UDP
p.a2.under.test.com;branch=z9hG4bKnaghs30;received=3ffe:501:ffff:200::10,SIP/2.0/UDP
[3ffe:501:ffff:2000::1000]:22222;branch=z9hG4bKnashdsb3
Max-Forwards: 66
From: <sip:UEa2_public_1@under.test.com>;tag=314259
To: <sip:UEa1_public_1@under.test.com>;tag=9fxced76sl
Call-ID: 3848276298220188511@under.test.com
CSeq: 2 BYE
Content-Length: 0

7. 200 OK NUT -> P-CSCF

SIP/2.0 200 OK
Via: SIP/2.0/UDP p.a1.under.test.com:10001;branch=z9hG4bK431e418c501;
received=3ffe:501:ffff:100::10,SIP/2.0/UDP s.a1.under.test.com;
branch=z9hG4bKnashdsa2.3;received=3ffe:501:ffff:100::30,SIP/2.0/UDP
s.a2.under.test.com;branch=z9hG4bK721e418c9.1;
received=3ffe:501:ffff:200::30,SIP/2.0/UDP p.a2.under.test.com;
branch=z9hG4bKnaghs30;received=3ffe:501:ffff:200::10,SIP/2.0/UDP
[3ffe:501:ffff:2000::1000]:22222;branch=z9hG4bKnashdsb3
From: <sip:UEa2_public_1@under.test.com>;tag=314259



To: <sip:UEa1_public_1@under.test.com>;tag=9fxced76sl
Call-ID: 3848276298220188511@under.test.com
CSeq: 2 BYE
Content-Length: 0

[OBSERVABLE RESULTS]

*1: 1 INVITE from NUT to P-CSCF.

See generic_INVITE

*2: 5 ACK from NUT to P-CSCF

See generic_ACK

*3: 7 200 OK from NUT to P-CSCF

See generic_200-BYE

4.2.2 UE-SE-B-2-AKA - Session initiation and termination (Sends INVITE and sends BYE)

[NAME]

UE-SE-B-2-AKA - Session initiation and termination (Sends INVITE and sends BYE)

[TARGET]

IMS User Equipment (NUT)

[PURPOSE]

- (1) To verify that the UEa1 properly creates INVITE request and receives the responses relating to INVITE request.
- (2) To verify that the UEa1 properly creates BYE request and receives the responses to BYE request.

[REFERENCE]

TS24.229 5.1.2A.1

TS24.229 5.1.3.1



[REQUIREMENT]

NONE

[PARAMETER(NUT)]

public-user-id : sip:UEa1_public_1@under.test.com
private-user-id : UEa1_private@under.test.com
contact_URI : sip:UEa1_public_1@node.under.test.com
HOMENETWORK Domain : sip:under.test.com

[PARAMETER(TESTER)]

public-user-id(UEa2) : sip:UEa2_public_1@under.test.com
P-CSCFa1 : sip:p.a1.under.test.com

[ADDRESS]

UEa1(NUT) : 3ffe:501:fff:1000::1000
Router(R1) : 3ffe:501:fff:1000::1
P-CSCFa1 : 3ffe:501:fff:100::10
I-CSCFa1 : 3ffe:501:fff:100::20
S-CSCFa1 : 3ffe:501:fff:100::30
DNS : 3ffe:501:fff:100::40
DHCP : 3ffe:501:fff:100::50

UEa2 : 3ffe:501:fff:2000::1000
P-CSCFa2 : 3ffe:501:fff:200::10
I-CSCFa2 : 3ffe:501:fff:200::20
S-CSCFa2 : 3ffe:501:fff:200::30

[TOPOLOGY]

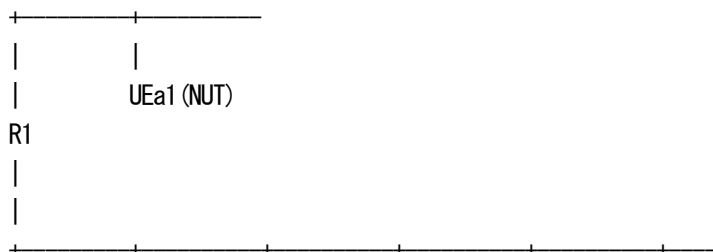

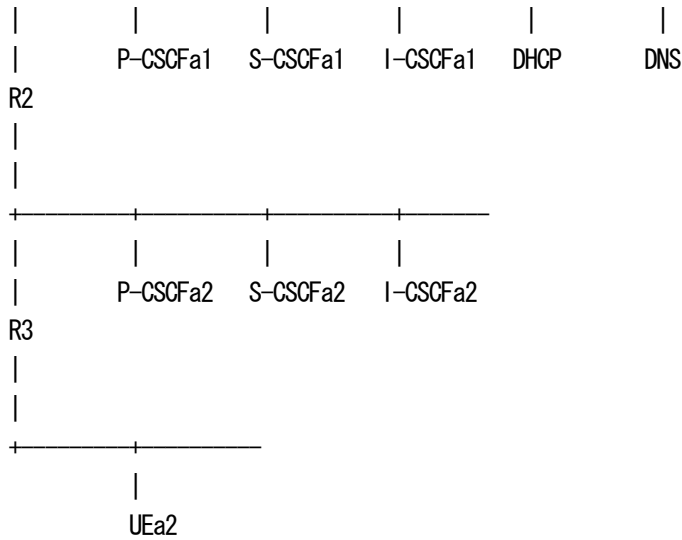

[INITIALIZATION]

UEa1(NUT) must be registered with the tester by executing the scenario "UE-INI-B-1-AKA".
 For details of "UE-INI-B-1-AKA", refer to the profile "UE-RG-B-1-AKA".

[PROCEDURE]

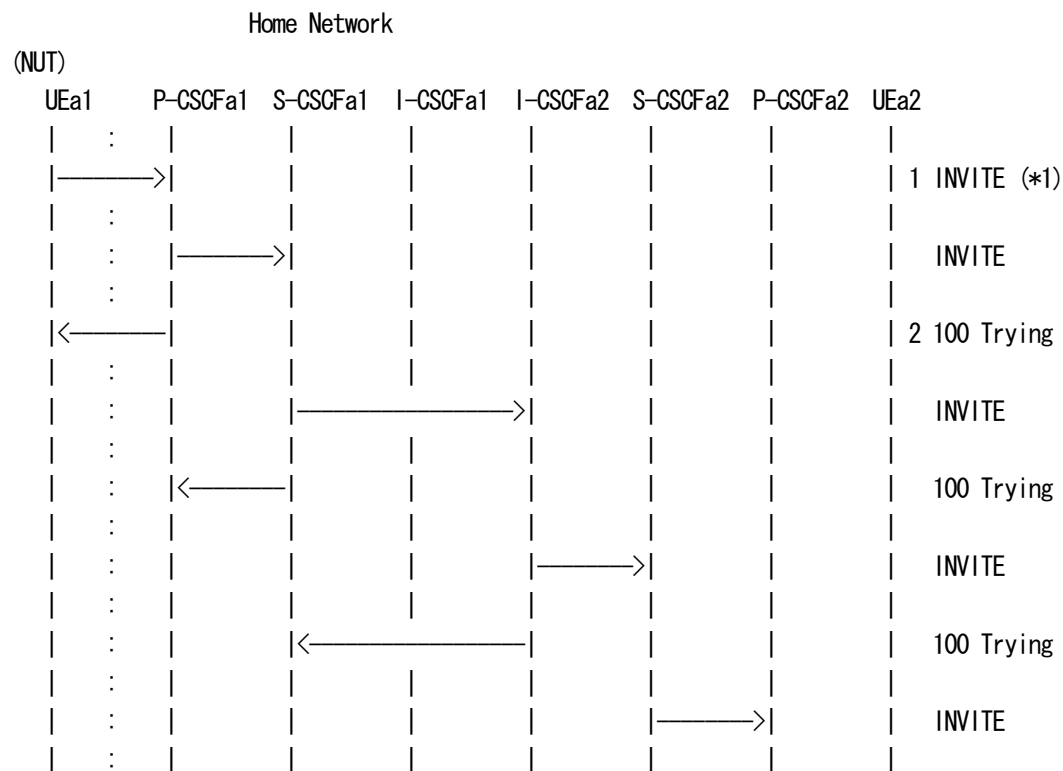

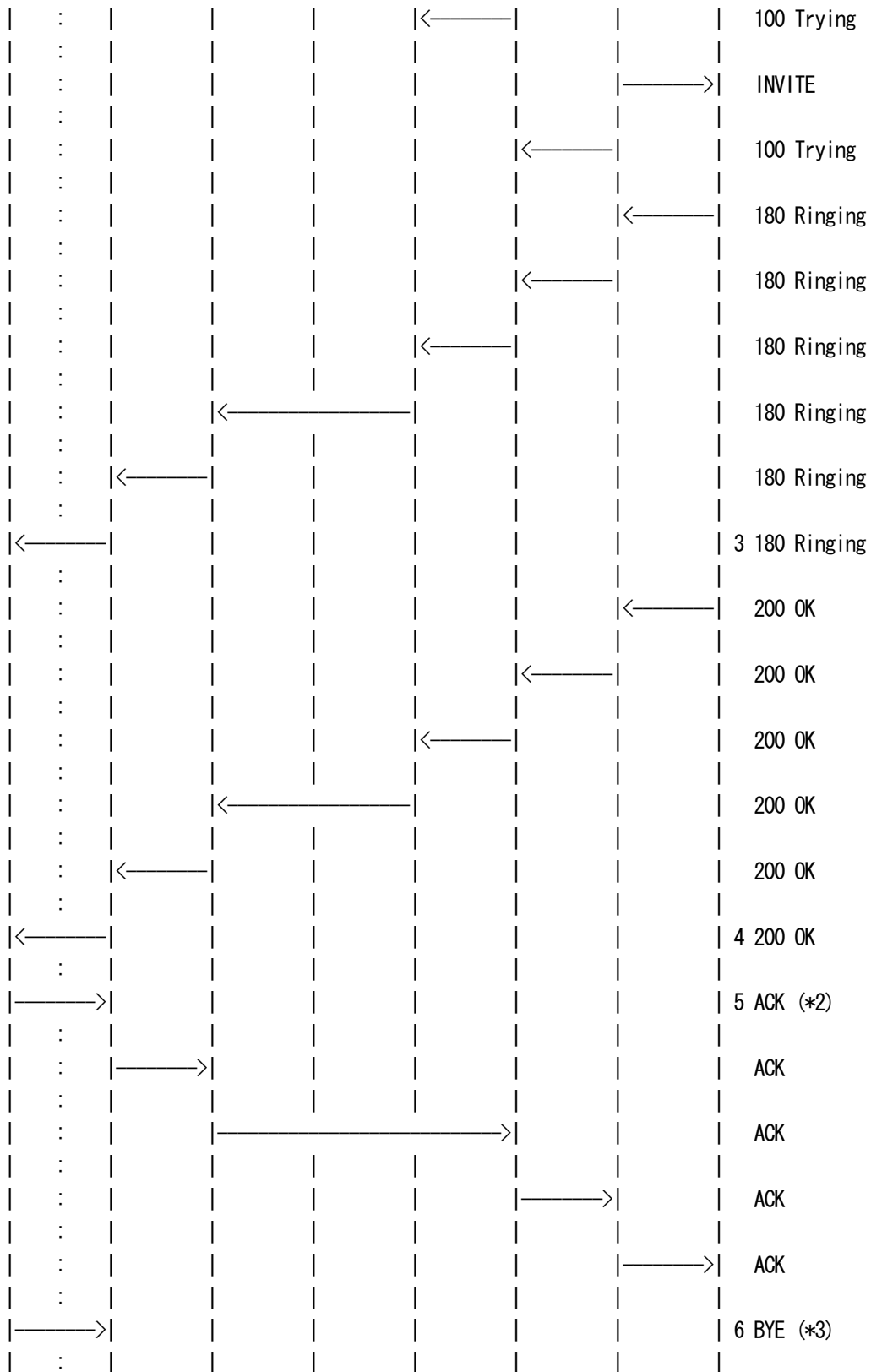

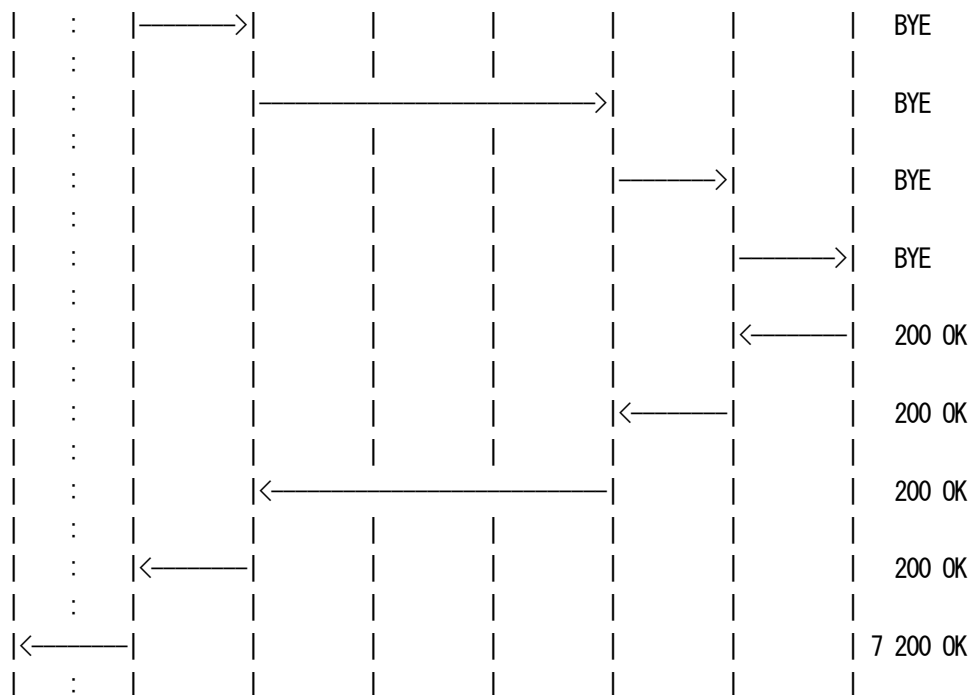

- 1 NUT sends INVITE
- 2 NUT receives 100 Trying
- 3 NUT receives 180 Ringing
- 4 NUT receives 200 OK
- 5 NUT sends ACK
- 6 NUT sends BYE
- 7 NUT receives 200 OK

=== Message example ===

1. INVITE NUT -> P-CSCF

```

INVITE sip:UEa2_public_1@under.test.com SIP/2.0
Via: SIP/2.0/UDP [3ffe:501:ffff:1000::1000]:1357;branch=z9hG4bK74bf9
Route: <sip:p.a1.under.test.com:10001;lr>,<sip:orig@s.a1.under.test.com;lr>
Max-Forwards: 70
From: <sip:UEa1_public_1@under.test.com>;tag=9fxced76sl
To: <sip:UEa2_public_1@under.test.com>
Call-ID: 3848276298220188511@under.test.com
CSeq: 1 INVITE
Contact: <sip:UEa1_public_1@node.under.test.com:1357>
Supported:
Allow: INVITE,ACK,CANCEL,OPTIONS,BYE
Allow-Events: reg
Accept: application/sdp,application/3gpp-ims+xml

```



Require: sec-agree
Proxy-Require: sec-agree
Security-Verify: ipsec-3gpp; alg=hmac-sha-1-96; spi-c=256; spi-s=257; port-c=10002; port-s=10001
Content-Type: application/sdp
Content-Length: 154

v=0
o=UEa1 2890844526 2890844526 IN IP6 node.under.test.com
s=-
c=IN IP6 node.under.test.com
t=0 0
m=audio 49172 RTP/AVP 0
b=AS:75
a=rtpmap:0 PCMU/8000

2. 100 Trying P-CSCF -> NUT

SIP/2.0 100 Trying
Via: SIP/2.0/UDP [3ffe:501:ffff:1000::1000]:1357;branch=z9hG4bK74bf9
From: <sip:UEa1_public_1@under.test.com>;tag=9fxced76sl
To: <sip:UEa2_public_1@under.test.com>
Call-ID: 3848276298220188511@under.test.com
CSeq: 1 INVITE
Content-Length: 0

3. 180 Ringing P-CSCF -> NUT

SIP/2.0 180 Ringing
Via: SIP/2.0/UDP [3ffe:501:ffff:1000::1000]:1357;branch=z9hG4bK74bf9
From: <sip:UEa1_public_1@under.test.com>;tag=9fxced76sl
To: <sip:UEa2_public_1@under.test.com>;tag=314259
Call-ID: 3848276298220188511@under.test.com
CSeq: 1 INVITE
Content-Length: 0

4. 200 OK P-CSCF -> NUT

SIP/2.0 200 OK
Via: SIP/2.0/UDP [3ffe:501:ffff:1000::1000]:1357;branch=z9hG4bK74bf9
Record-Route: <sip:p.a2.under.test.com;lr>,<sip:s.a2.under.test.com;lr>,
<sip:s.a1.under.test.com;lr>,<sip:p.a1.under.test.com:10001;lr>
From: <sip:UEa1_public_1@under.test.com>;tag=9fxced76sl
To: <sip:UEa2_public_1@under.test.com>;tag=314259



Call-ID: 3848276298220188511@under.test.com
CSeq: 1 INVITE
Contact: <sip:UEa2_public_1@nodea2.under.test.com:22222>
Supported:
Allow: INVITE,ACK,CANCEL,OPTIONS,BYE
Allow-Events: reg
Content-Type: application/sdp
Content-Length: 153

v=0
o=UEa2 2890844527 2890844527 IN IP6 nodea2.under.test.com
s=-
c=IN IP6 nodea2.under.test.com
t=0 0
m=audio 3456 RTP/AVP 0
b=AS:75
a=rtpmap:0 PCMU/8000

5. ACK NUT -> P-CSCF

ACK sip:UEa2_public_1@nodea2.under.test.com:22222 SIP/2.0
Via: SIP/2.0/UDP [3ffe:501:ffff:1000::1000]:1357;branch=z9hG4bK74bf10
Route: <sip:p.a1.under.test.com:10001;lr>,<sip:s.a1.under.test.com;lr>,
<sip:s.a2.under.test.com;lr>,<sip:p.a2.under.test.com;lr>
Max-Forwards: 70
From: <sip:UEa1_public_1@under.test.com>;tag=9fxced76sl
To: <sip:UEa2_public_1@under.test.com>;tag=314259
Call-ID: 3848276298220188511@under.test.com
CSeq: 1 ACK
Content-Length: 0

6. BYE NUT -> P-CSCF

BYE sip:UEa2_public_1@nodea2.under.test.com:22222 SIP/2.0
Via: SIP/2.0/UDP [3ffe:501:ffff:1000::1000]:1357;branch=z9hG4bK74bf11
Route: <sip:p.a1.under.test.com:10001;lr>,<sip:s.a1.under.test.com;lr>,
<sip:s.a2.under.test.com;lr>,<sip:p.a2.under.test.com;lr>
Max-Forwards: 70
From: <sip:UEa1_public_1@under.test.com>;tag=9fxced76sl
To: <sip:UEa2_public_1@under.test.com>;tag=314259
Call-ID: 3848276298220188511@under.test.com
CSeq: 2 BYE
Content-Length: 0



Security-Verify: ipsec-3gpp; alg=hmac-sha-1-96; spi-c=256; spi-s=257; port-c=10002; port-s=10001

Require: sec-agree

Proxy-Require: sec-agree

7. 200 OK P-CSCF -> NUT

SIP/2.0 200 OK

Via: SIP/2.0/UDP [3ffe:501:ffff:1000::1000]:1357;branch=z9hG4bK74bf11

From: <sip:UEa1_public_1@under.test.com>;tag=9fxced76sl

To: <sip:UEa2_public_1@under.test.com>;tag=314259

Call-ID: 3848276298220188511@under.test.com

CSeq: 2 BYE

Content-Length: 0

[OBSERVABLE RESULTS]

*1: 1 INVITE request from NUT to P-CSCF.

See generic_INVITE

*2: 5 ACK request from NUT to P-CSCF.

See generic_ACK

*3: 6 BYE request from NUT to P-CSCF.

See generic_BYE

4.2.3 UE-SE-B-3-AKA - Session initiation and termination (Receives INVITE and receives BYE)

[NAME]

UE-SE-B-3-AKA - Session initiation and termination (Receives INVITE and receives BYE)

[TARGET]

IMS User Equipment (NUT)

[PURPOSE]

(1) To verify that the UEa1 properly receives INVITE request and creates the



responses relating INVITE request.

(2) To verify that the UEa1 properly receives BYE request and responds to BYE request.

[REFERENCE]

TS24.229 5.1.2A.2

TS24.229 5.1.4.1

[REQUIREMENT]

NONE

[PARAMETER(NUT)]

public-user-id : sip:UEa1_public_1@under.test.com
private-user-id : UEa1_private@under.test.com
contact_URI : sip:UEa1_public_1@node.under.test.com
HOMENETWORK Domain : sip.under.test.com

[PARAMETER(TESTER)]

public-user-id(UEa2) : sip:UEa2_public_1@under.test.com
P-CSCFa1 : sip:p.a1.under.test.com

[ADDRESS]

UEa1(NUT) : 3ffe:501:fff:1000::1000
Router(R1) : 3ffe:501:fff:1000::1
P-CSCFa1 : 3ffe:501:fff:100::10
I-CSCFa1 : 3ffe:501:fff:100::20
S-CSCFa1 : 3ffe:501:fff:100::30
DNS : 3ffe:501:fff:100::40
DHCP : 3ffe:501:fff:100::50

UEa2 : 3ffe:501:fff:2000::1000
P-CSCFa2 : 3ffe:501:fff:200::10
I-CSCFa2 : 3ffe:501:fff:200::20
S-CSCFa2 : 3ffe:501:fff:200::30

[TOPOLOGY]

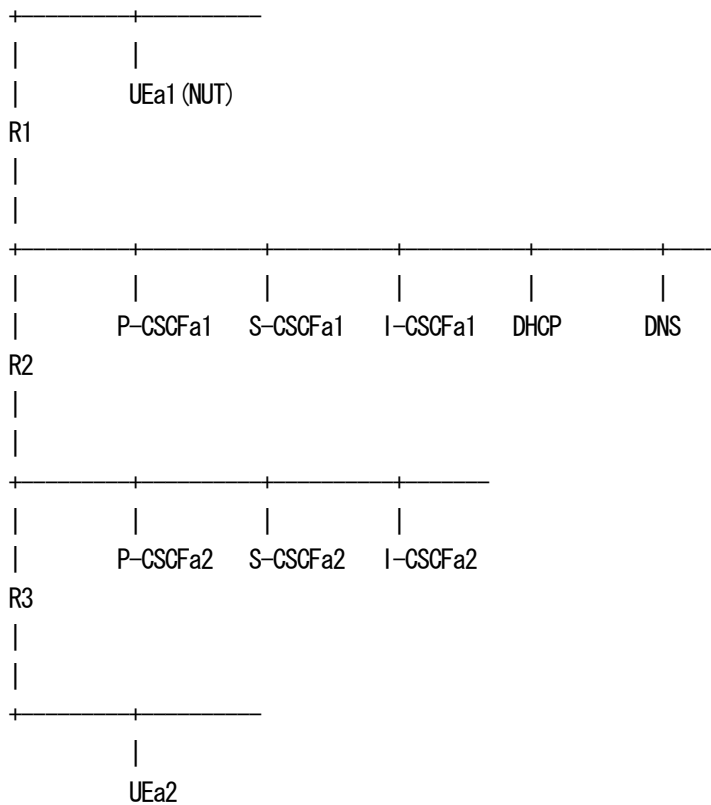

[INITIALIZATION]

UEa1(NUT) must be registered with the tester by executing the scenario "UE-INI-B-1-AKA".
 For details of "UE-INI-B-1-AKA", refer to the profile "UE-RG-B-1-AKA".

[PROCEDURE]

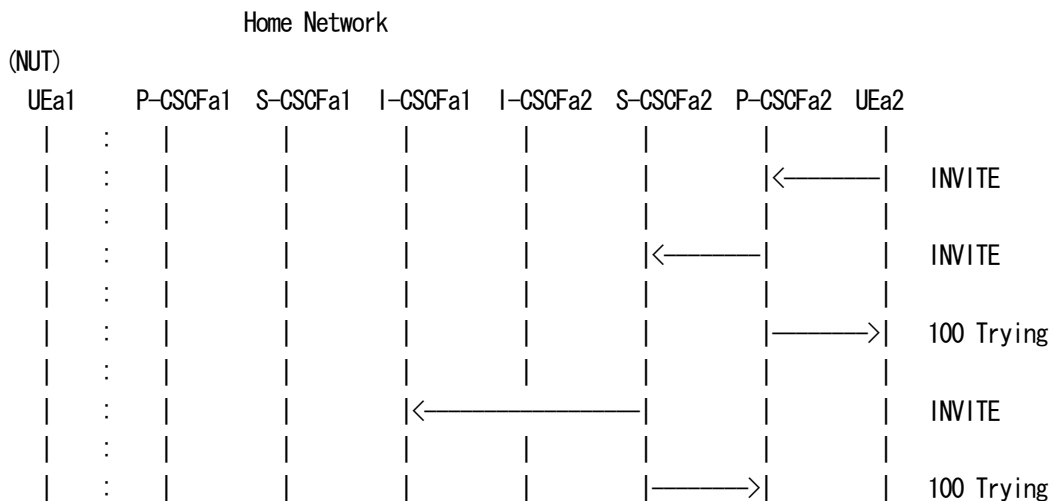

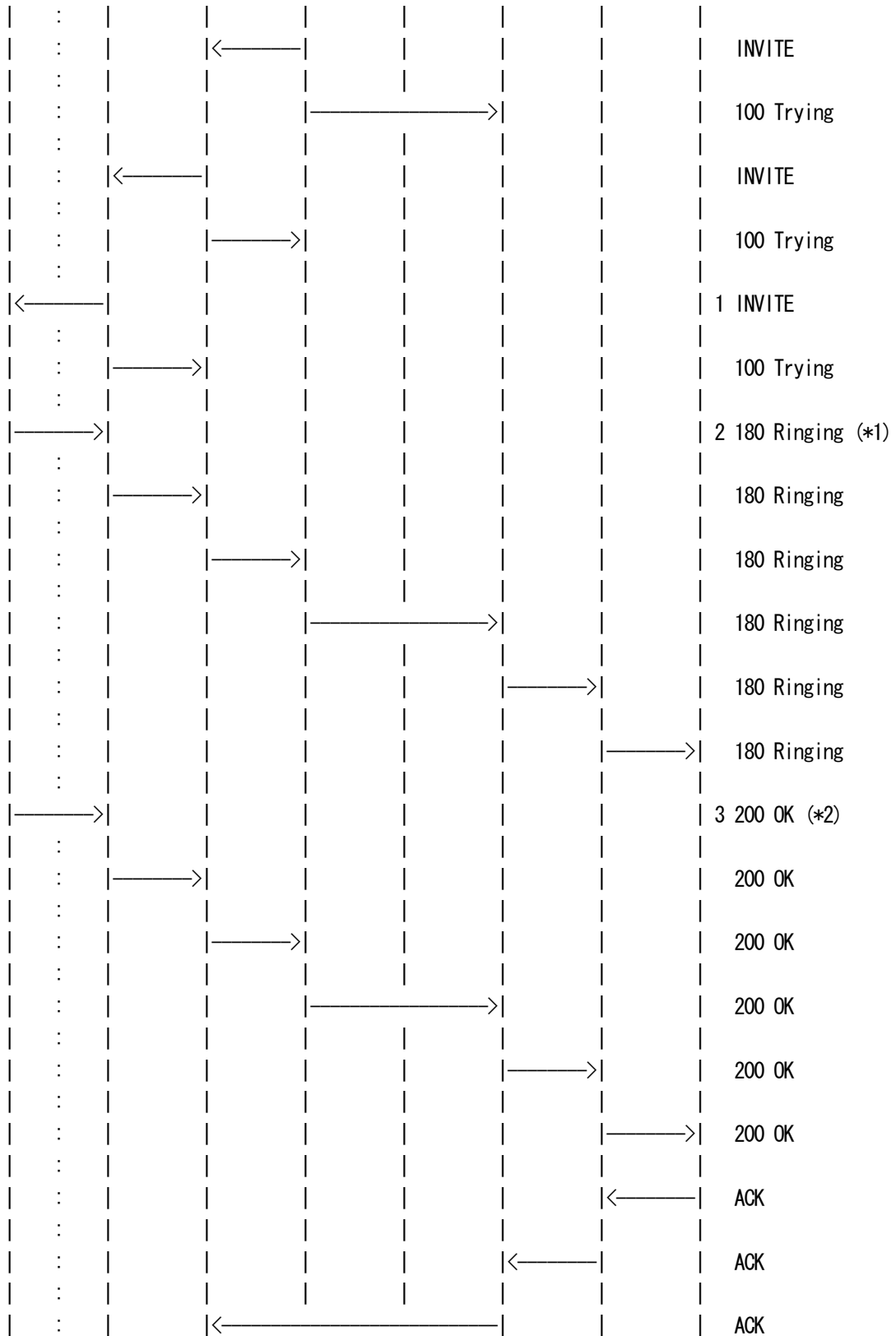

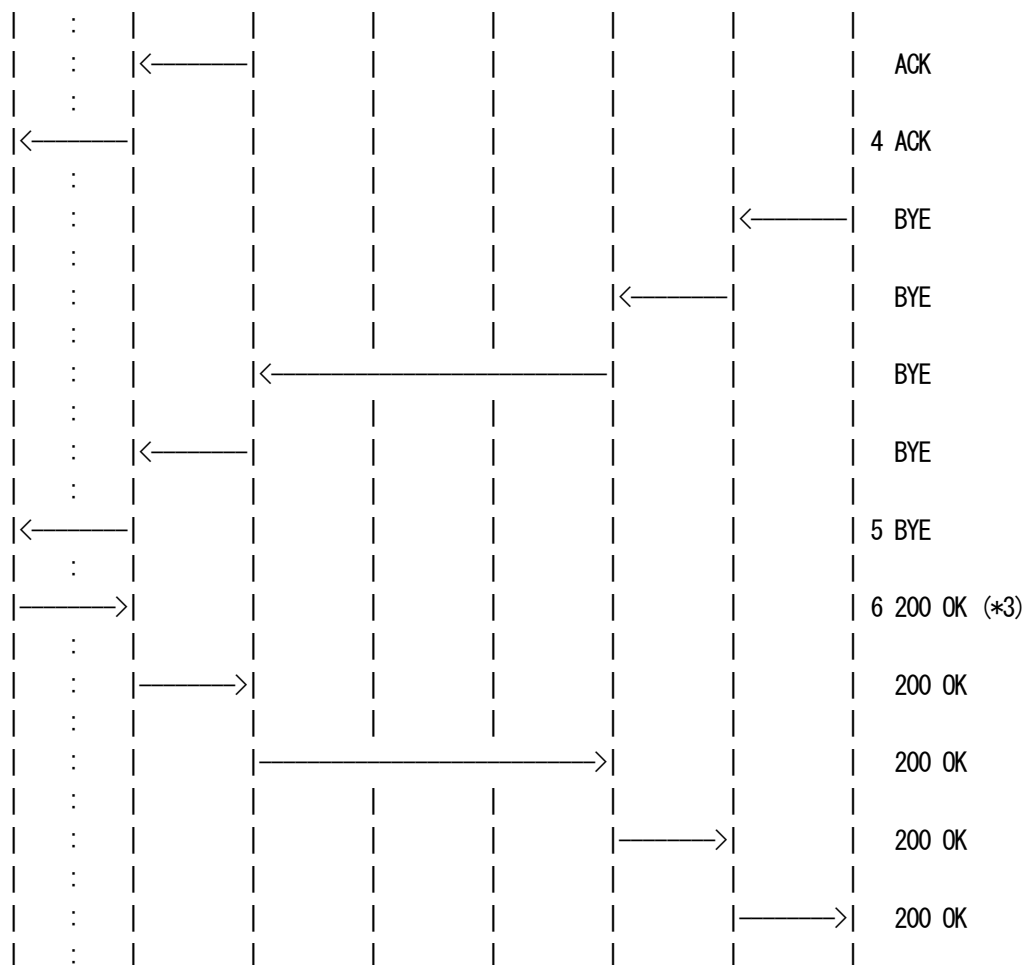

- 1 NUT receives INVITE
- 2 NUT sends 180 Ringing
- 3 NUT sends 200 OK
- 4 NUT receives ACK
- 5 NUT receives BYE
- 6 NUT sends 200 OK

=== Message example ===

1. INVITE P-CSCF -> NUT

INVITE sip:UEa1_public_1@node.under.test.com:1357 SIP/2.0

Via: SIP/2.0/UDP p.a1.under.test.com:10001;branch=z9hG4bK431e418c233,SIP/2.0/UDP
s.a1.under.test.com;branch=z9hG4bK431e418c4.2;received=3ffe:501:ffff:100::30,SIP/2.0/UDP
i.a1.under.test.com;branch=z9hG4bKnashds418c5a;received=3ffe:501:ffff:100::20,SIP/2.0/UDP
s.a2.under.test.com;branch=z9hG4bK721e418c657u;received=3ffe:501:ffff:200::30,SIP/2.0/UDP
p.a2.under.test.com;branch=z9hG4bKnaghc45ca8;received=3ffe:501:ffff:200::10,SIP/2.0/UDP
[3ffe:501:ffff:2000::1000];22222;branch=z9hG4bKnashds45ba91



Record-Route: <sip:p.a1.under.test.com:10001;lr>,<sip:s.a1.under.test.com;lr>,
<sip:s.a2.under.test.com;lr>,<sip:p.a2.under.test.com;lr>
Max-Forwards: 65
From: <sip:UEa2_public_1@under.test.com>;tag=10fxced76sl
To: <sip:UEa1_public_1@under.test.com>
Call-ID: 3848276298220188511@under.test.com
CSeq: 1 INVITE
Contact: <sip:UEa2_public_1@nodea2.under.test.com:22222>
Supported:
Allow: INVITE,ACK,CANCEL,OPTIONS,BYE
Allow-Events: reg
Accept: application/sdp,application/3gpp-ims+xml
P-Called-Party-ID: <sip:UEa1_public_1@under.test.com>
Content-Type: application/sdp
Content-Length: 154

v=0
o=UEa2 2890844526 2890844526 IN IP6 nodea2.under.test.com
s=-
c=IN IP6 nodea2.under.test.com
t=0 0
m=audio 49172 RTP/AVP 0
b=AS:75
a=rtpmap:0 PCMU/8000

2. 180 Ringing NUT -> P-CSCF

SIP/2.0 180 Ringing
Via: SIP/2.0/UDP p.a1.under.test.com:10001;branch=z9hG4bK431e418c233;
received=3ffe:501:ffff:100::10,SIP/2.0/UDP s.a1.under.test.com;
branch=z9hG4bK431e418c4.2;received=3ffe:501:ffff:100::30,SIP/2.0/UDP i.a1.under.test.com;
branch=z9hG4bKnashds418c5a;received=3ffe:501:ffff:100::20,SIP/2.0/UDP
s.a2.under.test.com;branch=z9hG4bK721e418c657u;received=3ffe:501:ffff:200::30,SIP/2.0/UDP
p.a2.under.test.com;branch=z9hG4bKnaghc45ca8;received=3ffe:501:ffff:200::10,SIP/2.0/UDP
[3ffe:501:ffff:2000::1000]:22222;branch=z9hG4bKnashds45ba91
From: <sip:UEa2_public_1@under.test.com>;tag=10fxced76sl
To: <sip:UEa1_public_1@under.test.com>;tag=414259
Call-ID: 3848276298220188511@under.test.com
CSeq: 1 INVITE
Content-Length: 0

3. 200 OK NUT -> P-CSCF



SIP/2.0 200 OK

Via: SIP/2.0/UDP p.a1.under.test.com:10001;branch=z9hG4bK431e418c233;
received=3ffe:501:ffff:100::10,SIP/2.0/UDP s.a1.under.test.com;
branch=z9hG4bK431e418c4.2;received=3ffe:501:ffff:100::30,SIP/2.0/UDP i.a1.under.test.com;
branch=z9hG4bKnashds418c5a;received=3ffe:501:ffff:100::20,SIP/2.0/UDP
s.a2.under.test.com;branch=z9hG4bK721e418c657u;received=3ffe:501:ffff:200::30,SIP/2.0/UDP
p.a2.under.test.com;branch=z9hG4bKnaghc45ca8;received=3ffe:501:ffff:200::10,SIP/2.0/UDP
[3ffe:501:ffff:2000::1000]:22222;branch=z9hG4bKnashds45ba91
Record-Route: <sip:p.a1.under.test.com:10001;lr>,<sip:s.a1.under.test.com;lr>,
<sip:s.a2.under.test.com;lr>,<sip:p.a2.under.test.com;lr>
From: <sip:UEa2_public_1@under.test.com>;tag=10fxced76sl
To: <sip:UEa1_public_1@under.test.com>;tag=414259
Call-ID: 3848276298220188511@under.test.com
CSeq: 1 INVITE
Contact: <sip:UEa1_public_1@node.under.test.com:1357>
Supported:
Allow: INVITE,ACK,CANCEL,OPTIONS,BYE
Allow-Events: reg
Content-Type: application/sdp
Content-Length: 153

v=0
o=UEa1 2890844527 2890844527 IN IP6 node.under.test.com
s=-
c=IN IP6 node.under.test.com
t=0 0
m=audio 3456 RTP/AVP 0
b=AS:75
a=rtpmap:0 PCMU/8000

4. ACK P-CSCF -> NUT

ACK sip:UEa1_public_1@node.under.test.com:1357 SIP/2.0
Via: SIP/2.0/UDP p.a1.under.test.com:10001;branch=z9hG4bK431e418c234,
SIP/2.0/UDP s.a1.under.test.com;branch=z9hG4bK431e418c4.3;
received=3ffe:501:ffff:100::30,SIP/2.0/UDP s.a2.under.test.com;
branch=z9hG4bK721e418c657v;received=3ffe:501:ffff:200::30,SIP/2.0/UDP
p.a2.under.test.com;branch=z9hG4bKnaghc45ca9;received=3ffe:501:ffff:200::10,
SIP/2.0/UDP [3ffe:501:ffff:2000::1000]:22222;branch=z9hG4bKnashds45ba92
Max-Forwards: 66
From: <sip:UEa2_public_1@under.test.com>;tag=10fxced76sl
To: <sip:UEa1_public_1@under.test.com>;tag=414259
Call-ID: 3848276298220188511@under.test.com



CSeq: 1 ACK
Content-Length: 0

5. BYE P-CSCF -> NUT

BYE sip:UEa1_public_1@node.under.test.com:1357 SIP/2.0
Via: SIP/2.0/UDP p.a1.under.test.com:10001;branch=z9hG4bK431e418c235,
SIP/2.0/UDP s.a1.under.test.com;branch=z9hG4bK431e418c4.4;
received=3ffe:501:ffff:100::30,SIP/2.0/UDP s.a2.under.test.com;
branch=z9hG4bK721e418c657x;received=3ffe:501:ffff:200::30,SIP/2.0/UDP
p.a2.under.test.com;branch=z9hG4bKnaghc45ca10;received=3ffe:501:ffff:200::10,
SIP/2.0/UDP [3ffe:501:ffff:2000::1000]:22222;branch=z9hG4bKnashds45ba93
Max-Forwards: 66
From: <sip:UEa2_public_1@under.test.com>;tag=10fxcde76sl
To: <sip:UEa1_public_1@under.test.com>;tag=414259
Call-ID: 3848276298220188511@under.test.com
CSeq: 2 BYE
Content-Length: 0

6. 200 OK NUT -> P-CSCF

SIP/2.0 200 OK
Via: SIP/2.0/UDP p.a1.under.test.com:10001;branch=z9hG4bK431e418c235;
received=3ffe:501:ffff:100::10,SIP/2.0/UDP s.a1.under.test.com;
branch=z9hG4bK431e418c4.4;received=3ffe:501:ffff:100::30,SIP/2.0/UDP
s.a2.under.test.com;branch=z9hG4bK721e418c657x;received=3ffe:501:ffff:200::30,
SIP/2.0/UDP p.a2.under.test.com;branch=z9hG4bKnaghc45ca10;received=3ffe:501:ffff:200::10,
SIP/2.0/UDP [3ffe:501:ffff:2000::1000]:22222;branch=z9hG4bKnashds45ba93
From: <sip:UEa2_public_1@under.test.com>;tag=10fxcde76sl
To: <sip:UEa1_public_1@under.test.com>;tag=414259
Call-ID: 3848276298220188511@under.test.com
CSeq: 2 BYE
Content-Length: 0

[OBSERVABLE RESULTS]

*1: 2 180 response from NUT.

See generic_180-INVITE

*2: 3 200 response from NUT.



See generic_200-INVITE

*3: 6 200 response from NUT.

See generic_200-BYE

4.2.4 UE-SE-B-4-AKA - Session initiation and termination (Receives INVITE and sends BYE)

[NAME]

UE-SE-B-4-AKA - Session initiation and termination (Receives INVITE and sends BYE)

[TARGET]

IMS User Equipment (NUT)

[PURPOSE]

- (1) To verify that the UEa1 properly receives INVITE request and creates the responses relating INVITE request.
- (2) To verify that the UEa1 properly creates BYE request and receives the responses to BYE request.

[REFERENCE]

TS24.229 5.1.2A.1
TS24.229 5.1.2A.2
TS24.229 5.1.4.1

[REQUIREMENT]

NONE

[PARAMETER(NUT)]

public-user-id	:	sip:UEa1_public_1@under.test.com
private-user-id	:	UEa1_private@under.test.com
contact_URI	:	sip:UEa1_public_1@node.under.test.com
HOMENETWORK Domain	:	sip:under.test.com



[PARAMETER(TESTER)]

public-user-id(UEa2) : sip:UEa2_public_1@under.test.com
P-CSCFa1 : sip:p.a1.under.test.com

[ADDRESS]

UEa1(NUT) : 3ffe:501:ffff:1000::1000
Router(R1) : 3ffe:501:ffff:1000::1
P-CSCFa1 : 3ffe:501:ffff:100::10
I-CSCFa1 : 3ffe:501:ffff:100::20
S-CSCFa1 : 3ffe:501:ffff:100::30
DNS : 3ffe:501:ffff:100::40
DHCP : 3ffe:501:ffff:100::50

UEa2 : 3ffe:501:ffff:2000::1000
P-CSCFa2 : 3ffe:501:ffff:200::10
I-CSCFa2 : 3ffe:501:ffff:200::20
S-CSCFa2 : 3ffe:501:ffff:200::30

[TOPOLOGY]

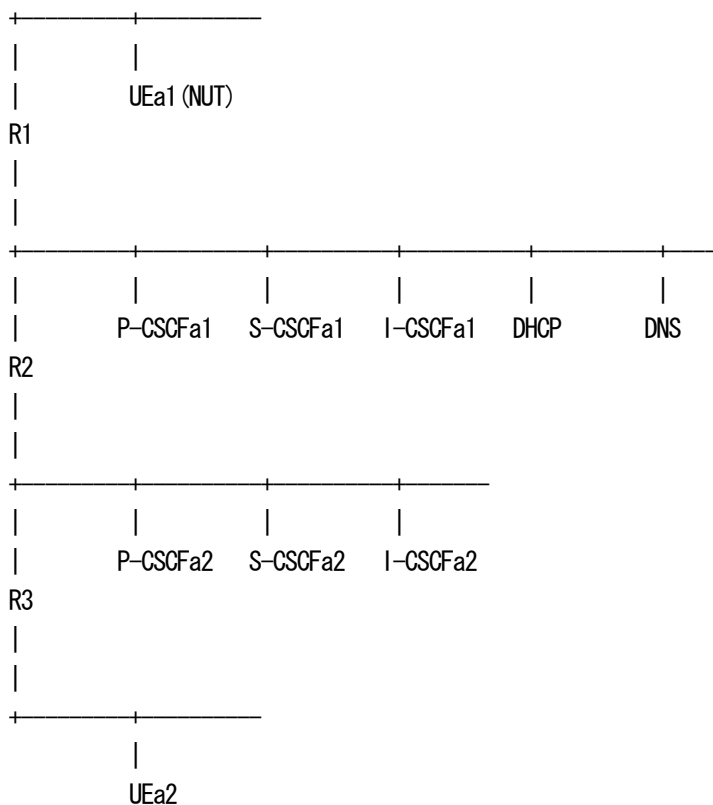



[INITIALIZATION]

UEa1(NUT) must be registered with the tester by executing the scenario "UE-INI-B-1-AKA".

For details of "UE-INI-B-1-AKA", refer to the profile "UE-RG-B-1-AKA".

[PROCEDURE]

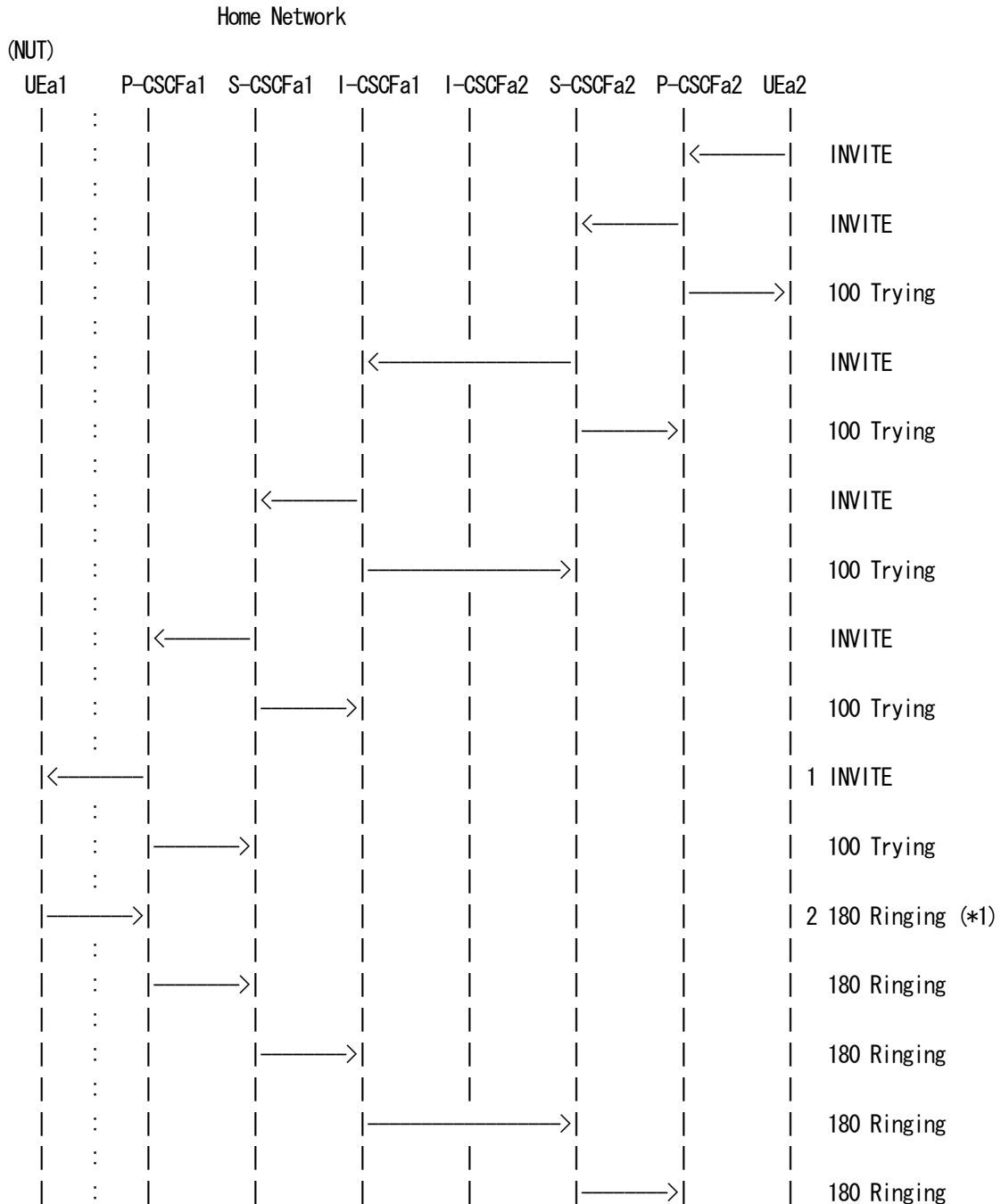

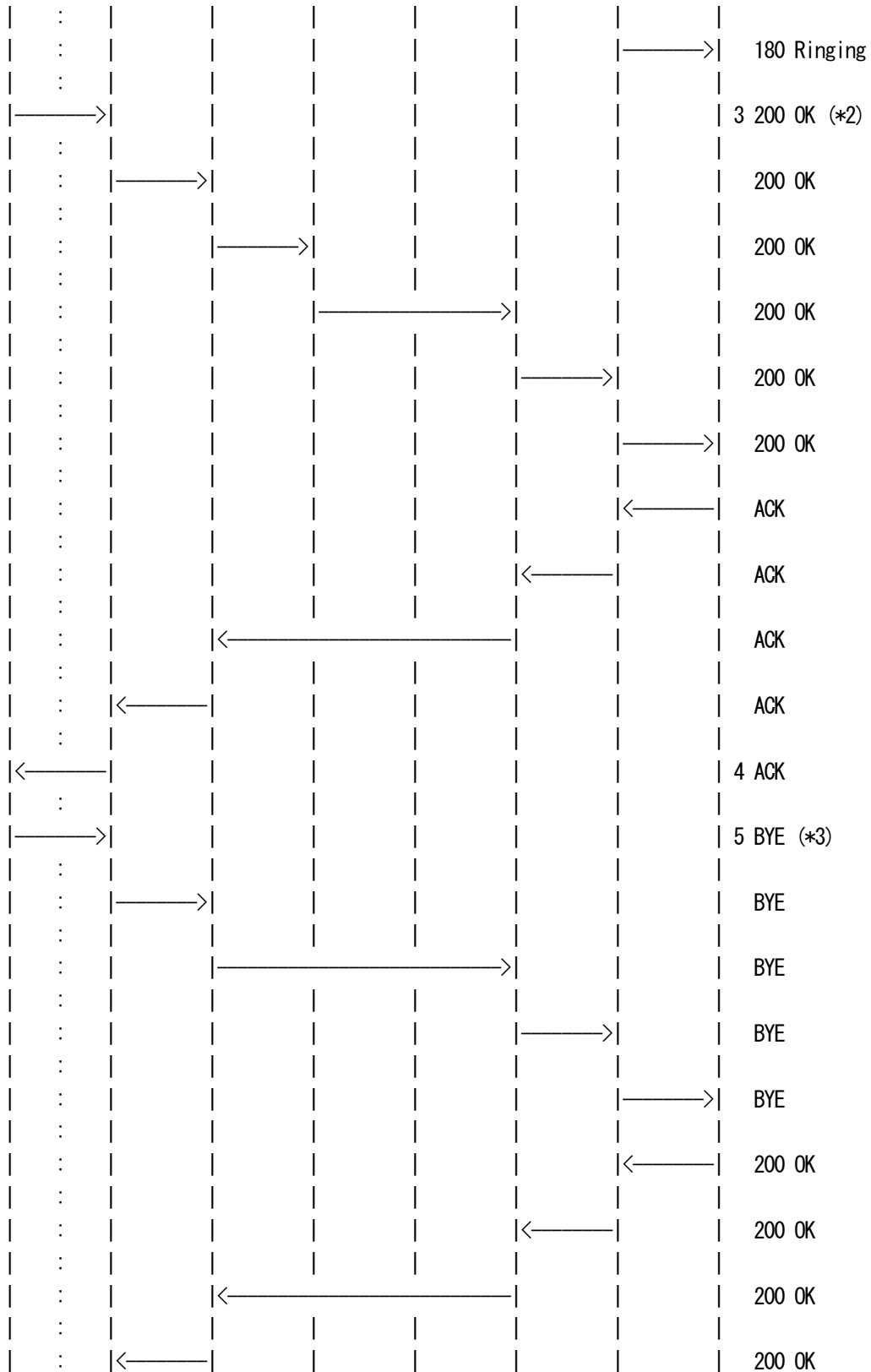

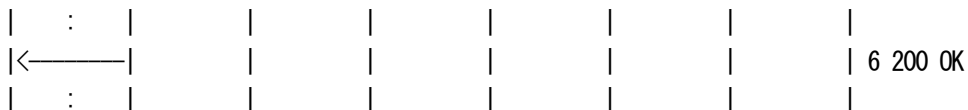

- 1 NUT receives INVITE
- 2 NUT sends 180 Ringing
- 3 NUT sends 200 OK
- 4 NUT receives ACK
- 5 NUT sends BYE
- 6 NUT receives 200 OK

=== Message example ===

1. INVITE P-CSCF -> NUT

```
INVITE sip:UEa1_public_1@node.under.test.com:1357 SIP/2.0
Via: SIP/2.0/UDP p.a1.under.test.com:10001;branch=z9hG4bK431e418c233,
SIP/2.0/UDP s.a1.under.test.com;branch=z9hG4bK431e418c4.2;received=3ffe:501:ffff:100::30,
SIP/2.0/UDP i.a1.under.test.com;branch=z9hG4bKnashds418c5a;received=3ffe:501:ffff:100::20,
SIP/2.0/UDP s.a2.under.test.com;branch=z9hG4bK721e418c657u;received=3ffe:501:ffff:200::30,
SIP/2.0/UDP p.a2.under.test.com;branch=z9hG4bKnaghc45ca8;received=3ffe:501:ffff:200::10,
SIP/2.0/UDP [3ffe:501:ffff:2000::1000];22222;branch=z9hG4bKnashds45ba91
Record-Route: <sip:p.a1.under.test.com:10001;lr>,<sip:s.a1.under.test.com;lr>,
<sip:s.a2.under.test.com;lr>,<sip:p.a2.under.test.com;lr>
Max-Forwards: 65
From: <sip:UEa2_public_1@under.test.com>;tag=10fxced76sl
To: <sip:UEa1_public_1@under.test.com>
Call-ID: 3848276298220188511@under.test.com
CSeq: 1 INVITE
Contact: <sip:UEa2_public_1@nodea2.under.test.com:22222>
Supported:
Allow: INVITE,ACK,CANCEL,OPTIONS,BYE
Allow-Events: reg
Accept: application/sdp,application/3gpp-ims+xml
P-Called-Party-ID: <sip:UEa1_public_1@under.test.com>
Content-Type: application/sdp
Content-Length: 154
```

```
v=0
o=UEa2 2890844526 2890844526 IN IP6 nodea2.under.test.com
s=-
c=IN IP6 nodea2.under.test.com
t=0 0
m=audio 49172 RTP/AVP 0
```



b=AS:75
a=rtpmap:0 PCMU/8000

2. 180 Ringing NUT -> P-CSCF

SIP/2.0 180 Ringing

Via: SIP/2.0/UDP p.a1.under.test.com:10001;branch=z9hG4bK431e418c233;
received=3ffe:501:ffff:100::10,SIP/2.0/UDP s.a1.under.test.com;branch=z9hG4bK431e418c4.2;
received=3ffe:501:ffff:100::30,SIP/2.0/UDP i.a1.under.test.com;branch=z9hG4bKnashds418c5a;
received=3ffe:501:ffff:100::20,SIP/2.0/UDP s.a2.under.test.com;branch=z9hG4bK721e418c657u;
received=3ffe:501:ffff:200::30,SIP/2.0/UDP p.a2.under.test.com;branch=z9hG4bKnaghc45ca8;
received=3ffe:501:ffff:200::10,SIP/2.0/UDP [3ffe:501:ffff:2000::1000]:22222;branch=z9hG4bKnashds45ba91
From: <sip:UEa2_public_1@under.test.com>;tag=10fxcde76sl
To: <sip:UEa1_public_1@under.test.com>;tag=414259
Call-ID: 3848276298220188511@under.test.com
CSeq: 1 INVITE
Content-Length: 0

3. 200 OK NUT -> P-CSCF

SIP/2.0 200 OK

Via: SIP/2.0/UDP p.a1.under.test.com:10001;branch=z9hG4bK431e418c233;
received=3ffe:501:ffff:100::10,SIP/2.0/UDP s.a1.under.test.com;branch=z9hG4bK431e418c4.2;
received=3ffe:501:ffff:100::30,SIP/2.0/UDP i.a1.under.test.com;branch=z9hG4bKnashds418c5a;
received=3ffe:501:ffff:100::20,SIP/2.0/UDP s.a2.under.test.com;branch=z9hG4bK721e418c657u;
received=3ffe:501:ffff:200::30,SIP/2.0/UDP p.a2.under.test.com;branch=z9hG4bKnaghc45ca8;
received=3ffe:501:ffff:200::10,SIP/2.0/UDP [3ffe:501:ffff:2000::1000]:22222;branch=z9hG4bKnashds45ba91
Record-Route: <sip:p.a1.under.test.com:10001;lr>;<sip:s.a1.under.test.com;lr>;
<sip:s.a2.under.test.com;lr>;<sip:p.a2.under.test.com;lr>
From: <sip:UEa2_public_1@under.test.com>;tag=10fxcde76sl
To: <sip:UEa1_public_1@under.test.com>;tag=414259
Call-ID: 3848276298220188511@under.test.com
CSeq: 1 INVITE
Contact: <sip:UEa1_public_1@node.under.test.com:1357>
Supported:
Allow: INVITE,ACK,CANCEL,OPTIONS,BYE
Allow-Events: reg
Content-Type: application/sdp
Content-Length: 153

v=0
o=UEa1 2890844527 2890844527 IN IP6 node.under.test.com
s=-



c=IN IP6 node.under.test.com
t=0 0
m=audio 3456 RTP/AVP 0
b=AS:75
a=rtpmap:0 PCMU/8000

4. ACK P-CSCF -> NUT

ACK sip:UEa1_public_1@node.under.test.com:1357 SIP/2.0
Via: SIP/2.0/UDP p.a1.under.test.com:10001;branch=z9hG4bK431e418c234,
SIP/2.0/UDP s.a1.under.test.com;branch=z9hG4bK431e418c4.3;received=3ffe:501:ffff:100::30,
SIP/2.0/UDP s.a2.under.test.com;branch=z9hG4bK721e418c657v;received=3ffe:501:ffff:200::30,
SIP/2.0/UDP p.a2.under.test.com;branch=z9hG4bKnaghc45ca9;received=3ffe:501:ffff:200::10,
SIP/2.0/UDP [3ffe:501:ffff:2000::1000]:22222;branch=z9hG4bKnashds45ba92
Max-Forwards: 66
From: <sip:UEa2_public_1@under.test.com>;tag=10fxced76sl
To: <sip:UEa1_public_1@under.test.com>;tag=414259
Call-ID: 3848276298220188511@under.test.com
CSeq: 1 ACK
Content-Length: 0

5. BYE NUT -> P-CSCF

BYE sip:UEa2_public_1@nodea2.under.test.com:22222 SIP/2.0
Via: SIP/2.0/UDP [3ffe:501:ffff:1000::1000]:1357;branch=z9hG4bK75ck20
Route: <sip:p.a1.under.test.com:10001;lr>,<sip:s.a1.under.test.com;lr>,
<sip:s.a2.under.test.com;lr>,<sip:p.a2.under.test.com;lr>
Max-Forwards: 70
From: <sip:UEa1_public_1@under.test.com>;tag=414259
To: <sip:UEa2_public_1@under.test.com>;tag=10fxced76sl
Call-ID: 3848276298220188511@under.test.com
CSeq: 2 BYE
Content-Length: 0
Security-Verify: ipsec-3gpp; alg=hmac-sha-1-96; spi-c=256; spi-s=257; port-c=10002; port-s=10001
Require: sec-agree
Proxy-Require: sec-agree

6. 200 OK P-CSCF -> NUT

SIP/2.0 200 OK
Via: SIP/2.0/UDP [3ffe:501:ffff:1000::1000]:1357;branch=z9hG4bK75ck20
From: <sip:UEa1_public_1@under.test.com>;tag=414259
To: <sip:UEa2_public_1@under.test.com>;tag=10fxced76sl



Call-ID: 3848276298220188511 @under.test.com

CSeq: 2 BYE

Content-Length: 0

[OBSERVABLE RESULTS]

*1: 2 180 response from NUT.

See generic_180-INVITE

*2: 3 200 response from NUT.

See generic_200-INVITE

*3: 5 BYE request from NUT to P-CSCF.

See generic_BYE

4.2.5 UE-SE-B-5-AKA - Call cancellation (Sends INVITE and sends CANCEL)

[NAME]

UE-SE-B-5-AKA - Call Cancellation (Sends INVITE and sends CANCEL)

[TARGET]

IMS User Equipment (NUT)

[PURPOSE]

(1) To verify that the UEa1 properly creates a CANCEL request.

(2) To verify that the UEa1 properly process a 487 (Request Terminated) response and creates an ACK request.

[REFERENCE]

TS24.229 A.2.1.3

RFC3261 9

[REQUIREMENT]



NONE

[PARAMETER(NUT)]

public-user-id : sip:UEa1_public_1@under.test.com
private-user-id : UEa1_private@under.test.com
contact_URI : sip:UEa1_public_1@node.under.test.com
HOMENETWORK Domain : sip:under.test.com

[PARAMETER(TESTER)]

public-user-id(UEa2) : sip:UEa2_public_1@under.test.com
P-CSCFa1 : sip:p.a1.under.test.com

[ADDRESS]

UEa1(NUT) : 3ffe:501:fff:1000::1000
Router(R1) : 3ffe:501:fff:1000::1
P-CSCFa1 : 3ffe:501:fff:100::10
I-CSCFa1 : 3ffe:501:fff:100::20
S-CSCFa1 : 3ffe:501:fff:100::30
DNS : 3ffe:501:fff:100::40
DHCP : 3ffe:501:fff:100::50

UEa2 : 3ffe:501:fff:2000::1000
P-CSCFa2 : 3ffe:501:fff:200::10
I-CSCFa2 : 3ffe:501:fff:200::20
S-CSCFa2 : 3ffe:501:fff:200::30

[TOPOLOGY]

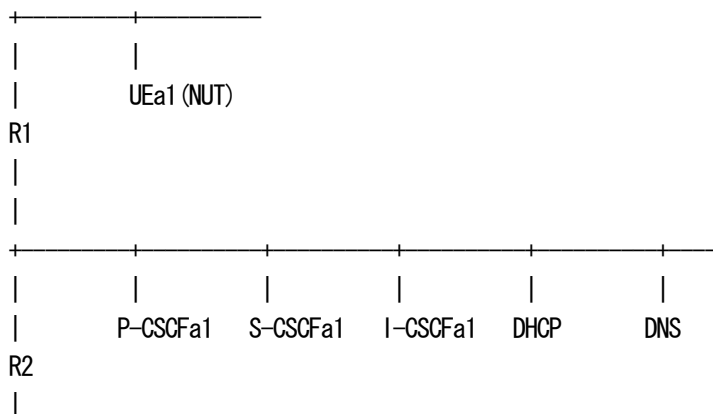

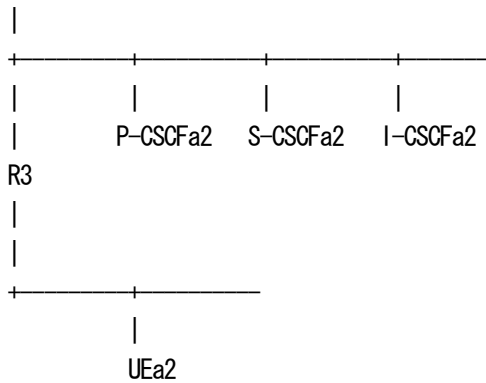

[INITIALIZATION]

UEa1(NUT) must be registered with the tester by executing the scenario "UE-INI-B-1-AKA".
 For details of "UE-INI-B-1-AKA", refer to the profile "UE-RG-B-1-AKA".

[PROCEDURE]

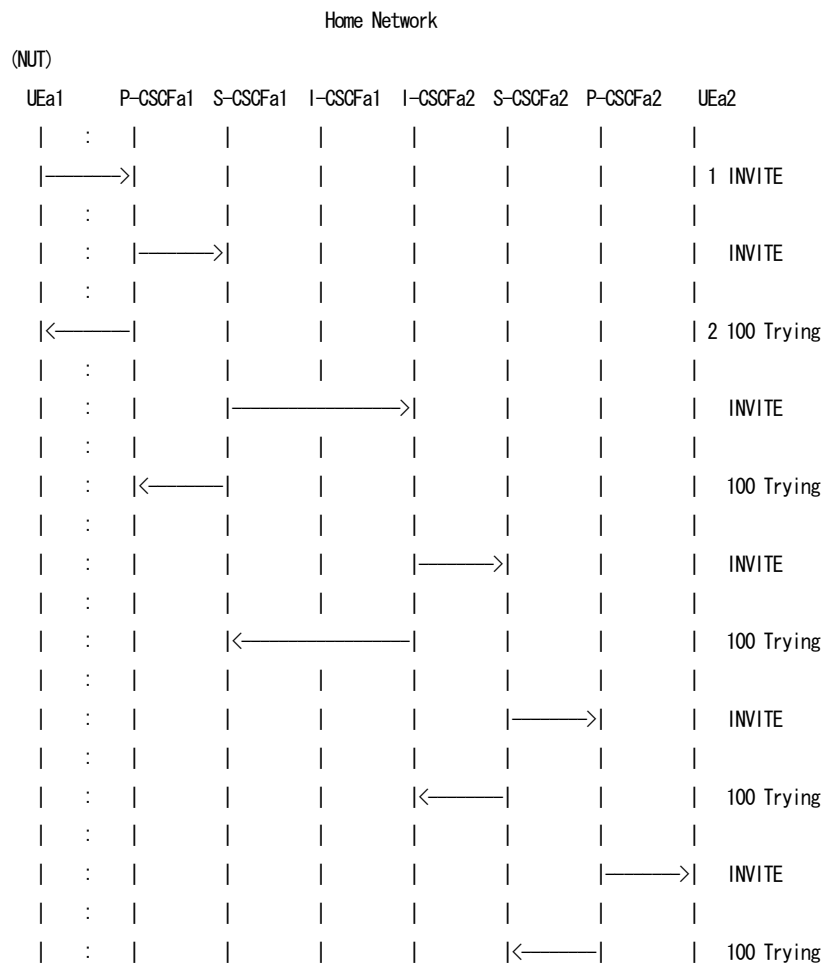

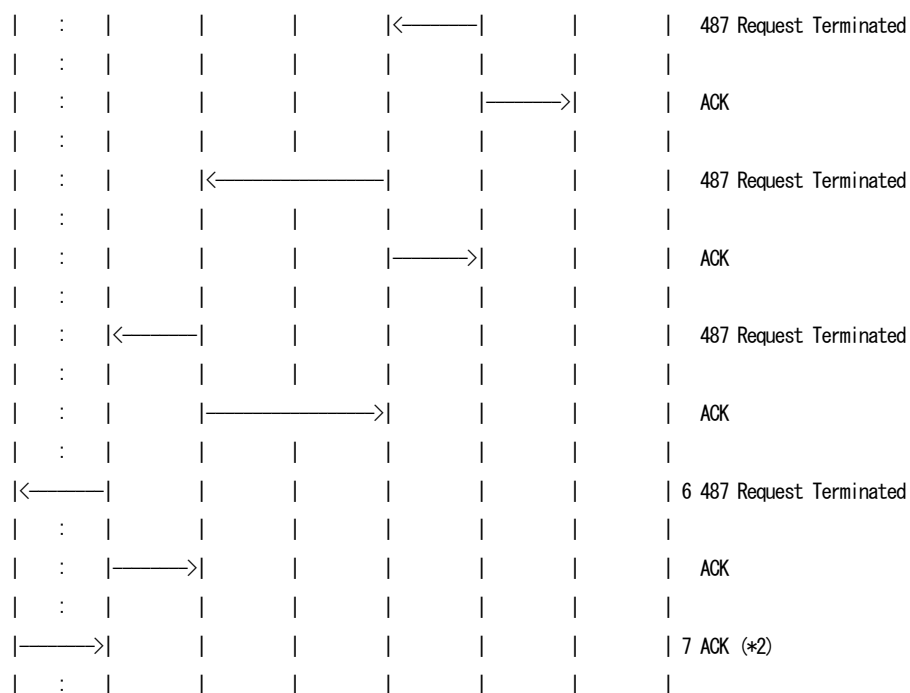

- 1 NUT sends INVITE
- 2 NUT receives 100 Trying
- 3 NUT receives 180 Ringing
- 4 NUT sends CANCEL
- 5 NUT receives 200 OK
- 6 NUT receives 487 Request Terminated
- 7 NUT sends ACK

=== Message example ===

As regards the message 1, please refer to the message 1 in UE-SE-B-1-AKA.

2. 100 Trying P-CSCF -> NUT

SIP/2.0 100 Trying

Via: SIP/2.0/UDP [3ffe:501:ffff:1000::1000]:1357;branch=z9hG4bK74bf9

From: < sip:UEa1_public_1@under.test.com>;tag=9fxced76sl

To: < sip:UEa2_public_1@under.test.com>

Call-ID: 3848276298220188511@under.test.com

CSeq: 1 INVITE

Content-Length: 0

3. 180 Ringing P-CSCF -> NUT



SIP/2.0 180 Ringing
Via: SIP/2.0/UDP [3ffe:501:ffff:1000::1000]:1357;branch=z9hG4bK74bf9
From: <sip:UEa1_public_1@under.test.com>;tag=9fxced76sl
To: <sip:UEa2_public_1@under.test.com>;tag=314259
Call-ID: 3848276298220188511@under.test.com
CSeq: 1 INVITE
Content-Length: 0

4. CANCEL NUT -> P-CSCF

CANCEL sip:UEa2_public_1@under.test.com SIP/2.0
Via: SIP/2.0/UDP [3ffe:501:ffff:1000::1000]:1357;branch=z9hG4bK74bf9
Route: <sip:p.a1.under.test.com:10001;lr>,<sip:orig@s.a1.under.test.com;lr>
Max-Forwards: 70
From: <sip:UEa1_public_1@under.test.com>;tag=9fxced76sl
To: <sip:UEa2_public_1@under.test.com>
Call-ID: 3848276298220188511@under.test.com
CSeq: 1 CANCEL
Content-Length: 0

5. 200 OK P-CSCF -> NUT

SIP/2.0 200 OK
Via: SIP/2.0/UDP [3ffe:501:ffff:1000::1000]:1357;branch=z9hG4bK74bf9
From: <sip:UEa1_public_1@under.test.com>;tag=9fxced76sl
To: <sip:UEa2_public_1@under.test.com>;tag=314160
Call-ID: 3848276298220188511@under.test.com
CSeq: 1 CANCEL
Content-Length: 0

6. 487 Request Terminated P-CSCF -> NUT

SIP/2.0 487 Request Terminated
Via: SIP/2.0/UDP [3ffe:501:ffff:1000::1000]:1357;branch=z9hG4bK74bf9
From: <sip:UEa1_public_1@under.test.com>;tag=9fxced76sl
To: <sip:UEa2_public_1@under.test.com>;tag=314259
Call-ID: 3848276298220188511@under.test.com
CSeq: 1 INVITE
Content-Length: 0

7. ACK NUT -> P-CSCF

ACK sip:UEa2_public_1@under.test.com SIP/2.0



Via: SIP/2.0/UDP [3ffe:501:ffff:1000::1000]:1357;branch=z9hG4bK74bf9
Route: <sip:p.a1.under.test.com:10001;lr>,<sip:orig@s.a1.under.test.com;lr>
Max-Forwards: 70
From: <sip:UEa1_public_1@under.test.com>;tag=9fxced76sl
To: <sip:UEa2_public_1@under.test.com>;tag=314259
Call-ID: 3848276298220188511@under.test.com
CSeq: 1 ACK
Content-Length: 0

[OBSERVABLE RESULTS]

*1: 4 CANCEL from NUT to P-CSCF.

See generic_CANCEL

*2: 7 ACK from NUT to P-CSCF.

See generic_ACK-non2XX

4.2.6 UE-SE-B-6-AKA - Call cancellation (Receives INVITE and receives CANCEL)

[NAME]

UE-SE-B-6-AKA - Call Cancellation (Receives INVITE and receives CANCEL)

[TARGET]

IMS User Equipment (NUT)

[PURPOSE]

(1) Verify that the UEa1 properly creates a 200 (OK) to CANCEL request.

(2) Verify that the UEa1 properly creates a 487 (Request Terminated) response.

[REFERENCE]

TS24.229 A.2.1.3

RFC3261 9



[REQUIREMENT]

NONE

[PARAMETER(NUT)]

public-user-id : sip:UEa1_public_1@under.test.com
private-user-id : UEa1_private@under.test.com
contact_URI : sip:UEa1_public_1@node.under.test.com
HOMENETWORK Domain : sip:under.test.com

[PARAMETER(TESTER)]

public-user-id(UEa2) : sip:UEa2_public_1@under.test.com
P-CSCFa1 : sip:p.a1.under.test.com

[ADDRESS]

UEa1(NUT) : 3ffe:501:fff:1000::1000
Router(R1) : 3ffe:501:fff:1000::1
P-CSCFa1 : 3ffe:501:fff:100::10
I-CSCFa1 : 3ffe:501:fff:100::20
S-CSCFa1 : 3ffe:501:fff:100::30
DNS : 3ffe:501:fff:100::40
DHCP : 3ffe:501:fff:100::50

UEa2 : 3ffe:501:fff:2000::1000
P-CSCFa2 : 3ffe:501:fff:200::10
I-CSCFa2 : 3ffe:501:fff:200::20
S-CSCFa2 : 3ffe:501:fff:200::30

[TOPOLOGY]

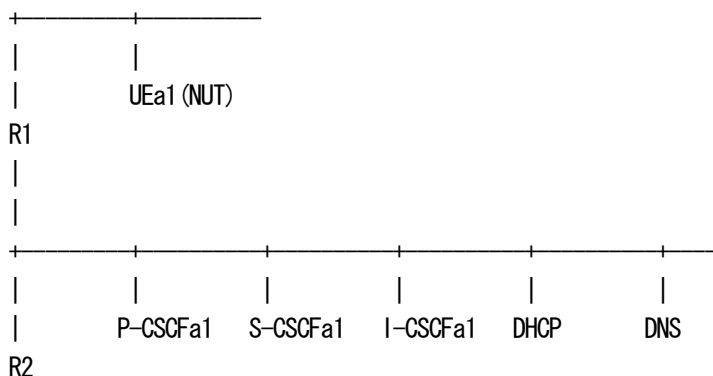

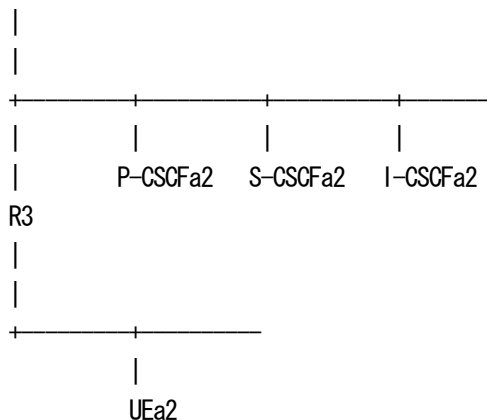

[INITIALIZATION]

UEa1(NUT) must be registered with the tester by executing the scenario "UE-INI-B-1-AKA".
For details of "UE-INI-B-1-AKA", refer to the profile "UE-RG-B-1-AKA".

[PROCEDURE]

Home Network

(NUT)

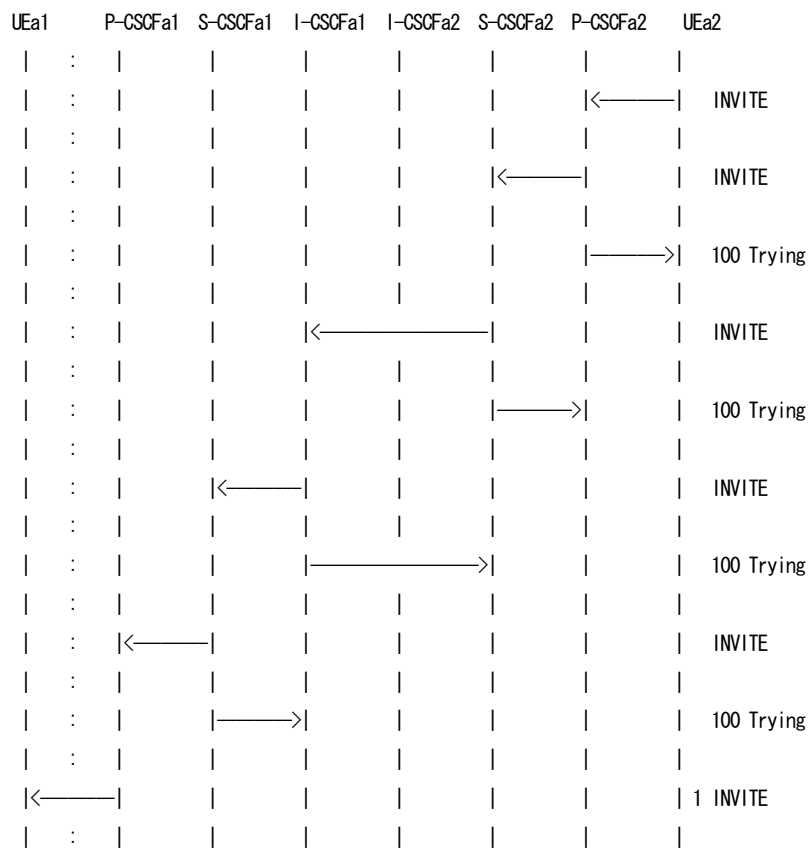

	:		→							100 Trying
	:									
	→									2 180 Ringing
	:									
	:		→							180 Ringing
	:									
	:			→						180 Ringing
	:				→					
	:					→				180 Ringing
	:									
	:								→	180 Ringing
	:									
	:								←	CANCEL
	:									
	:								←	CANCEL
	:									
	:								→	200 OK
	:									
	:								←	CANCEL
	:									
	:								→	200 OK
	:									
	:								←	CANCEL
	:									
	:								→	200 OK
	:									
	:								←	CANCEL
	:									
	:								→	200 OK
	:									
	:								←	3 CANCEL
	:									
	:								→	200 OK
	:									
									→	4 200 OK (*1)
	:									
									→	5 487 Request Terminated (*2)
	:									
	:								→	487 Request Terminated
	:									
									←	6 ACK

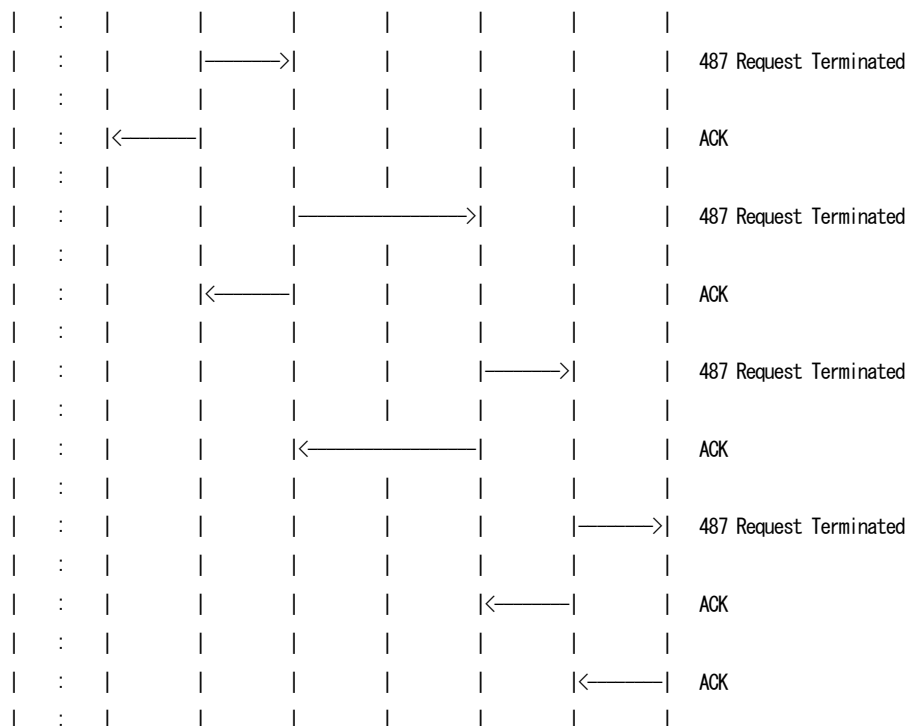

- 1 NUT receives INVITE
- 2 NUT sends 180 Ringing
- 3 NUT receives CANCEL
- 4 NUT sends 200 OK
- 5 NUT sends 487 Request Terminated
- 6 NUT receives ACK

=== Message example ===

1. INVITE P-CSCF -> NUT

INVITE sip:UEa1_public_1@node.under.test.com:1357 SIP/2.0

Via: SIP/2.0/UDP p.a1.under.test.com:10001;branch=z9hG4bK431e418c233,

SIP/2.0/UDP s.a1.under.test.com;branch=z9hG4bK431e418c4.2;received=3ffe:501:ffff:100::30,

SIP/2.0/UDP i.a1.under.test.com;branch=z9hG4bKnashds418c5a;received=3ffe:501:ffff:100::20,

SIP/2.0/UDP s.a2.under.test.com;branch=z9hG4bK721e418c657u;received=3ffe:501:ffff:200::30,

SIP/2.0/UDP p.a2.under.test.com;branch=z9hG4bKnaghc45ca8;received=3ffe:501:ffff:200::10,

SIP/2.0/UDP [3ffe:501:ffff:2000::1000]:22222;branch=z9hG4bKnashds45ba91

Record-Route: <sip:p.a1.under.test.com:10001;lr>,<sip:s.a1.under.test.com;lr>,<sip:s.a2.under.test.com;lr>,<sip:p.a2.under.test.com;lr>

Max-Forwards: 65

From: <sip:UEa2_public_1@under.test.com>;tag=10fxced76sl

To: <sip:UEa1_public_1@under.test.com>



Call-ID: 3848276298220188511@under.test.com
CSeq: 1 INVITE
Contact: <sip:UEa2_public_1@nodea2.under.test.com:22222>
Supported:
Allow: INVITE,ACK,CANCEL,OPTIONS,BYE
Allow-Events: reg
Accept: application/sdp,application/3gpp-ims+xml
P-Called-Party-ID: <sip:UEa1_public_1@under.test.com>
Content-Type: application/sdp
Content-Length: 154

v=0
o=UEa2 2890844526 2890844526 IN IP6 nodea2.under.test.com
s=-
c=IN IP6 nodea2.under.test.com
t=0 0
m=audio 49172 RTP/AVP 0
b=AS:75
a=rtpmap:0 PCMU/8000

2. 180 Ringing NUT -> P-CSCF

SIP/2.0 180 Ringing
Via: SIP/2.0/UDP p.a1.under.test.com:10001;branch=z9hG4bK431e418c233;
received=3ffe:501:ffff:100::10,SIP/2.0/UDP s.a1.under.test.com;branch=z9hG4bK431e418c4.2;
received=3ffe:501:ffff:100::30,SIP/2.0/UDP i.a1.under.test.com;branch=z9hG4bKnashds418c5a;
received=3ffe:501:ffff:100::20,SIP/2.0/UDP s.a2.under.test.com;branch=z9hG4bK721e418c657u;
received=3ffe:501:ffff:200::30,SIP/2.0/UDP p.a2.under.test.com;branch=z9hG4bKnaghc45ca8;
received=3ffe:501:ffff:200::10,SIP/2.0/UDP [3ffe:501:ffff:2000::1000]:22222;branch=z9hG4bKnashds45ba91
From: <sip:UEa2_public_1@under.test.com>;tag=10fxcde76sl
To: <sip:UEa1_public_1@under.test.com>;tag=414259
Call-ID: 3848276298220188511@under.test.com
CSeq: 1 INVITE
Content-Length: 0

3. CANCEL P-CSCF -> NUT

CANCEL sip:UEa1_public_1@node.under.test.com:1357 SIP/2.0
Via: SIP/2.0/UDP p.a1.under.test.com:10001;branch=z9hG4bK431e418c233
Max-Forwards: 70
From: <sip:UEa2_public_1@under.test.com>;tag=10fxcde76sl
To: <sip:UEa1_public_1@under.test.com>
Call-ID: 3848276298220188511@under.test.com



CSeq: 1 CANCEL
Content-Length: 0

4. 200 OK NUT -> P-CSCF

SIP/2.0 200 OK

Via: SIP/2.0/UDP p.a1.under.test.com:10001;branch=z9hG4bK431e418c233;received=3ffe:501:ffff:100::10

From: <sip:UEa2_public_1@under.test.com>;tag=10fxced76sl

To: <sip:UEa1_public_1@under.test.com>;tag=314160

Call-ID: 3848276298220188511@under.test.com

CSeq: 1 CANCEL

Content-Length: 0

5. 487 Request Terminated NUT -> P-CSCF

SIP/2.0 487 Request Terminated

Via: SIP/2.0/UDP p.a1.under.test.com:10001;branch=z9hG4bK431e418c233;received=3ffe:501:ffff:100::10,

SIP/2.0/UDP s.a1.under.test.com;branch=z9hG4bK431e418c4.2;received=3ffe:501:ffff:100::30,

SIP/2.0/UDP i.a1.under.test.com;branch=z9hG4bKnashds418c5a;received=3ffe:501:ffff:100::20,

SIP/2.0/UDP s.a2.under.test.com;branch=z9hG4bK721e418c657u;received=3ffe:501:ffff:200::30,

SIP/2.0/UDP p.a2.under.test.com;branch=z9hG4bKnaghc45ca8;received=3ffe:501:ffff:200::10,

SIP/2.0/UDP [3ffe:501:ffff:2000::1000]:22222;branch=z9hG4bKnashds45ba91

From: <sip:UEa2_public_1@under.test.com>;tag=10fxced76sl

To: <sip:UEa1_public_1@under.test.com>;tag=414259

Call-ID: 3848276298220188511@under.test.com

CSeq: 1 INVITE

Content-Length: 0

6. ACK P-CSCF -> NUT

ACK sip:UEa1_public_1@node.under.test.com:1357 SIP/2.0

Via: SIP/2.0/UDP p.a1.under.test.com:10001;branch=z9hG4bK431e418c233

Max-Forwards: 70

From: <sip:UEa2_public_1@under.test.com>;tag=10fxced76sl

To: <sip:UEa1_public_1@under.test.com>;tag=414259

Call-ID: 3848276298220188511@under.test.com

CSeq: 1 ACK

Content-Length: 0

[OBSERVABLE RESULTS]

*1: 4 CANCEL 200 OK from NUT to P-CSCF.



See generic_200-CANCEL

*2: 5 487 Request Terminated from NUT to P-CSCF.

See generic_3XX-6XX

- Exception{

* To

If a request contained a To tag in the request, the To header field in the response MUST equal that of the request.[RFC3261-8.2-41]

If the To header field in the request did not contain a tag, the UAS MUST add a tag to the To header field in the response. [RFC3261-8.2-43]

}

- Status-Line:

The Status-Code in the Status-Line SHOULD be a 487 (Request Terminated).
[RFC3261-9.2-2]

4.2.7 UE-SE-B-7-AKA - SIP response received from the P-CSCF outside of the registration

[NAME]

UE-SE-B-7-AKA - SIP response received from the P-CSCF outside of the registration

[TARGET]

IMS User Equipment (NUT)

[PURPOSE]

To verify that the UEa1 properly discards any SIP response that is not protected by the security association and is received from the P-CSCF outside of the registration.

[REFERENCE]

TS24229 5.1.2A.1.1

[REQUIREMENT]

NONE



[PARAMETER(NUT)]

public-user-id : sip:UEa1_public_1@under.test.com
private-user-id : UEa1_private@under.test.com
contact_URI : sip:UEa1_public_1@node.under.test.com
HOMENETWORK Domain : sip:under.test.com

[PARAMETER(TESTER)]

public-user-id(UEa2) : sip:UEa2_public_1@under.test.com
P-CSCFa1 : sip:p.a1.under.test.com
P-CSCFa2 : sip:p.a2.under.test.com

[ADDRESS]

UEa1(NUT) : 3ffe:501:fff:1000::1000
Router(R1) : 3ffe:501:fff:1000::1
P-CSCFa1 : 3ffe:501:fff:100::10
I-CSCFa1 : 3ffe:501:fff:100::20
S-CSCFa1 : 3ffe:501:fff:100::30
DNS : 3ffe:501:fff:100::40
DHCP : 3ffe:501:fff:100::50
UEa2 : 3ffe:501:fff:2000::1000
P-CSCFa2 : 3ffe:501:fff:200::10
I-CSCFa2 : 3ffe:501:fff:200::20
S-CSCFa2 : 3ffe:501:fff:200::30

[TOPOLOGY]

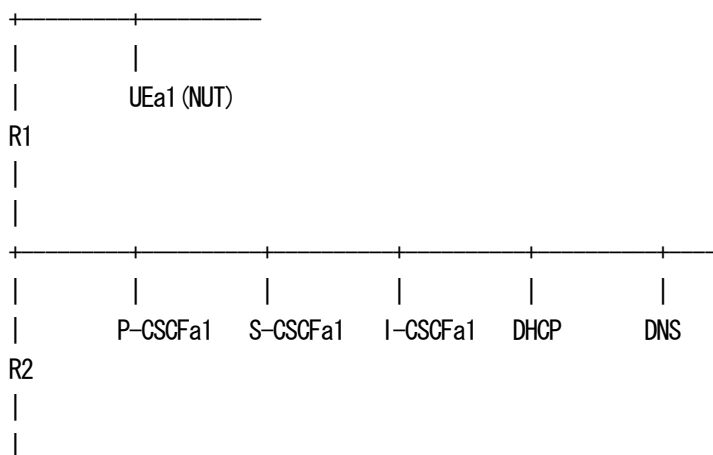

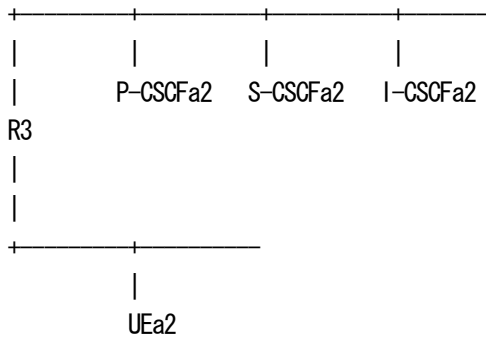

[INITIALIZATION]

UEa1 (NUT) must be registered with the tester by executing the scenario "UE-INI-B-1-AKA".
 For details of "UE-INI-B-1-AKA", refer to the profile "UE-RG-B-1-AKA".

[PROCEDURE]

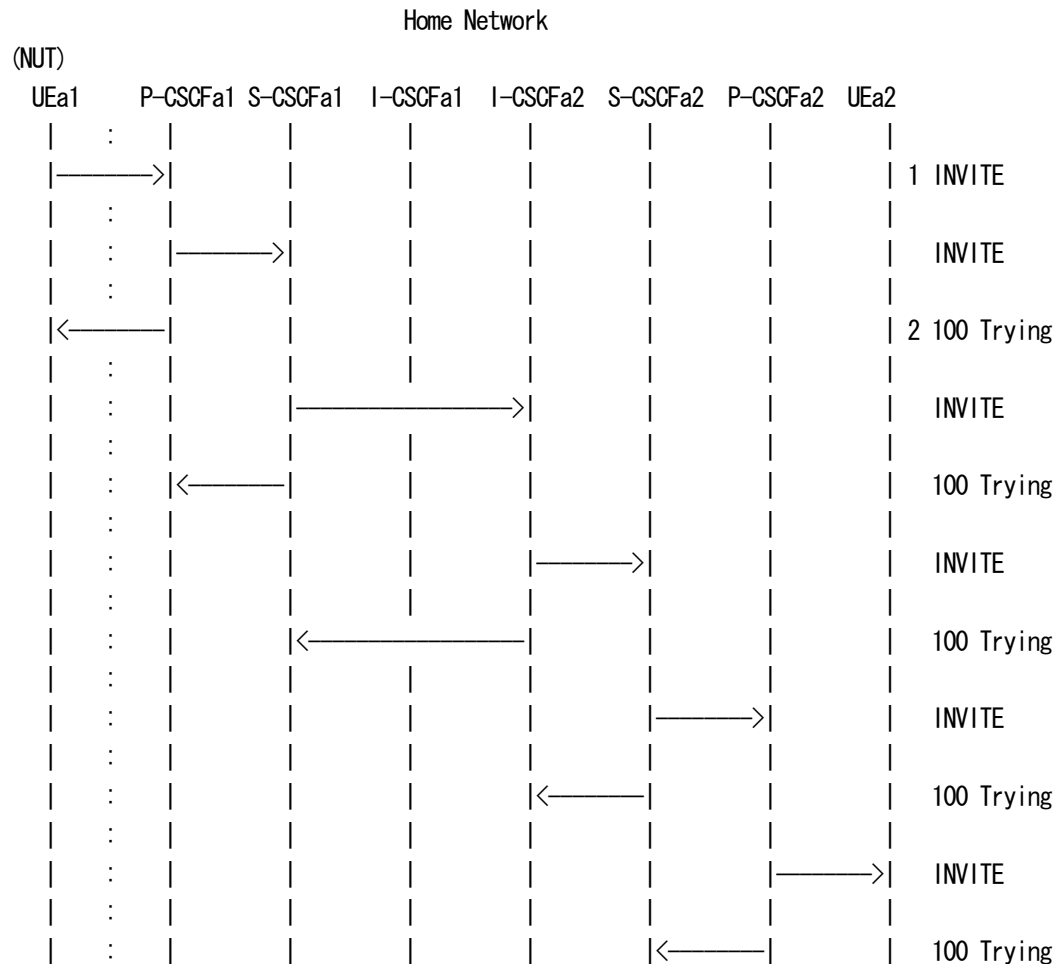

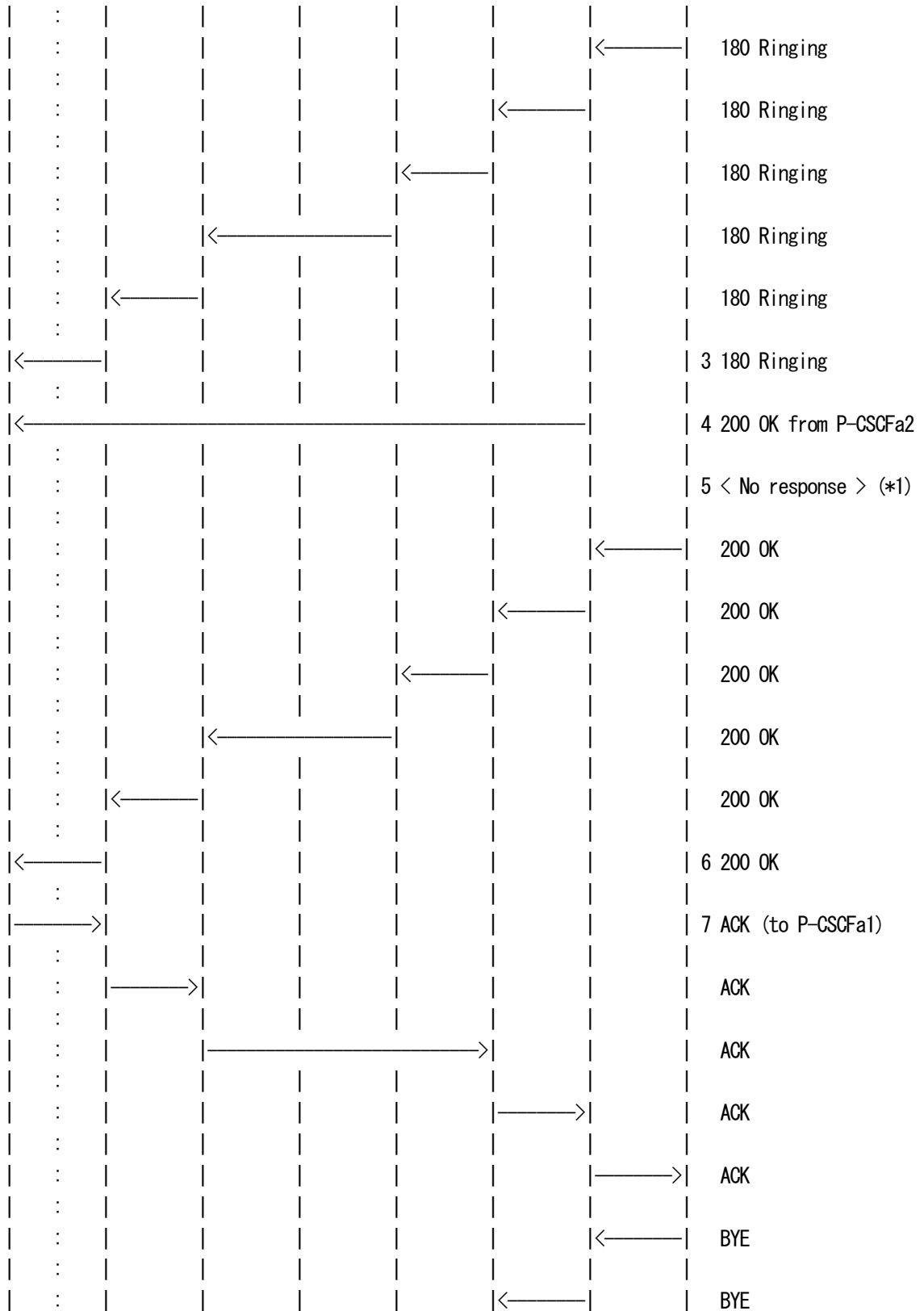

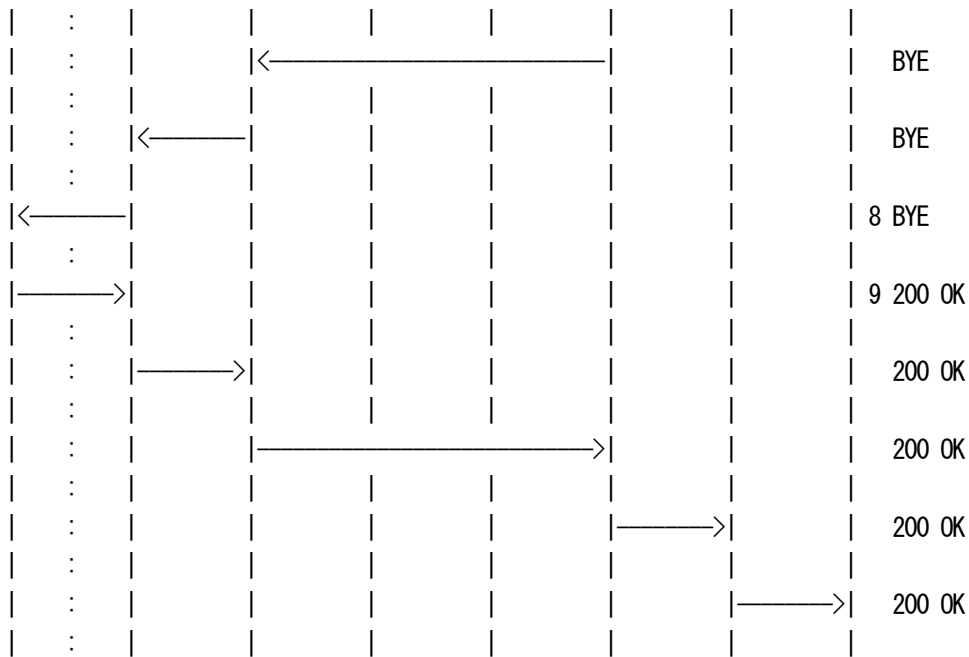

- 1 NUT sends INVITE
- 2 NUT receives 100 Trying
- 3 NUT receives 180 Ringing
- 4 NUT receives 200 OK from P-CSCFa2
- 5 <No response>
- 6 NUT receives 200 OK from P-CSCFa1
- 7 NUT sends ACK
- 8 NUT receives BYE
- 9 NUT sends 200 OK

=== Message example ===

As regards the message 1-3, please refer to the message 1-3 in UE-SE-B-1-AKA.

4. 200 OK P-CSCFa2 -> NUT

SIP/2.0 200 OK

Via: SIP/2.0/UDP [3ffe:501:ffff:1000::1000]:1357;branch=z9hG4bK74bf9

Record-Route: <sip:p.a2.under.test.com:10001;lr>

From: <sip:UEa1_public_1@under.test.com>;tag=9fxced76sl

To: <sip:UEa2_public_1@under.test.com>;tag=314259

Call-ID: 3848276298220188511@under.test.com

CSeq: 1 INVITE

Contact: <sip:UEa2_public_1@nodea2.under.test.com:22222>

Supported:



Allow: INVITE,ACK,CANCEL,OPTIONS,BYE

Allow-Events: reg

Content-Type: application/sdp

Content-Length: 153

v=0

o=UEa2 2890844527 2890844527 IN IP6 nodea2.under.test.com

s=-

c=IN IP6 nodea2.under.test.com

t=0 0

m=audio 3456 RTP/AVP 0

b=AS:75

a=rtpmap:0 PCMU/8000

5. <No response>

6. 200 OK P-CSCF -> NUT

SIP/2.0 200 OK

Via: SIP/2.0/UDP [3ffe:501:ffff:1000::1000]:1357;branch=z9hG4bK74bf9

Record-Route: <sip:p.a2.under.test.com;lr>,<sip:s.a2.under.test.com;lr>,<sip:s.a1.under.test.com;lr>,<sip:p.a1.under.test.com:10001;lr>

From: <sip:UEa1_public_1@under.test.com>;tag=9fxced76sl

To: <sip:UEa2_public_1@under.test.com>;tag=314259

Call-ID: 3848276298220188511@under.test.com

CSeq: 1 INVITE

Contact: <sip:UEa2_public_1@nodea2.under.test.com:22222>

Supported:

Allow: INVITE,ACK,CANCEL,OPTIONS,BYE

Allow-Events: reg

Content-Type: application/sdp

Content-Length: 153

v=0

o=UEa2 2890844527 2890844527 IN IP6 nodea2.under.test.com

s=-

c=IN IP6 nodea2.under.test.com

t=0 0

m=audio 3456 RTP/AVP 0

b=AS:75

a=rtpmap:0 PCMU/8000



7. ACK NUT -> P-CSCF

ACK sip:UEa2_public_1@nodea2.under.test.com:22222 SIP/2.0
Via: SIP/2.0/UDP [3ffe:501:ffff:1000::1000]:1357;branch=z9hG4bK74bf10
Route: <sip:p.a1.under.test.com:10001;lr>,<sip:s.a1.under.test.com;lr>,
<sip:s.a2.under.test.com;lr>,<sip:p.a2.under.test.com;lr>
Max-Forwards: 70
From: <sip:UEa1_public_1@under.test.com>;tag=9fxced76sl
To: <sip:UEa2_public_1@under.test.com>;tag=314259
Call-ID: 3848276298220188511@under.test.com
CSeq: 1 ACK
Content-Length: 0

8. BYE P-CSCF -> NUT

BYE sip:UEa1_public_1@node.under.test.com:1357 SIP/2.0
Via: SIP/2.0/UDP p.a1.under.test.com:10001;branch=z9hG4bK431e418c501,
SIP/2.0/UDP s.a1.under.test.com;branch=z9hG4bKnashdsa2.3;received=3ffe:501:ffff:100::30,
SIP/2.0/UDP s.a2.under.test.com;branch=z9hG4bK721e418c9.1;received=3ffe:501:ffff:200::30,
SIP/2.0/UDP p.a2.under.test.com;branch=z9hG4bKnaghds30;received=3ffe:501:ffff:200::10,
SIP/2.0/UDP [3ffe:501:ffff:2000::1000]:22222;branch=z9hG4bKnashdsb3
Max-Forwards: 66
From: <sip:UEa2_public_1@under.test.com>;tag=314259
To: <sip:UEa1_public_1@under.test.com>;tag=9fxced76sl
Call-ID: 3848276298220188511@under.test.com
CSeq: 2 BYE
Content-Length: 0

9. 200 OK NUT -> P-CSCF

SIP/2.0 200 OK
Via: SIP/2.0/UDP p.a1.under.test.com:10001;branch=z9hG4bK431e418c501;
received=3ffe:501:ffff:100::10,SIP/2.0/UDP s.a1.under.test.com;branch=z9hG4bKnashdsa2.3;
received=3ffe:501:ffff:100::30,SIP/2.0/UDP s.a2.under.test.com;branch=z9hG4bK721e418c9.1;
received=3ffe:501:ffff:200::30,SIP/2.0/UDP p.a2.under.test.com;branch=z9hG4bKnaghds30;
received=3ffe:501:ffff:200::10,SIP/2.0/UDP [3ffe:501:ffff:2000::1000]:22222;branch=z9hG4bKnashdsb3
From: <sip:UEa2_public_1@under.test.com>;tag=314259
To: <sip:UEa1_public_1@under.test.com>;tag=9fxced76sl
Call-ID: 3848276298220188511@under.test.com
CSeq: 2 BYE
Content-Length: 0

[OBSERVABLE RESULTS]



*1: 5 No response

The UE SHALL discard any SIP response that is not protected by the security association and is received from the P-CSCF outside of the registration and authentication procedures.[TS24229-5.1-196]

4.2.8 UE-SE-B-8-AKA - SIP Request received from the P-CSCF outside of the registration

[NAME]

UE-SE-B-8-AKA - SIP Request received from the P-CSCF outside of the registration

[TARGET]

IMS User Equipment (NUT)

[PURPOSE]

To verify that the UEa1 properly discards any SIP request that is not protected by the security association and is received from the P-CSCF outside of the registration.

[REFERENCE]

TS24.229 5.1.2A.2

[REQUIREMENT]

NONE

[PARAMETER(NUT)]

public-user-id : sip:UEa1_public_1@under.test.com
private-user-id : UEa1_private@under.test.com
Contact_URI : sip:UEa1_public_1@node.under.test.com
HOMENETWORK Domain : sip:under.test.com

[PARAMETER(TESTER)]

P-CSCFa1 : sip:p.a1.under.test.com
P-CSCFa2 : sip:p.a2.under.test.com



S-CSCFa1 : sip:s.a1.under.test.com

[ADDRESS]

UEa1(NUT) : 3ffe:501:fff:1000::1000
 Router(R1) : 3ffe:501:fff:1000::1
 P-CSCFa1 : 3ffe:501:fff:100::10
 P-CSCFa2 : 3ffe:501:fff:200::10
 I-CSCFa1 : 3ffe:501:fff:100::20
 S-CSCFa1 : 3ffe:501:fff:100::30
 DNS : 3ffe:501:fff:100::40
 DHCP : 3ffe:501:fff:100::50

[TOPOLOGY]

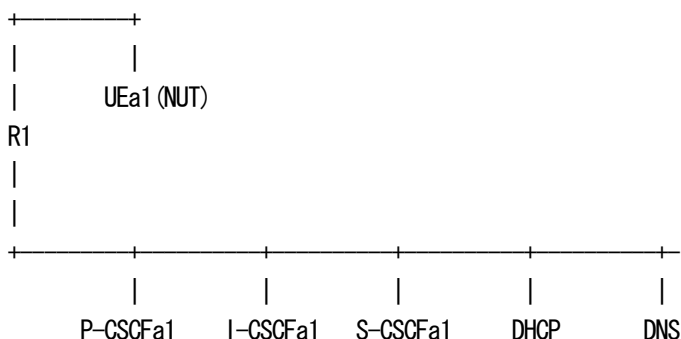

[INITIALIZATION]

UEa1(NUT) must be registered with the tester by executing the scenario "UE-INI-B-1-AKA".
 For details of "UE-INI-B-1-AKA", refer to the profile "UE-RG-B-1-AKA".

[PROCEDURE]

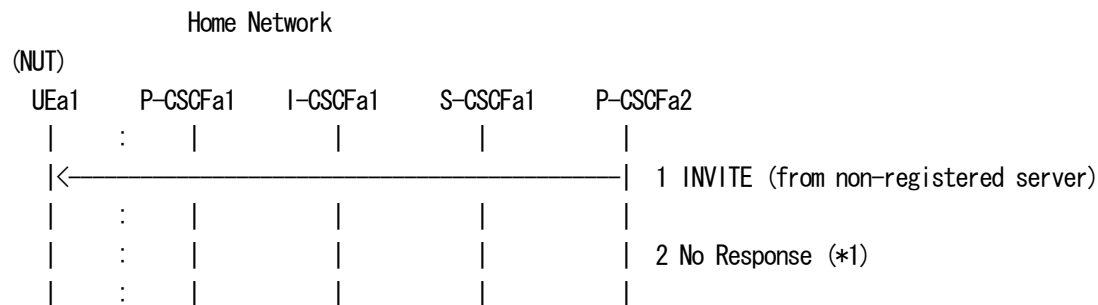

1 NUT receives INVITE



==== Message example ====

1. INVITE P-CSCFa2 -> NUT

```
INVITE sip:UEa1_public_1@node.under.test.com:1357 SIP/2.0
Via: SIP/2.0/UDP p.a2.under.test.com;branch=z9hG4bK4412,
SIP/2.0/UDP [3ffe:501:ffff:2000::1000]:22222;branch=z9hG4bK08b4
Record-Route: <sip:p.a2.under.test.com;lr>
Max-Forwards: 69
From: <sip:UEa2_public_1@under.test.com>;tag=10fxced76sl
To: <sip:UEa1_public_1@under.test.com>
Call-ID: 3848276298220188511@under.test.com
CSeq: 1 INVITE
Contact: <sip:UEa2_public_1@nodea2.under.test.com:22222>
Supported:
Allow: INVITE,ACK,CANCEL,OPTIONS,BYE
Allow-Events: reg
Accept: application/sdp,application/3gpp-ims+xml
P-Called-Party-ID: <sip:UEa1_public_1@under.test.com>
Content-Type: application/sdp
Content-Length: 154
```

```
v=0
o=UEa2 3490499303 3490499303 IN IP6 nodea2.under.test.com
s=-
c=IN IP6 nodea2.under.test.com
t=0 0
m=audio 49172 RTP/AVP 0
b=AS:75
a=rtpmap:0 PCMU/8000
```

[OBSERVABLE RESULTS]

*1 : 2. No response

The UE SHALL discard any SIP request that is not protected by the security association and is received from the P-CSCF outside of the registration and authentication procedures.[TS24229-5.1-426]

4.2.9 UE-SE-B-9-AKA - Receiving 503 response to INVITE



[NAME]

UE-SE-B-9-AKA - Receiving 503 response to INVITE

[TARGET]

IMS User Equipment (NUT)

[PURPOSE]

To verify that the UEa1 properly receives a response 503 and retry INVITE after 30 seconds.

[REFERENCE]

TS24229 5.1.3.1

[PARAMETER(NUT)]

public-user-id : sip:UEa1_public_1@under.test.com
private-user-id : UEa1_private@under.test.com
contact_URI : sip:UEa1_public_1@node.under.test.com
HOMENETWORK Domain : sip:under.test.com

[PARAMETER(TESTER)]

public-user-id(UEa2) : sip:UEa2_public_1@under.test.com
P-CSCFa1 : sip:p.a1.under.test.com

[ADDRESS]

UEa1(NUT) : 3ffe:501:ffff:1000::1000
Router(R1) : 3ffe:501:ffff:1000::1
P-CSCFa1 : 3ffe:501:ffff:100::10
I-CSCFa1 : 3ffe:501:ffff:100::20
S-CSCFa1 : 3ffe:501:ffff:100::30
DNS : 3ffe:501:ffff:100::40
DHCP : 3ffe:501:ffff:100::50

UEa2 : 3ffe:501:ffff:2000::1000
P-CSCFa2 : 3ffe:501:ffff:200::10
I-CSCFa2 : 3ffe:501:ffff:200::20
S-CSCFa2 : 3ffe:501:ffff:200::30

[TOPOLOGY]

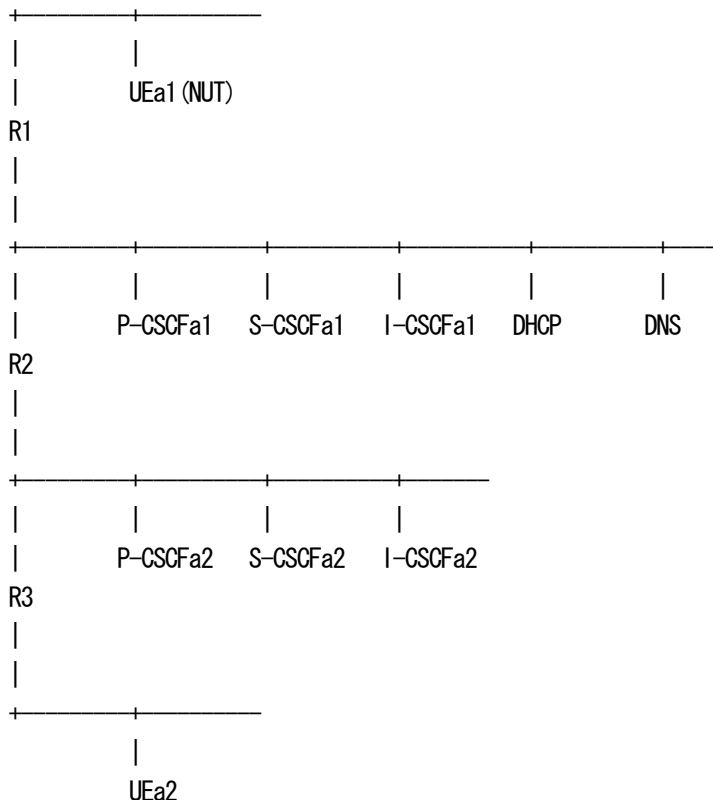

[INITIALIZATION]

UEa1(NUT) must be registered with the tester by executing the scenario "UE-INI-B-1-AKA".
 For details of "UE-INI-B-1-AKA", refer to the profile "UE-RG-B-1-AKA".

[PROCEDURE]

Home Network

(NUT)

UEa1	P-CSCFa1	S-CSCFa1	I-CSCFa1	I-CSCFa2	S-CSCFa2	P-CSCFa2	UEa2
	:						
	:						
	→						1 INVITE
	:						
	:						INVITE
	:						
	←						2 100 Trying
	:						
	:						503 Service Unavailable

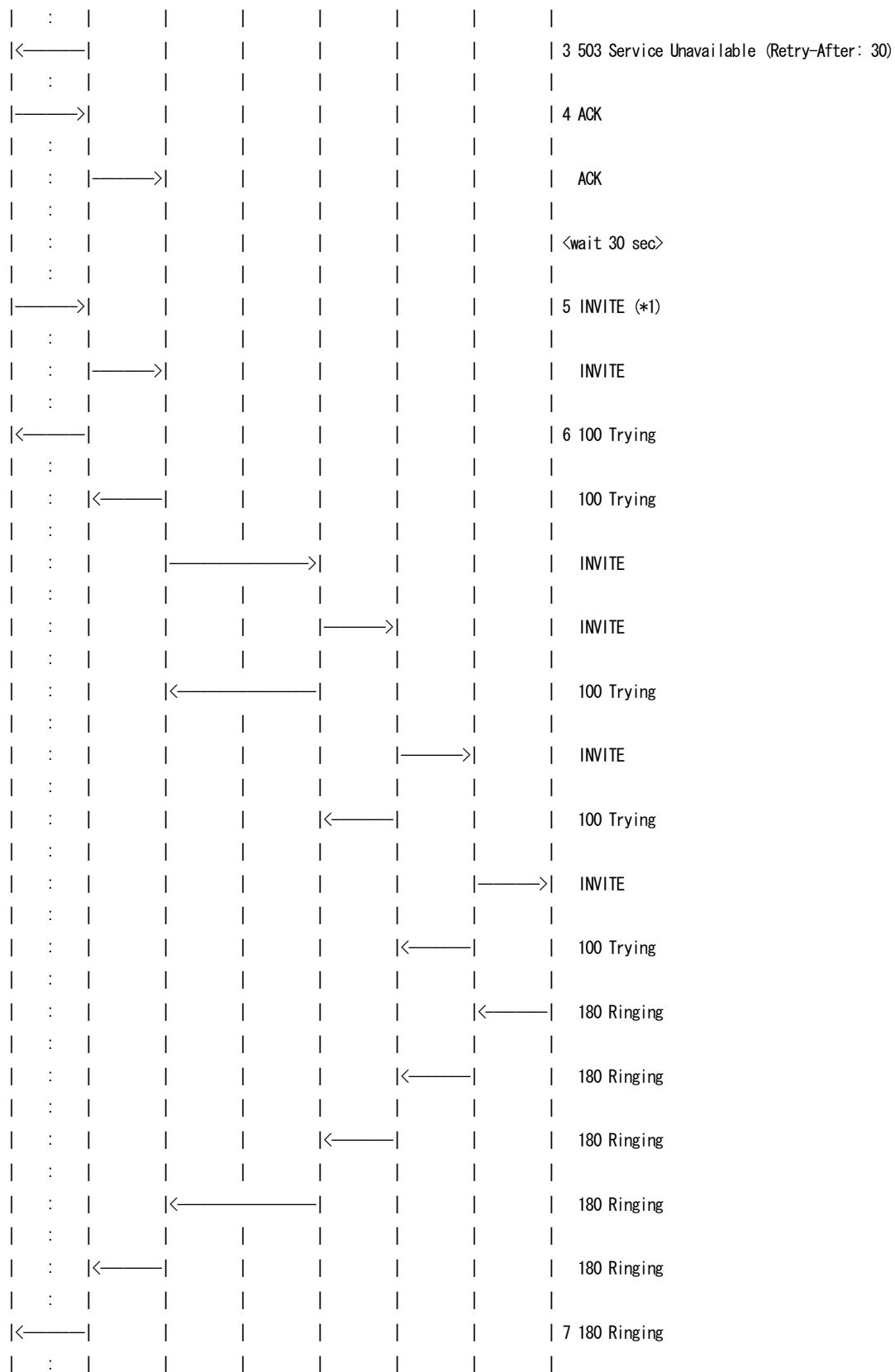

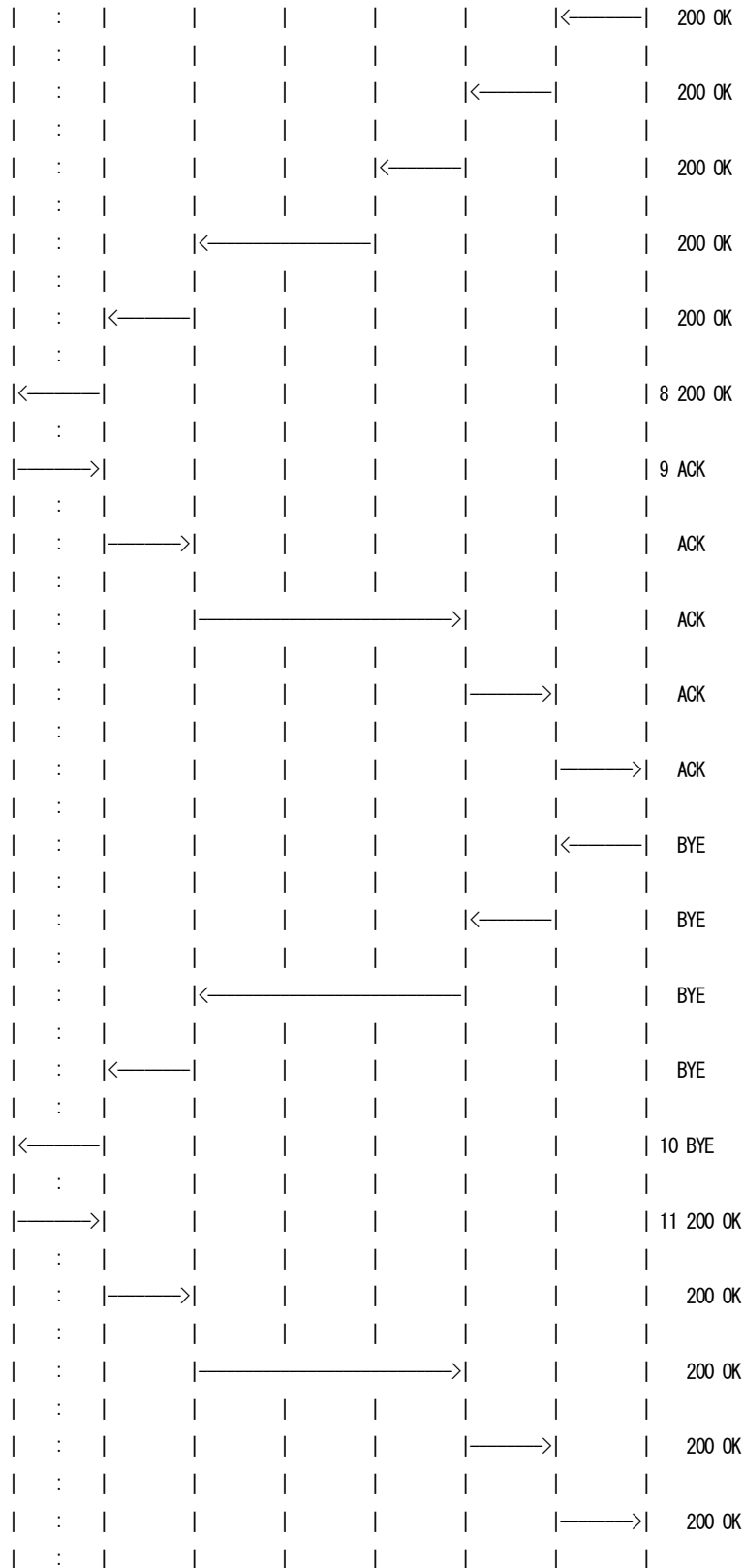



1 NUT sends INVITE
2 NUT receives 100 Trying
3 NUT receives 503
4 NUT sends ACK
5 NUT sends INVITE
6 NUT receives 100 Trying
7 NUT receives 180 Ringing
8 NUT receives 200 OK
9 NUT sends ACK
10 NUT receives BYE
11 NUT sends 200 OK

==== Message example ====

1. INVITE NUT -> P-CSCF

INVITE sip:UEa2_public_1@under.test.com SIP/2.0

Via: SIP/2.0/UDP [3ffe:501:ffff:1000::1000]:1357;branch=z9hG4bK74bf9

Route: <sip:p.a1.under.test.com:10001;lr>, <sip:orig@s.a1.under.test.com;lr>

Max-Forwards: 70

From: <sip:UEa1_public_1@under.test.com>;tag=9fxced76sl

To: <sip:UEa2_public_1@under.test.com>

Call-ID: 3848276298220188511@under.test.com

CSeq: 1 INVITE

Contact: <sip:UEa1_public_1@node.under.test.com:1357>

Supported:

Allow: INVITE,ACK,CANCEL,OPTIONS,BYE

Allow-Events: reg

Accept: application/sdp,application/3gpp-ims+xml

Require: sec-agree

Proxy-Require: sec-agree

Security-Verify: ipsec-3gpp; alg=hmac-sha-1-96; spi-c=256; spi-s=257; port-c=10002; port-s=10001

Content-Type: application/sdp

Content-Length: 154

v=0

o=UEa1 2890844526 2890844526 IN IP6 node.under.test.com

s=-

c=IN IP6 node.under.test.com

t=0 0

m=audio 49172 RTP/AVP 0

b=AS:75

a=rtpmap:0 PCMU/8000



2. 100 Trying P-CSCF -> NUT

SIP/2.0 100 Trying

Via: SIP/2.0/UDP [3ffe:501:ffff:1000::1000]:1357;branch=z9hG4bK74bf9

From: <sip:UEa1_public_1@under.test.com>;tag=9fxced76sl

To: <sip:UEa2_public_1@under.test.com>

Call-ID: 3848276298220188511@under.test.com

CSeq: 1 INVITE

Content-Length: 0

3. 503 Service Unavailable P-CSCF -> NUT

SIP/2.0 503 Service Unavailable

Via: SIP/2.0/UDP [3ffe:501:ffff:1000::1000]:1357;branch=z9hG4bK74bf9

From: <sip:UEa1_public_1@under.test.com>;tag=9fxced76sl

To: <sip:UEa2_public_1@under.test.com>;tag=314259

Call-ID: 3848276298220188511@under.test.com

CSeq: 1 INVITE

Retry-After: 30

Content-Length: 0

4. ACK NUT -> P-CSCF

ACK sip:UEa2_public_1@under.test.com SIP/2.0

Via: SIP/2.0/UDP [3ffe:501:ffff:1000::1000]:1357;branch=z9hG4bK74bf9

Route: <sip:p.a1.under.test.com:10001;lr>,<sip:orig@s.a1.under.test.com;lr>

Max-Forwards: 70

From: <sip:UEa1_public_1@under.test.com>;tag=9fxced76sl

To: <sip:UEa2_public_1@under.test.com>;tag=314259

Call-ID: 3848276298220188511@under.test.com

CSeq: 1 ACK

Content-Length: 0

5. INVITE NUT -> P-CSCF

INVITE sip:UEa2_public_1@under.test.com SIP/2.0

Via: SIP/2.0/UDP [3ffe:501:ffff:1000::1000]:1357;branch=z9hG4bK74bf9

Route: <sip:p.a1.under.test.com:10001;lr>,<sip:orig@s.a1.under.test.com;lr>

Max-Forwards: 70

From: <sip:UEa1_public_1@under.test.com>;tag=9fxced76sl

To: <sip:UEa2_public_1@under.test.com>

Call-ID: 3848276298220188511@under.test.com



CSeq: 1 INVITE
Contact: <sip:UEa1_public_1@node.under.test.com:1357>
Supported:
Allow: INVITE,ACK,CANCEL,OPTIONS,BYE
Allow-Events: reg
Accept: application/sdp,application/3gpp-ims+xml
Require: sec-agree
Proxy-Require: sec-agree
Security-Verify: ipsec-3gpp; alg=hmac-sha-1-96; spi-c=256; spi-s=257; port-c=10002; port-s=10001
Content-Type: application/sdp
Content-Length: 154

v=0
o=UEa1 2890844526 2890844526 IN IP6 node.under.test.com
s=-
c=IN IP6 node.under.test.com
t=0 0
m=audio 49172 RTP/AVP 0
b=AS:75
a=rtpmap:0 PCMU/8000

6. 100 Trying P-CSCF -> NUT
SIP/2.0 100 Trying
Via: SIP/2.0/UDP [3ffe:501:ffff:1000::1000]:1357;branch=z9hG4bK74bf9
From: <sip:UEa1_public_1@under.test.com>;tag=9fxced76sl
To: <sip:UEa2_public_1@under.test.com>
Call-ID: 3848276298220188511@under.test.com
CSeq: 1 INVITE
Content-Length: 0

7. 180 Ringing P-CSCF -> NUT
SIP/2.0 180 Ringing
Via: SIP/2.0/UDP [3ffe:501:ffff:1000::1000]:1357;branch=z9hG4bK74bf9
From: <sip:UEa1_public_1@under.test.com>;tag=9fxced76sl
To: <sip:UEa2_public_1@under.test.com>;tag=314259
Call-ID: 3848276298220188511@under.test.com
CSeq: 1 INVITE
Content-Length: 0

8. 200 OK P-CSCF -> NUT



SIP/2.0 200 OK
Via: SIP/2.0/UDP [3ffe:501:ffff:1000::1000]:1357;branch=z9hG4bK74bf9
Record-Route: <sip:p.a2.under.test.com;lr>,<sip:s.a2.under.test.com;lr>,<sip:s.a1.under.test.com;lr>,<sip:p.a1.under.test.com:10001;lr>
From: <sip:UEa1_public_1@under.test.com>;tag=9fxced76sl
To: <sip:UEa2_public_1@under.test.com>;tag=314259
Call-ID: 3848276298220188511@under.test.com
CSeq: 1 INVITE
Contact: <sip:UEa2_public_1@nodea2.under.test.com:22222>
Supported:
Allow: INVITE,ACK,CANCEL,OPTIONS,BYE
Allow-Events: reg
Content-Type: application/sdp
Content-Length: 153

v=0
o=UEa2 2890844527 2890844527 IN IP6 nodea2.under.test.com
s=-
c=IN IP6 nodea2.under.test.com
t=0 0
m=audio 3456 RTP/AVP 0
b=AS:75
a=rtpmap:0 PCMU/8000

9. ACK NUT -> P-CSCF

ACK sip:UEa2_public_1@nodea2.under.test.com:22222 SIP/2.0
Via: SIP/2.0/UDP [3ffe:501:ffff:1000::1000]:1357;branch=z9hG4bK74bf10
Route: <sip:p.a1.under.test.com:10001;lr>,<sip:s.a1.under.test.com;lr>,<sip:s.a2.under.test.com;lr>,<sip:p.a2.under.test.com;lr>
Max-Forwards: 70
From: <sip:UEa1_public_1@under.test.com>;tag=9fxced76sl
To: <sip:UEa2_public_1@under.test.com>;tag=314259
Call-ID: 3848276298220188511@under.test.com
CSeq: 1 ACK
Content-Length: 0

10. BYE P-CSCF -> NUT

BYE sip:UEa1_public_1@node.under.test.com:1357 SIP/2.0
Via: SIP/2.0/UDP p.a1.under.test.com:10001;branch=z9hG4bK431e418c501,
SIP/2.0/UDP s.a1.under.test.com;branch=z9hG4bKnashdsa2.3;received=3ffe:501:ffff:100::30,
SIP/2.0/UDP s.a2.under.test.com;branch=z9hG4bK721e418c9.1;received=3ffe:501:ffff:200::30,



SIP/2.0/UDP p.a2.under.test.com;branch=z9hG4bKnaghds30;received=3ffe:501:ffff:200::10,
SIP/2.0/UDP [3ffe:501:ffff:2000::1000];22222;branch=z9hG4bKnashdsb3
Max-Forwards: 66
From: <sip:UEa2_public_1@under.test.com>;tag=314259
To: <sip:UEa1_public_1@under.test.com>;tag=9fxced76sl
Call-ID: 3848276298220188511@under.test.com
CSeq: 2 BYE
Content-Length: 0

11. 200 OK NUT -> P-CSCF

SIP/2.0 200 OK

Via: SIP/2.0/UDP p.a1.under.test.com:10001;branch=z9hG4bK431e418c501;
received=3ffe:501:ffff:100::10,SIP/2.0/UDP s.a1.under.test.com;branch=z9hG4bKnashdsa2.3;
received=3ffe:501:ffff:100::30,SIP/2.0/UDP s.a2.under.test.com;branch=z9hG4bK721e418c9.1;
received=3ffe:501:ffff:200::30,SIP/2.0/UDP p.a2.under.test.com;branch=z9hG4bKnaghds30;
received=3ffe:501:ffff:200::10,SIP/2.0/UDP [3ffe:501:ffff:2000::1000];22222;branch=z9hG4bKnashdsb3
From: <sip:UEa2_public_1@under.test.com>;tag=314259
To: <sip:UEa1_public_1@under.test.com>;tag=9fxced76sl
Call-ID: 3848276298220188511@under.test.com
CSeq: 2 BYE
Content-Length: 0

[OBSERVABLE RESULTS]

*1: 5 INVITE from NUT to P-CSCF.

See generic_INVITE

The request SHALL not be automatically sent until after the period
indicated by the Retry-After header feild.[TS24229-5.1-474]

4.2.10 UE-SE-B-10-AKA - Receiving forked 180 and 200 response

[NAME]

UE-SE-B-10-AKA - Receiving forked 180 and 200 response

[TARGET]

IMS User Equipment (NUT)



[PURPOSE]

(1) To verify that UEa1 properly receives forked 180(Ringing) and 200(OK) responses.

(2) To verify that UEa1 properly sends BYE to UEa3.

[REFERENCE]

TS24.229 5.1.3.1

[REQUIREMENT]

NONE

[PARAMETER(NUT)]

public-user-id : sip:UEa1_public_1@under.test.com
private-user-id : UEa1_private@under.test.com
contact_URI : sip:UEa1_public_1@node.under.test.com
HOMENETWORK Domain : sip.under.test.com

[PARAMETER(TESTER)]

public-user-id(UEa2) : sip:UEa2_public_1@under.test.com
P-CSCFa1 : sip:p.a1.under.test.com

[ADDRESS]

UEa1(NUT) : 3ffe:501:fff:1000::1000
Router(R1) : 3ffe:501:fff:1000::1
P-CSCFa1 : 3ffe:501:fff:100::10
I-CSCFa1 : 3ffe:501:fff:100::20
S-CSCFa1 : 3ffe:501:fff:100::30
DNS : 3ffe:501:fff:100::40
DHCP : 3ffe:501:fff:100::50

UEa2 : 3ffe:501:fff:2000::1000
P-CSCFa2 : 3ffe:501:fff:200::10
I-CSCFa2 : 3ffe:501:fff:200::20
S-CSCFa2 : 3ffe:501:fff:200::30
UEa3 : 3ffe:501:fff:2000::1001

[TOPOLOGY]

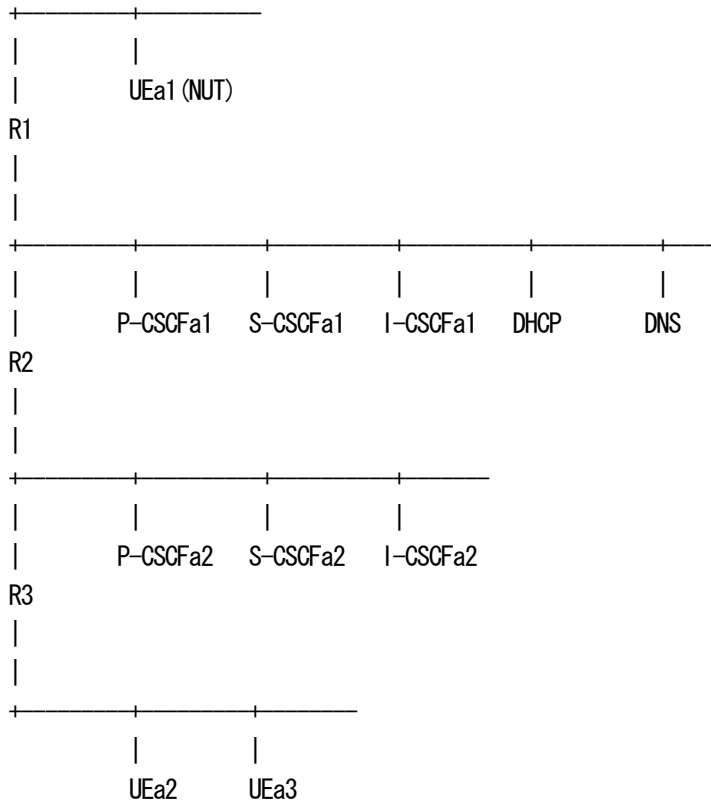

[INITIALIZATION]

UEa1(NUT) must be registered with the tester by executing the scenario "UE-INI-B-1-AKA".
For details of "UE-INI-B-1-AKA", refer to the profile "UE-RG-B-1-AKA".

[PROCEDURE]

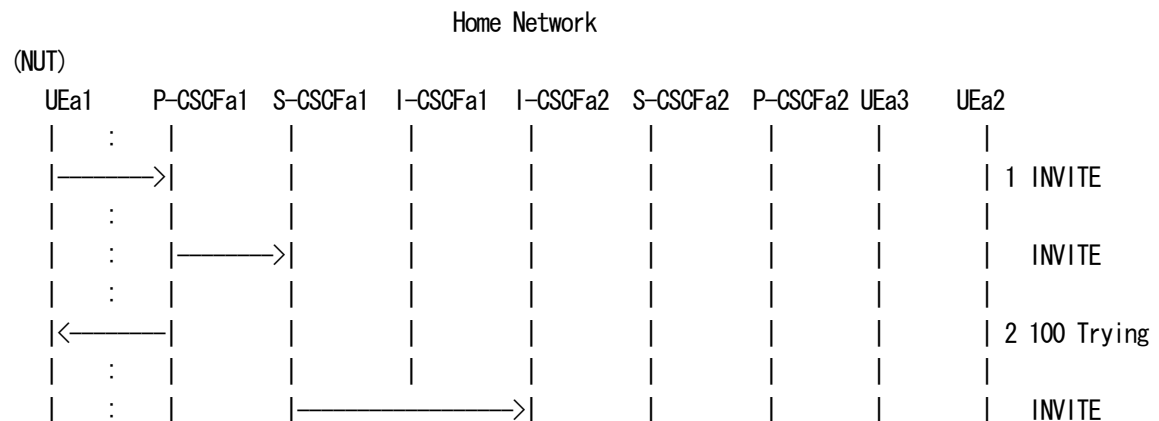

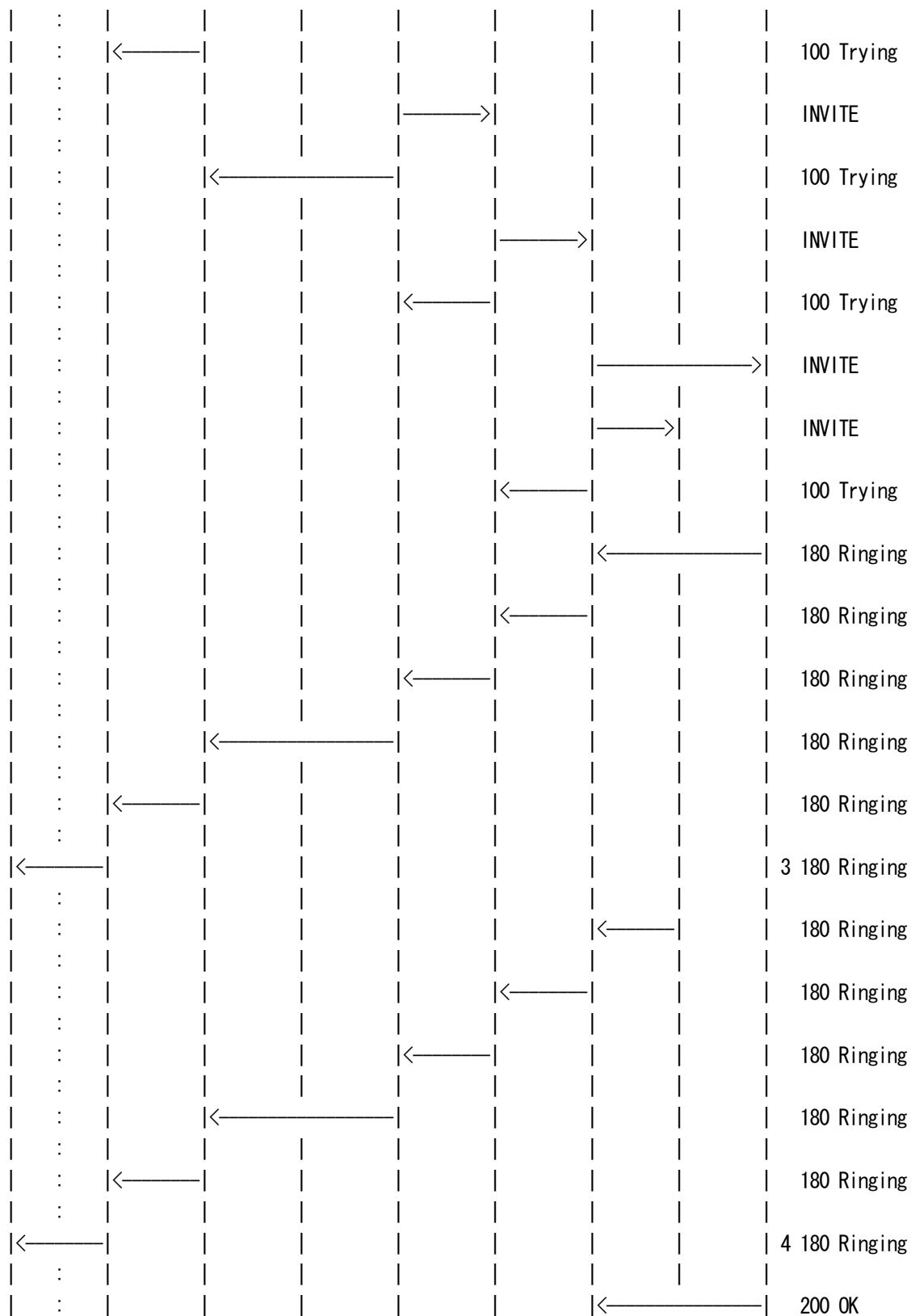

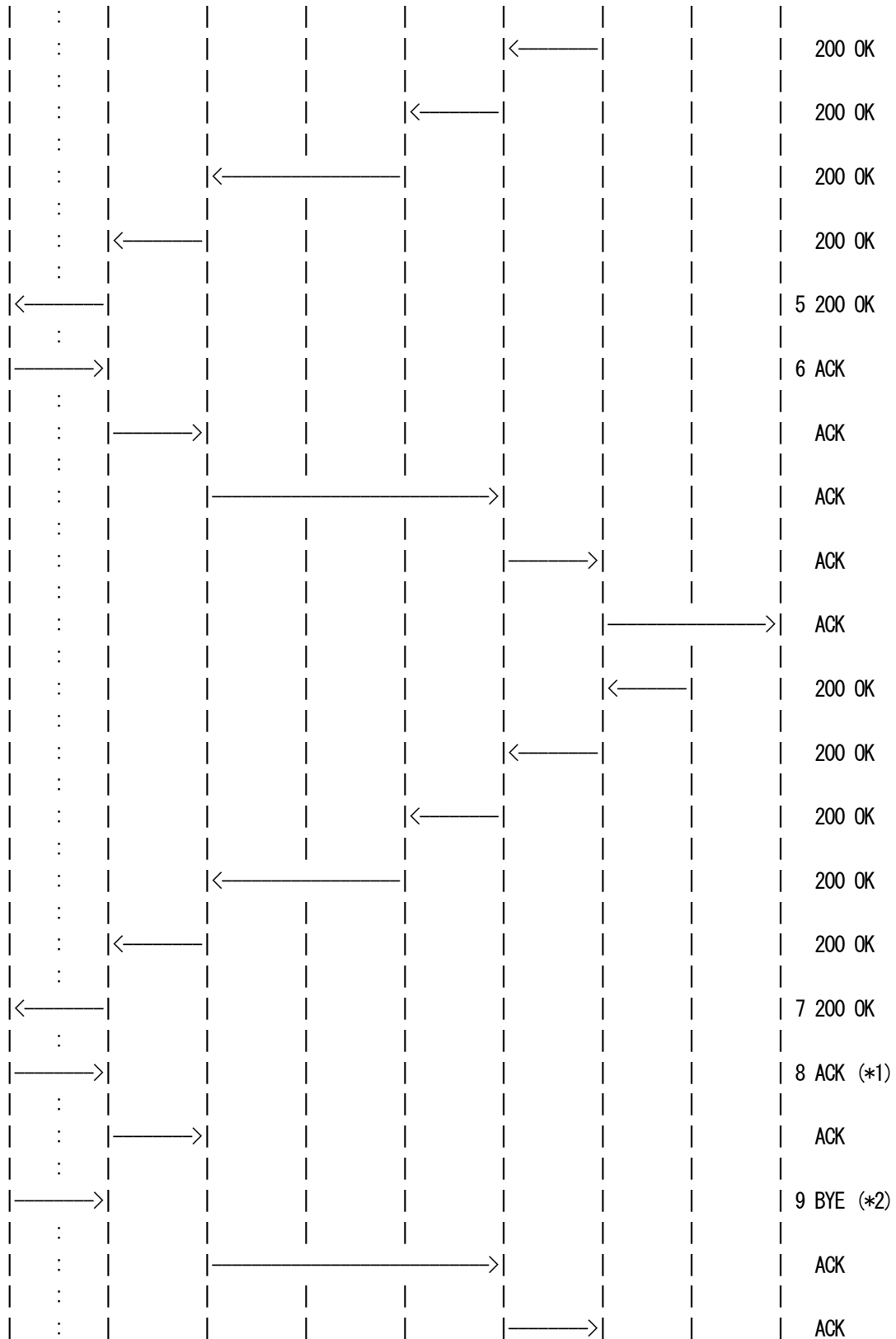

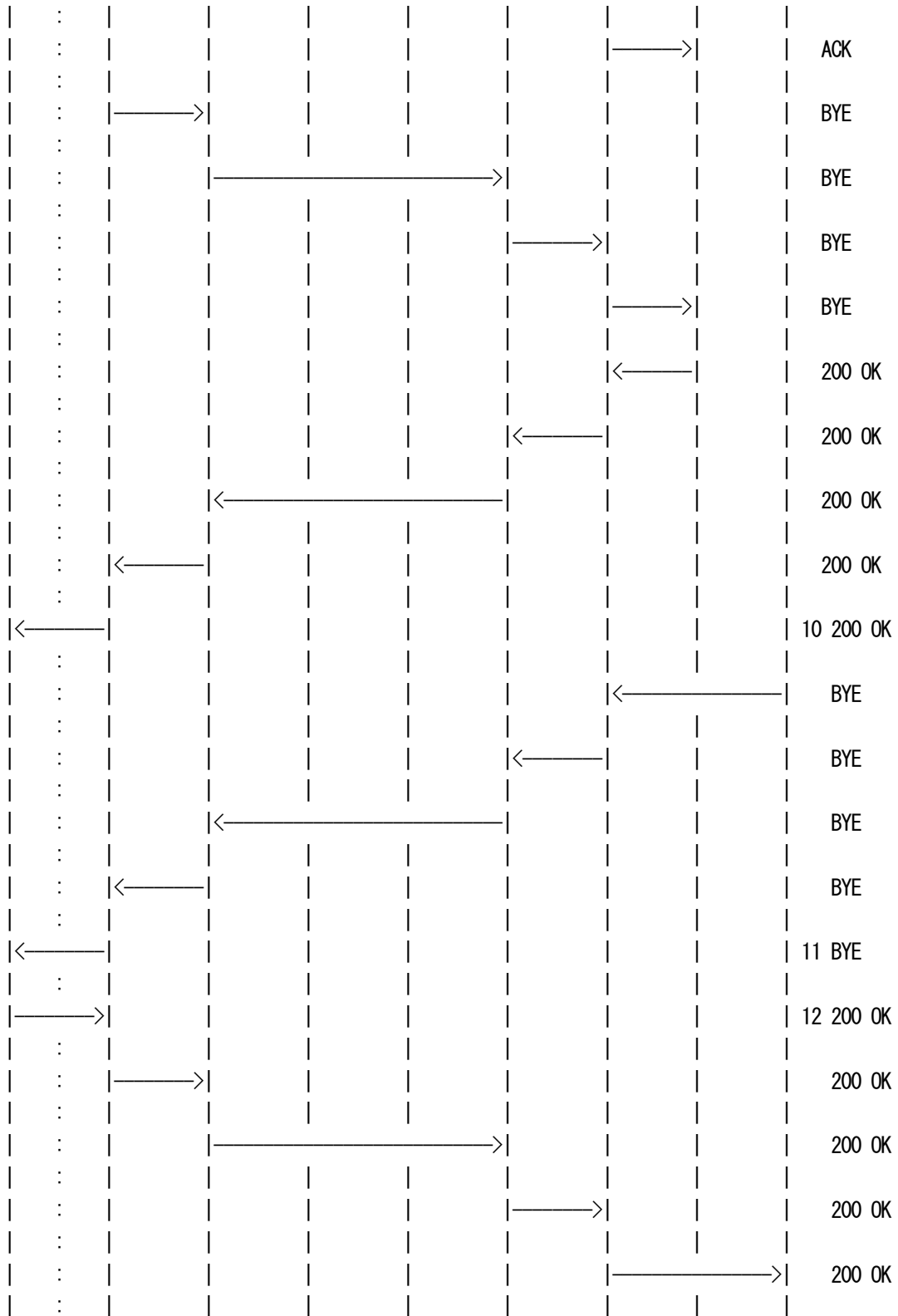

1 NUT sends INVITE



2 NUT receives 100 Trying
3 NUT receives 180 Ringing
4 NUT receives 180 Ringing
5 NUT receives 200 OK
6 NUT sends ACK
7 NUT receives 200 OK
8 NUT sends ACK
9 NUT sends BYE
10 NUT sends 200 OK
11 NUT receives BYE
12 NUT sends 200 OK

==== Message example ====

1. INVITE NUT -> P-CSCF

INVITE sip:UEa2_public_1@under.test.com SIP/2.0

Via: SIP/2.0/UDP [3ffe:501:ffff:1000::1000]:1357;branch=z9hG4bK74bf9

Route: <sip:p.a1.under.test.com:10001;lr>, <sip:orig@s.a1.under.test.com;lr>

Max-Forwards: 70

From: <sip:UEa1_public_1@under.test.com>;tag=9fxced76sl

To: <sip:UEa2_public_1@under.test.com>

Call-ID: 3848276298220188511@under.test.com

CSeq: 1 INVITE

Contact: <sip:UEa1_public_1@node.under.test.com:1357>

Supported:

Allow: INVITE,ACK,CANCEL,OPTIONS,BYE

Allow-Events: reg

Accept: application/sdp,application/3gpp-ims+xml

Require: sec-agree

Proxy-Require: sec-agree

Security-Verify: ipsec-3gpp; alg=hmac-sha-1-96; spi-c=256; spi-s=257; port-c=10002; port-s=10001

Content-Type: application/sdp

Content-Length: 154

v=0

o=UEa1 2890844526 2890844526 IN IP6 node.under.test.com

s=-

c=IN IP6 node.under.test.com

t=0 0

m=audio 49172 RTP/AVP 0

b=AS:75

a=rtpmap:0 PCMU/8000



2. 100 Trying P-CSCF -> NUT

SIP/2.0 100 Trying

Via: SIP/2.0/UDP [3ffe:501:ffff:1000::1000]:1357;branch=z9hG4bK74bf9

From: <sip:UEa1_public_1@under.test.com>;tag=9fxced76sl

To: <sip:UEa2_public_1@under.test.com>

Call-ID: 3848276298220188511@under.test.com

CSeq: 1 INVITE

Content-Length: 0

3. 180 Ringing P-CSCF -> NUT

SIP/2.0 180 Ringing

Via: SIP/2.0/UDP [3ffe:501:ffff:1000::1000]:1357;branch=z9hG4bK74bf9

From: <sip:UEa1_public_1@under.test.com>;tag=9fxced76sl

To: <sip:UEa2_public_1@under.test.com>;tag=314259

Call-ID: 3848276298220188511@under.test.com

CSeq: 1 INVITE

Content-Length: 0

4. 180 Ringing P-CSCF -> NUT

SIP/2.0 180 Ringing

Via: SIP/2.0/UDP [3ffe:501:ffff:1000::1000]:1357;branch=z9hG4bK74bf9

From: <sip:UEa1_public_1@under.test.com>;tag=9fxced76sl

To: <sip:UEa2_public_1@under.test.com>;tag=314223

Call-ID: 3848276298220188511@under.test.com

CSeq: 1 INVITE

Content-Length: 0

5. 200 OK P-CSCF -> NUT

SIP/2.0 200 OK

Via: SIP/2.0/UDP [3ffe:501:ffff:1000::1000]:1357;branch=z9hG4bK74bf9

Record-Route: <sip:p.a2.under.test.com;lr>,<sip:s.a2.under.test.com;lr>,<sip:s.a1.under.test.com;lr>,<sip:p.a1.under.test.com:10001;lr>

From: <sip:UEa1_public_1@under.test.com>;tag=9fxced76sl

To: <sip:UEa2_public_1@under.test.com>;tag=314259

Call-ID: 3848276298220188511@under.test.com

CSeq: 1 INVITE

Contact: <sip:UEa2_public_1@nodea2.under.test.com:22222>

Supported:



Allow: INVITE,ACK,CANCEL,OPTIONS,BYE

Allow-Events: reg

Content-Type: application/sdp

Content-Length: 153

v=0

o=UEa2 2890844527 2890844527 IN IP6 nodea2.under.test.com

s=-

c=IN IP6 nodea2.under.test.com

t=0 0

m=audio 3456 RTP/AVP 0

b=AS:75

a=rtpmap:0 PCMU/8000

6. ACK NUT -> P-CSCF

ACK sip:UEa2_public_1@nodea2.under.test.com:22222 SIP/2.0

Via: SIP/2.0/UDP [3ffe:501:ffff:1000::1000]:1357;branch=z9hG4bK74bf10

Route: <sip:p.a1.under.test.com:10001;lr>,<sip:s.a1.under.test.com;lr>,
<sip:s.a2.under.test.com;lr>,<sip:p.a2.under.test.com;lr>

Max-Forwards: 70

From: <sip:UEa1_public_1@under.test.com>;tag=9fxced76sl

To: <sip:UEa2_public_1@under.test.com>;tag=314259

Call-ID: 3848276298220188511@under.test.com

CSeq: 1 ACK

Content-Length: 0

7. 200 OK P-CSCF -> NUT

SIP/2.0 200 OK

Via: SIP/2.0/UDP [3ffe:501:ffff:1000::1000]:1357;branch=z9hG4bK74bf9

Record-Route: <sip:p.a2.under.test.com;lr>,<sip:s.a2.under.test.com;lr>,
<sip:s.a1.under.test.com;lr>,<sip:p.a1.under.test.com:10001;lr>

From: <sip:UEa1_public_1@under.test.com>;tag=9fxced76sl

To: <sip:UEa2_public_1@under.test.com>;tag=314223

Call-ID: 3848276298220188511@under.test.com

CSeq: 1 INVITE

Contact: <sip:UEa3_public_1@nodea2.under.test.com:22222>

Supported:

Allow: INVITE,ACK,CANCEL,OPTIONS,BYE

Allow-Events: reg

Content-Type: application/sdp

Content-Length: 153



v=0
o=UEa3 2890844527 2890844527 IN IP6 nodea2.under.test.com
s=-
c=IN IP6 nodea2.under.test.com
t=0 0
m=audio 3456 RTP/AVP 0
b=AS:75
a=rtpmap:0 PCMU/8000

8. ACK NUT -> P-CSCF

ACK sip:UEa3_public_1@nodea2.under.test.com:22222 SIP/2.0
Via: SIP/2.0/UDP [3ffe:501:ffff:1000::1000]:1357;branch=z9hG4bK74bf10
Route: <sip:p.a1.under.test.com:10001;lr>,<sip:s.a1.under.test.com;lr>,
<sip:s.a2.under.test.com;lr>,<sip:p.a2.under.test.com;lr>
Max-Forwards: 70
From: <sip:UEa1_public_1@under.test.com>;tag=9fxced76sl
To: <sip:UEa2_public_1@under.test.com>;tag=314223
Call-ID: 3848276298220188511@under.test.com
CSeq: 1 ACK
Content-Length: 0

9. BYE NUT -> P-CSCF

BYE sip:UEa3_public_1@nodea2.under.test.com:22222 SIP/2.0
Via: SIP/2.0/UDP [3ffe:501:ffff:1000::1000]:1357;branch=z9hG4bK74bf11
Route: <sip:p.a1.under.test.com:10001;lr>,<sip:s.a1.under.test.com;lr>,
<sip:s.a2.under.test.com;lr>,<sip:p.a2.under.test.com;lr>
Max-Forwards: 70
From: <sip:UEa1_public_1@under.test.com>;tag=9fxced76sl
To: <sip:UEa2_public_1@under.test.com>;tag=314223
Call-ID: 3848276298220188511@under.test.com
CSeq: 2 BYE
Content-Length: 0
Security-Verify: ipsec-3gpp; alg=hmac-sha-1-96; spi-c=256; spi-s=257; port-c=10002; port-s=10001
Require: sec-agree
Proxy-Require: sec-agree

10. 200 OK P-CSCF -> NUT

SIP/2.0 200 OK
Via: SIP/2.0/UDP [3ffe:501:ffff:1000::1000]:1357;branch=z9hG4bK74bf11



From: <sip:UEa1_public_1@under.test.com>;tag=9fxced76sl
To: <sip:UEa2_public_1@under.test.com>;tag=314223
Call-ID: 3848276298220188511@under.test.com
CSeq: 2 BYE
Content-Length: 0

11. BYE P-CSCF -> NUT

BYE sip:UEa1_public_1@node.under.test.com:1357 SIP/2.0
Via: SIP/2.0/UDP p.a1.under.test.com:10001;branch=z9hG4bK431e418c501,
SIP/2.0/UDP s.a1.under.test.com;branch=z9hG4bKnashdsa2.3;received=3ffe:501:ffff:100::30,
SIP/2.0/UDP s.a2.under.test.com;branch=z9hG4bK721e418c9.1;received=3ffe:501:ffff:200::30,
SIP/2.0/UDP p.a2.under.test.com;branch=z9hG4bKnaghds30;received=3ffe:501:ffff:200::10,
SIP/2.0/UDP [3ffe:501:ffff:2000::1000]:22222;branch=z9hG4bKnashdsb3
Max-Forwards: 66
From: <sip:UEa2_public_1@under.test.com>;tag=314259
To: <sip:UEa1_public_1@under.test.com>;tag=9fxced76sl
Call-ID: 3848276298220188511@under.test.com
CSeq: 3 BYE
Content-Length: 0

12. 200 OK NUT -> P-CSCF

SIP/2.0 200 OK
Via: SIP/2.0/UDP p.a1.under.test.com:10001;branch=z9hG4bK431e418c501;
received=3ffe:501:ffff:100::10,SIP/2.0/UDP s.a1.under.test.com;branch=z9hG4bKnashdsa2.3;
received=3ffe:501:ffff:100::30,SIP/2.0/UDP s.a2.under.test.com;branch=z9hG4bK721e418c9.1;
received=3ffe:501:ffff:200::30,SIP/2.0/UDP p.a2.under.test.com;branch=z9hG4bKnaghds30;
received=3ffe:501:ffff:200::10,SIP/2.0/UDP [3ffe:501:ffff:2000::1000]:22222;branch=z9hG4bKnashdsb3
From: <sip:UEa2_public_1@under.test.com>;tag=314259
To: <sip:UEa1_public_1@under.test.com>;tag=9fxced76sl
Call-ID: 3848276298220188511@under.test.com
CSeq: 3 BYE
Content-Length: 0

[OBSERVABLE RESULTS]

*1: 8 ACK from NUT to P-CSCF

See generic_ACK

The UE SHALL acknowledge the response with an ACK request.[TS24229-5.1-468]



The UAC core MUST generate an ACK request for each 2xx received from the transaction layer.[RFC3261-13.2-18]

*2: 9 BYE from NUT to P-CSCF

See generic_BYE

The UE SHALL send a BYE request to this dialog in order to terminate it.
[TS24229-5.1-469]

4.3 SDP

4.3.1 UE-SD-B-1-AKA - SDP offer which included one or more media lines which was offered with several codecs (Receives INVITE and sends BYE)

[NAME]

UE-SD-B-1-AKA - SDP offer which included one or more media lines which was offered with several codecs (Receives INVITE and sends BYE)

[TARGET]

IMS User Equipment (NUT)

[PURPOSE]

To verify that the UEa1 properly process an INVITE with a SDP offer which included one or more media lines which was offered with several codecs, and responds with a 200 (OK) response included proper SDP selecting exactly one codec per payload and indicate only the selected codec for the related media stream.

[REFERENCE]

TS24.229 6.1.3

[REQUIREMENT]

NONE

[PARAMETER(NUT)]



public-user-id : sip:UEa1_public_1@under.test.com
private-user-id : UEa1_private@under.test.com
contact_URI : sip:UEa1_public_1@node.under.test.com
HOMENETWORK Domain : sip:under.test.com

[PARAMETER(TESTER)]

public-user-id(UEa2) : sip:UEa2_public_1@under.test.com
P-CSCFa1 : sip:p.a1.under.test.com

[ADDRESS]

UEa1(NUT) : 3ffe:501:fff:1000::1000
Router(R1) : 3ffe:501:fff:1000::1
P-CSCFa1 : 3ffe:501:fff:100::10
I-CSCFa1 : 3ffe:501:fff:100::20
S-CSCFa1 : 3ffe:501:fff:100::30
DNS : 3ffe:501:fff:100::40
DHCP : 3ffe:501:fff:100::50

UEa2 : 3ffe:501:fff:2000::1000
P-CSCFa2 : 3ffe:501:fff:200::10
I-CSCFa2 : 3ffe:501:fff:200::20
S-CSCFa2 : 3ffe:501:fff:200::30

[TOPOLOGY]

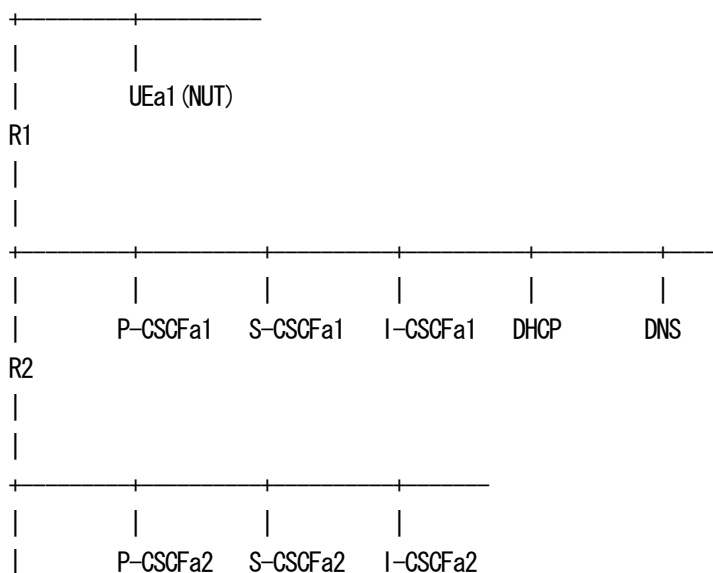

R3

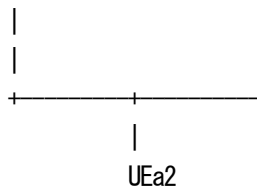

[INITIALIZATION]

UEa1(NUT) must be registered with the tester by executing the scenario "UE-INI-B-1-AKA".

For details of "UE-INI-B-1-AKA", refer to the profile "UE-RG-B-1-AKA".

[PROCEDURE]

Home Network

(NUT)

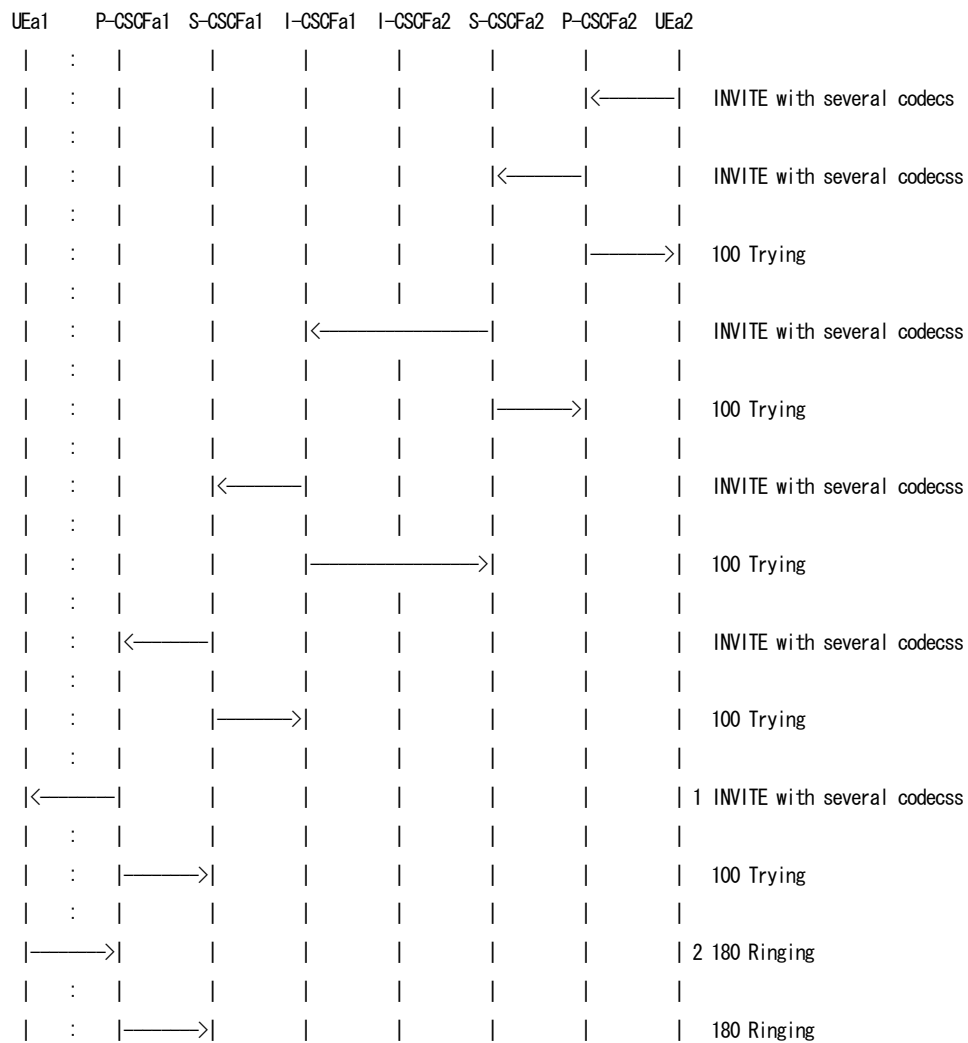

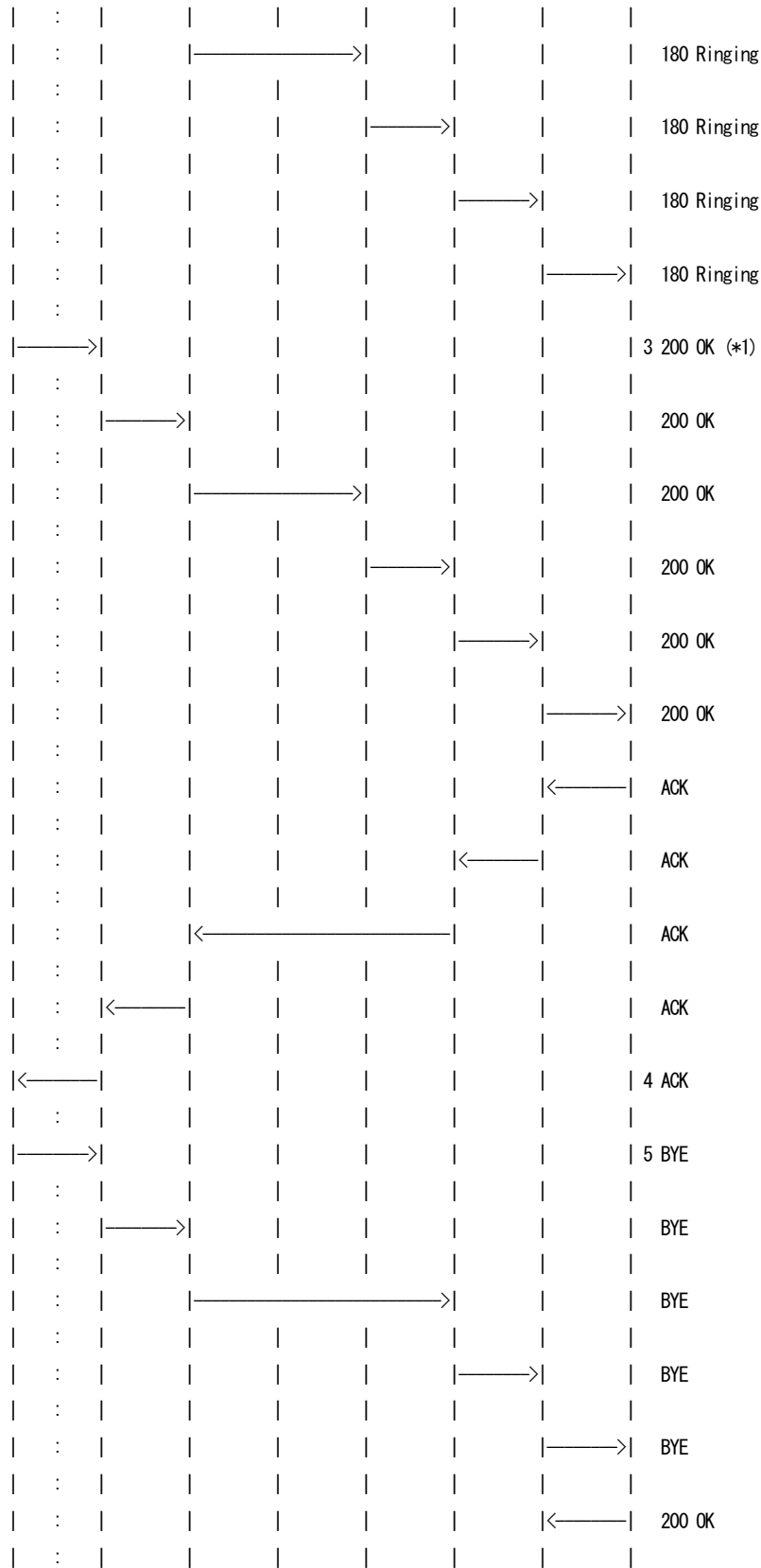

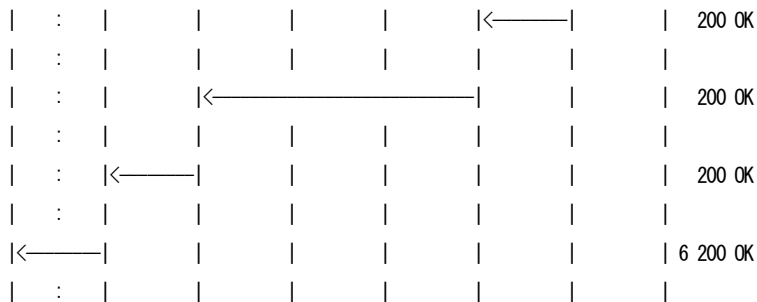

- 1 NUT receives INVITE
- 2 NUT sends 180 Ringing
- 3 NUT sends 200 OK
- 4 NUT receives ACK
- 5 NUT sends BYE
- 6 NUT receives 200 OK

==== Message example ====

1. INVITE P-CSCF -> NUT

```
INVITE sip:UEa1_public_1@node.under.test.com:1357 SIP/2.0
Via: SIP/2.0/UDP p.a1.under.test.com:10001;branch=z9hG4bK431e418c233,
SIP/2.0/UDP s.a1.under.test.com;branch=z9hG4bK431e418c4.2;received=3ffe:501:ffff:100::30,
SIP/2.0/UDP i.a1.under.test.com;branch=z9hG4bKnashds418c5a;received=3ffe:501:ffff:100::20,
SIP/2.0/UDP s.a2.under.test.com;branch=z9hG4bK721e418c657u;received=3ffe:501:ffff:200::30,
SIP/2.0/UDP p.a2.under.test.com;branch=z9hG4bKnaghc45ca8;received=3ffe:501:ffff:200::10,
SIP/2.0/UDP [3ffe:501:ffff:2000::1000]:22222;branch=z9hG4bKnashds45ba91
Record-Route: <sip:p.a1.under.test.com:10001;lr>,<sip:s.a1.under.test.com;lr>,
<sip:s.a2.under.test.com;lr>,<sip:p.a2.under.test.com;lr>
Max-Forwards: 65
From: <sip:UEa2_public_1@under.test.com>;tag=10fxced76sl
To: <sip:UEa1_public_1@under.test.com>
Call-ID: 3848276298220188511@under.test.com
CSeq: 1 INVITE
Contact: <sip:UEa2_public_1@nodea2.under.test.com:22222>
Supported:
Allow: INVITE,ACK,CANCEL,OPTIONS,BYE
Allow-Events: reg
Accept: application/sdp,application/3gpp-ims+xml
P-Caller-Party-ID: <sip:UEa1_public_1@under.test.com>
Content-Type: application/sdp
Content-Length: 172
```



v=0
o=UEa2 2890844526 2890844526 IN IP6 nodea2.under.test.com
s=-
c=IN IP6 nodea2.under.test.com
t=0 0
m=audio 49172 RTP/AVP 0 18 96
b=AS:75
a=rtpmap:0 PCMU/8000
a=rtpmap:18 G729/8000
a=rtpmap:96 EVRC/8000

2. 180 Ringing NUT -> P-CSCF

SIP/2.0 180 Ringing

Via: SIP/2.0/UDP p.a1.under.test.com:10001;branch=z9hG4bK431e418c233;
received=3ffe:501:ffff:100::10,SIP/2.0/UDP s.a1.under.test.com;branch=z9hG4bK431e418c4.2;
received=3ffe:501:ffff:100::30,SIP/2.0/UDP i.a1.under.test.com;branch=z9hG4bKnashds418c5a;
received=3ffe:501:ffff:100::20,SIP/2.0/UDP s.a2.under.test.com;branch=z9hG4bK721e418c657u;
received=3ffe:501:ffff:200::30,SIP/2.0/UDP p.a2.under.test.com;branch=z9hG4bKnaghc45ca8;
received=3ffe:501:ffff:200::10,SIP/2.0/UDP [3ffe:501:ffff:2000::1000]:22222;branch=z9hG4bKnashds45ba91
From: <sip:UEa2_public_1@under.test.com>;tag=10fxced76sl
To: <sip:UEa1_public_1@under.test.com>;tag=414259
Call-ID: 3848276298220188511@under.test.com
CSeq: 1 INVITE
Content-Length: 0

3. 200 OK NUT -> P-CSCF

SIP/2.0 200 OK

Via: SIP/2.0/UDP p.a1.under.test.com:10001;branch=z9hG4bK431e418c233;
received=3ffe:501:ffff:100::10,SIP/2.0/UDP s.a1.under.test.com;branch=z9hG4bK431e418c4.2;
received=3ffe:501:ffff:100::30,SIP/2.0/UDP i.a1.under.test.com;branch=z9hG4bKnashds418c5a;
received=3ffe:501:ffff:100::20,SIP/2.0/UDP s.a2.under.test.com;branch=z9hG4bK721e418c657u;
received=3ffe:501:ffff:200::30,SIP/2.0/UDP p.a2.under.test.com;branch=z9hG4bKnaghc45ca8;
received=3ffe:501:ffff:200::10,SIP/2.0/UDP [3ffe:501:ffff:2000::1000]:22222;branch=z9hG4bKnashds45ba91
Record-Route: <sip:p.a1.under.test.com:10001;lr>,<sip:s.a1.under.test.com;lr>,
<sip:s.a2.under.test.com;lr>,<sip:p.a2.under.test.com;lr>
From: <sip:UEa2_public_1@under.test.com>;tag=10fxced76sl
To: <sip:UEa1_public_1@under.test.com>;tag=414259
Call-ID: 3848276298220188511@under.test.com
CSeq: 1 INVITE
Contact: <sip:UEa1_public_1@node.under.test.com:1357>
Supported:



Allow: INVITE,ACK,CANCEL,OPTIONS,BYE

Allow-Events: reg

Content-Type: application/sdp

Content-Length: 153

v=0

o=UEa1 2890844527 2890844527 IN IP6 node.under.test.com

s=-

c=IN IP6 node.under.test.com

t=0 0

m=audio 3456 RTP/AVP 0

b=AS:75

a=rtpmap:0 PCMU/8000

4. ACK P-CSCF -> NUT

ACK sip:UEa1_public_1@node.under.test.com:1357 SIP/2.0

Via: SIP/2.0/UDP p.a1.under.test.com:10001;branch=z9hG4bK431e418c234,

SIP/2.0/UDP s.a1.under.test.com;branch=z9hG4bK431e418c4.3;received=3ffe:501:ffff:100::30,

SIP/2.0/UDP s.a2.under.test.com;branch=z9hG4bK721e418c657v;received=3ffe:501:ffff:200::30,

SIP/2.0/UDP p.a2.under.test.com;branch=z9hG4bKnaghc45ca9;received=3ffe:501:ffff:200::10,

SIP/2.0/UDP [3ffe:501:ffff:2000::1000]:22222;branch=z9hG4bKnashds45ba92

Max-Forwards: 66

From: <sip:UEa2_public_1@under.test.com>;tag=10fxced76sl

To: <sip:UEa1_public_1@under.test.com>;tag=414259

Call-ID: 3848276298220188511@under.test.com

CSeq: 1 ACK

Content-Length: 0

As regards the message 5-6, please refer to the message 5-6 in UE-SE-B-4-AKA.

[OBSERVABLE RESULTS]

*1: 3 INVITE 200 OK from NUT to P-CSCF.

See generic_200-INVITE

- Message Body:

By the terminating UE, one codec per payload SHALL be selected exactly and only the selected codec for the related media stream SHALL be indicated upon sending a SDP answer to an SDP offer.[TS24229-6.1-43]



4.3.2 UE-SD-B-2-AKA - SDP offer which included an IP address type that is not supported (Receives INVITE and sends BYE)

[NAME]

UE-SD-B-2-AKA - SDP offer which included an IP address type that is not supported
(Receives INVITE and sends BYE)

[TARGET]

IMS User Equipment (NUT)

[PURPOSE]

To verify that the UEa1 properly process an INVITE with a SDP offer which included an IP address type that is not supported by the UEa1, and responds with a 488 (Not Acceptable Here) response with 301 Warning header indicating "incompatible network address format".

[REFERENCE]

TS24.229 6.1.3
RFC3261 13.3.1.3

[REQUIREMENT]

NONE

[PARAMETER(NUT)]

public-user-id : sip:UEa1_public_1@under.test.com
private-user-id : UEa1_private@under.test.com
contact_URI : sip:UEa1_public_1@node.under.test.com
HOMENETWORK Domain : sip:under.test.com

[PARAMETER(TESTER)]

public-user-id(UEa2) : sip:UEa2_public_1@under.test.com
P-CSCFa1 : sip:p.a1.under.test.com

[ADDRESS]



UEa1(NUT)	:	3ffe:501:fff:1000::1000
Router(R1)	:	3ffe:501:fff:1000::1
P-CSCFa1	:	3ffe:501:fff:100::10
I-CSCFa1	:	3ffe:501:fff:100::20
S-CSCFa1	:	3ffe:501:fff:100::30
DNS	:	3ffe:501:fff:100::40
DHCP	:	3ffe:501:fff:100::50
UEa2	:	3ffe:501:fff:2000::1000
P-CSCFa2	:	3ffe:501:fff:200::10
I-CSCFa2	:	3ffe:501:fff:200::20
S-CSCFa2	:	3ffe:501:fff:200::30

[TOPOLOGY]

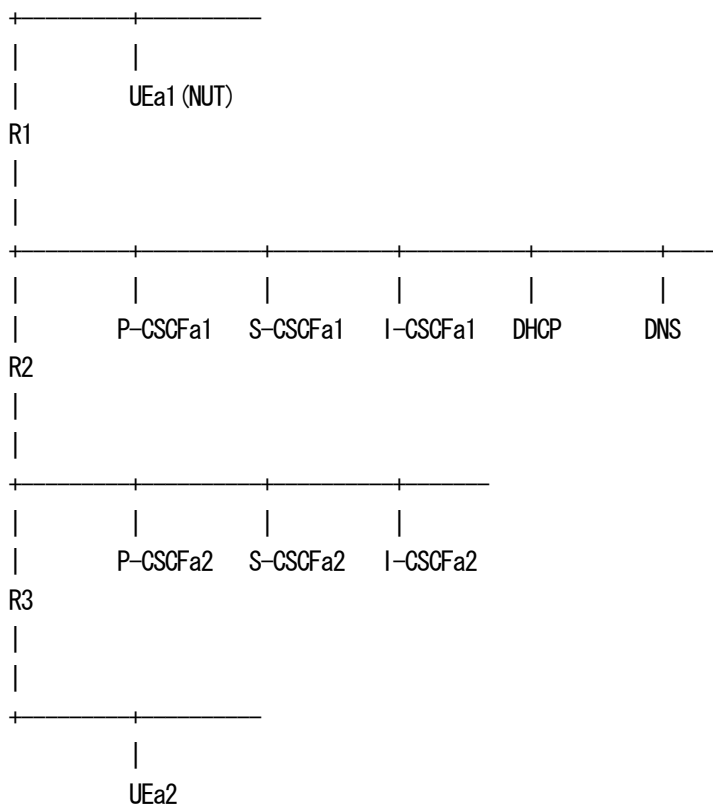

[INITIALIZATION]

UEa1(NUT) must be registered with the tester by executing the scenario "UE-INI-B-1-AKA".
For details of "UE-INI-B-1-AKA", refer to the profile "UE-RG-B-1-AKA".



[PROCEDURE]

Home Network

(NUT)

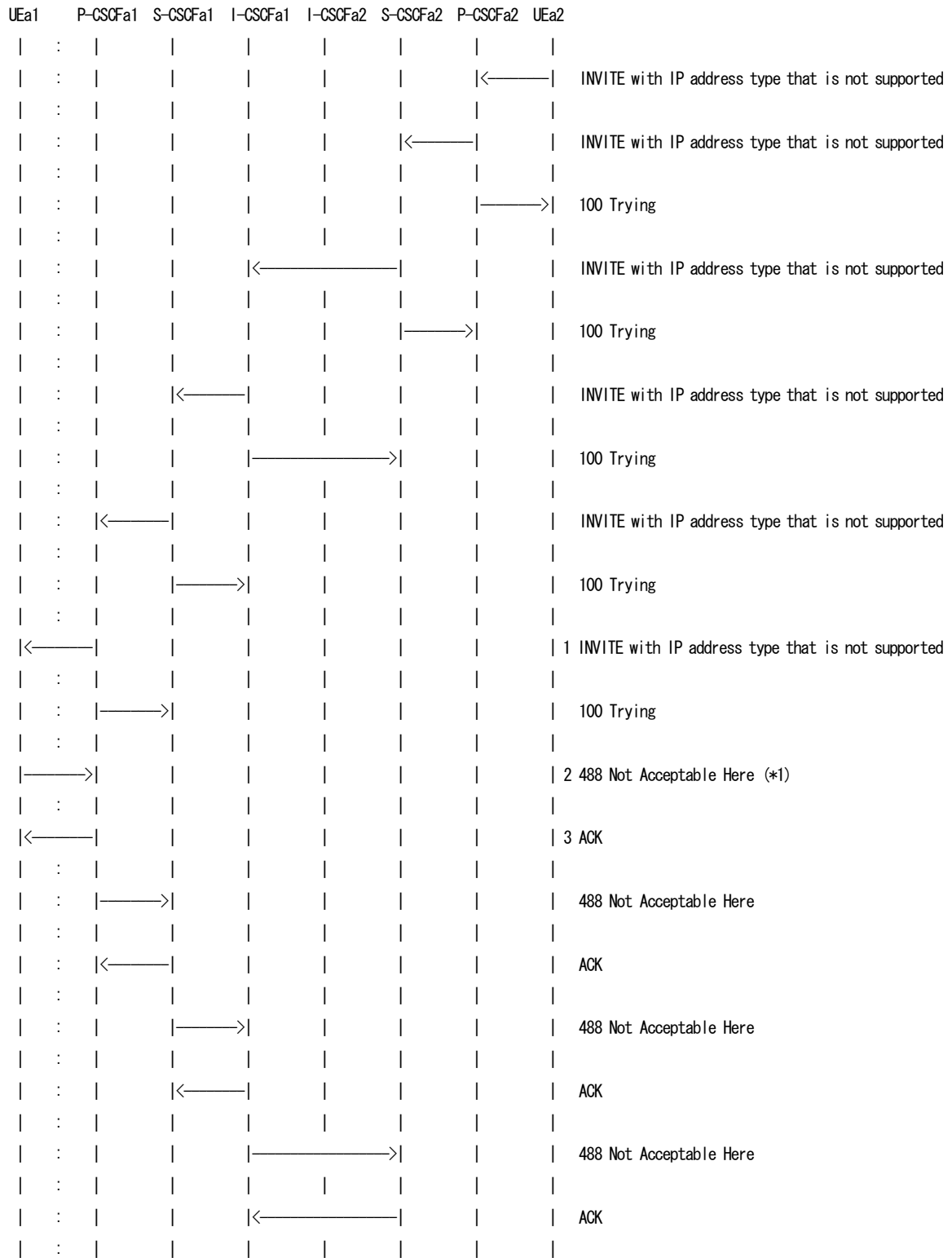

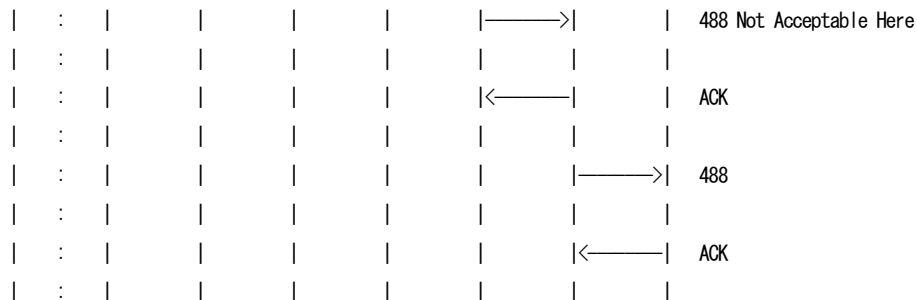

- 1 NUT receives INVITE
- 2 NUT sends 488 Not Acceptable Here
- 3 NUT receives ACK

=== Message example ===

1. INVITE P-CSCF -> NUT

```

INVITE sip:UEa1_public_1@node.under.test.com:1357 SIP/2.0
Via: SIP/2.0/UDP p.a1.under.test.com:10001;branch=z9hG4bK431e418c233,
SIP/2.0/UDP s.a1.under.test.com;branch=z9hG4bK431e418c4.2;received=3ffe:501:ffff:100::30,
SIP/2.0/UDP i.a1.under.test.com;branch=z9hG4bKnashds418c5a;received=3ffe:501:ffff:100::20,
SIP/2.0/UDP s.a2.under.test.com;branch=z9hG4bK721e418c657u;received=3ffe:501:ffff:200::30,
SIP/2.0/UDP p.a2.under.test.com;branch=z9hG4bKnaghc45ca8;received=3ffe:501:ffff:200::10,
SIP/2.0/UDP [3ffe:501:ffff:2000::1000]:22222;branch=z9hG4bKnashds45ba91
Record-Route: <sip:p.a1.under.test.com:10001;lr>,<sip:s.a1.under.test.com;lr>,
<sip:s.a2.under.test.com;lr>,<sip:p.a2.under.test.com;lr>
Max-Forwards: 65
From: <sip:UEa2_public_1@under.test.com>;tag=10fxced76sl
To: <sip:UEa1_public_1@under.test.com>
Call-ID: 3848276298220188511@under.test.com
CSeq: 1 INVITE
Contact: <sip:UEa2_public_1@nodea2.under.test.com:22222>
Supported:
Allow: INVITE,ACK,CANCEL,OPTIONS,BYE
Allow-Events: reg
Accept: application/sdp,application/3gpp-ims+xml
P-Called-Party-ID: <sip:UEa1_public_1@under.test.com>
Content-Type: application/sdp
Content-Length: 154

```

```

v=0
o=UEa2 2890844526 2890844526 IN IP6 nodea2.under.test.com
s=-

```



c=IN FOO nodea2.under.test.com
t=0 0
m=audio 49172 RTP/AVP 0
b=AS:75
a=rtpmap:0 PCMU/8000

2. 488 Not Acceptable Here NUT -> P-CSCF

SIP/2.0 488 Not Acceptable Here

Via: SIP/2.0/UDP p.a1.under.test.com:10001;branch=z9hG4bK431e418c233;
received=3ffe:501:ffff:100::10,SIP/2.0/UDP s.a1.under.test.com;branch=z9hG4bK431e418c4.2;
received=3ffe:501:ffff:100::30,SIP/2.0/UDP i.a1.under.test.com;branch=z9hG4bKnashds418c5a;
received=3ffe:501:ffff:100::20,SIP/2.0/UDP s.a2.under.test.com;branch=z9hG4bK721e418c657u;
received=3ffe:501:ffff:200::30,SIP/2.0/UDP p.a2.under.test.com;branch=z9hG4bKnaghc45ca8;
received=3ffe:501:ffff:200::10,SIP/2.0/UDP [3ffe:501:ffff:2000::1000]:22222;branch=z9hG4bKnashds45ba91
From: <sip:UEa2_public_1@under.test.com>;tag=10fxced76sl
To: <sip:UEa1_public_1@under.test.com>;tag=414259
Call-ID: 3848276298220188511@under.test.com
CSeq: 1 INVITE
Warning: 301 UEa1_public_1 "incompatible network address format"
Content-Length: 0

3. ACK P-CSCF -> NUT

ACK sip:UEa1_public_1@node.under.test.com:1357 SIP/2.0
Via: SIP/2.0/UDP p.a1.under.test.com:10001;branch=z9hG4bK431e418c233
Max-Forwards: 70
From: <sip:UEa2_public_1@under.test.com>;tag=10fxced76sl
To: <sip:UEa1_public_1@under.test.com>;tag=414259
Call-ID: 3848276298220188511@under.test.com
CSeq: 1 ACK
Content-Length: 0

[OBSERVABLE RESULTS]

*1: 2 488 Not Acceptable Here from NUT to P-CSCF.

See generic_3XX-6XX

- Exception{

* To

If a request contained a To tag in the request, the To header field



in the response MUST equal that of the request.[RFC3261-8.2-41]

The same tag MUST be used for all responses to that request, both final and provisional. [RFC3261-8.2-44]

}

- Header Field:

* Warning

Upon receiving an initial INVITE request, that includes the SDP offer containing an IP address type that is not supported by the UE, it SHALL respond with the 488 response with 301 Warning header indicating "incompatible network address format".[TS24229-6.1-47]

488 response SHOULD include a Warning header field value explaining why the offer was rejected.[RFC3261-13.3-9]

4.4 OPTIONS

4.4.1 UE-OP-B-1-AKA - OPTIONS request (Sends OPTIONS)

[NAME]

UE-OP-B-1-AKA - OPTIONS request (Sends OPTIONS)

[TARGET]

IMS User Equipment (NUT)

[PURPOSE]

To verify that the UEa1 properly sends OPTIONS request.

[REFERENCE]

TS24.229 A.2.1.3

RFC3261 11

RFC3261 11.1

[REQUIREMENT]

NONE



[PARAMETER(NUT)]

public-user-id : sip:UEa1_public_1@under.test.com
private-user-id : UEa1_private@under.test.com
contact_URI : sip:UEa1_public_1@node.under.test.com
HOMENETWORK Domain : sip:under.test.com

[PARAMETER(TESTER)]

public-user-id(UEa2) : sip:UEa2_public_1@under.test.com
P-CSCFa1 : sip:p.a1.under.test.com

[ADDRESS]

UEa1(NUT) : 3ffe:501:ffff:1000::1000
Router(R1) : 3ffe:501:ffff:1000::1
P-CSCFa1 : 3ffe:501:fff:100::10
I-CSCFa1 : 3ffe:501:fff:100::20
S-CSCFa1 : 3ffe:501:fff:100::30
DNS : 3ffe:501:fff:100::40
DHCP : 3ffe:501:fff:100::50

UEa2 : 3ffe:501:fff:2000::1000
P-CSCFa2 : 3ffe:501:fff:200::10
I-CSCFa2 : 3ffe:501:fff:200::20
S-CSCFa2 : 3ffe:501:fff:200::30

[TOPOLOGY]

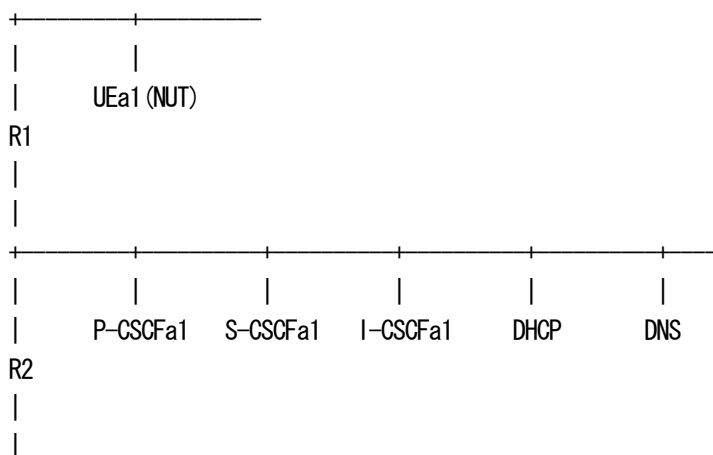

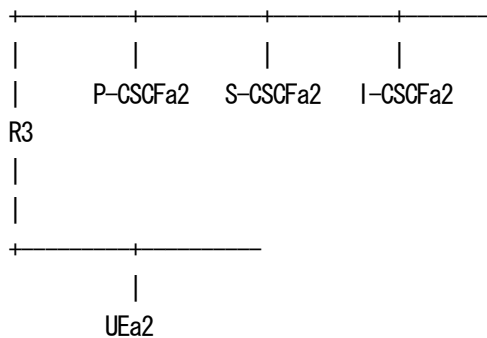

[INITIALIZATION]

UEa1(NUT) must be registered with the tester by executing the scenario "UE-INI-B-1-AKA".

For details of "UE-INI-B-1-AKA", refer to the profile "UE-RG-B-1-AKA".

[PROCEDURE]

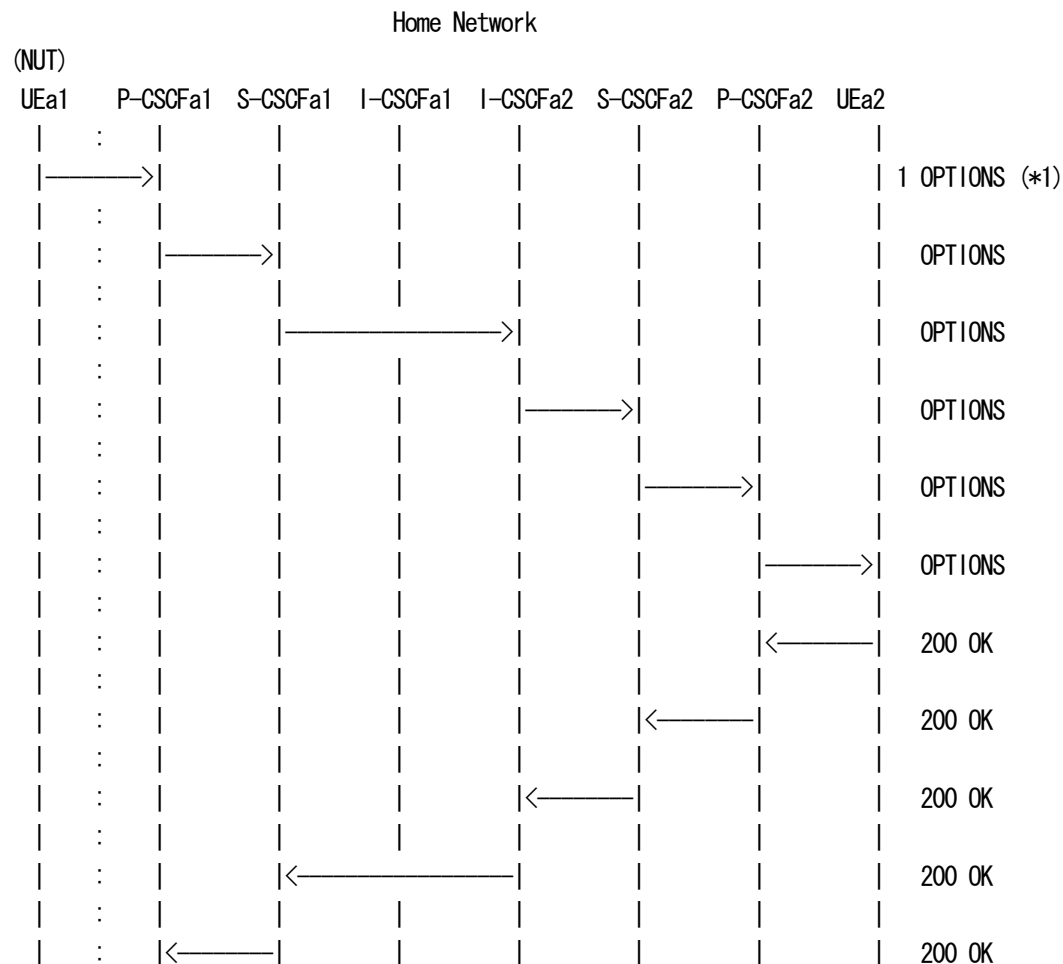



1 NUT sends OPTIONS

2 NUT receives 200 OK

=== Message example ===

1. OPTIONS NUT -> P-CSCF

OPTIONS sip:UEa2_public_1@under.test.com SIP/2.0

Via: SIP/2.0/UDP [3ffe:501:ffff:1000::1000]:1357;branch=z9hG4bK74b1a

Route: <sip:p.a1.under.test.com:10001;lr>,<sip:orig@s.a1.under.test.com;lr>

Max-Forwards: 70

Proxy-Require: sec-agree

Require: sec-agree

From: <sip:UEa1_public_1@under.test.com>;tag=9fxced76tm

To: <sip:UEa2_public_1@under.test.com>

Call-ID: 3848276298220188522@under.test.com

CSeq: 1 OPTIONS

Security-Verify: ipsec-3gpp; alg=hmac-sha-1-96; spi-c=256; spi-s=257; port-c=10002; port-s=10001

Accept: application/sdp,application/3gpp-ims+xml

Content-Length: 0

2. 200 OK P-CSCF -> NUT

SIP/2.0 200 OK

Via: SIP/2.0/UDP [3ffe:501:ffff:1000::1000]:1357;branch=z9hG4bK74b1a

From: <sip:UEa1_public_1@under.test.com>;tag=9fxced76tm

To: <sip:UEa2_public_1@under.test.com>;tag=314160

Call-ID: 3848276298220188522@under.test.com

CSeq: 1 OPTIONS

Supported: path

Allow: INVITE,ACK,CANCEL,OPTIONS,BYE

Accept: application/sdp,application/3gpp-ims+xml

Accept-Encoding: identity

Accept-Language: en

Allow-Events: reg

Content-Type: application/sdp

Content-Length: 147

v=0

o=UEa2 2890844526 2890844526 IN IP6 nodea2.under.test.com



S=-
c=IN IP6 nodea2.under.test.com
t=0 0
m=audio 49172 RTP/AVP 0
b=AS:75
a=rtpmap:0 PCMU/8000

[OBSERVABLE RESULTS]

*1: 1 OPTIONS request from NUT to P-CSCF.

See generic_OPTIONS

4.4.2 UE-OP-B-2-AKA - OPTIONS request (Receives OPTIONS)

[NAME]
UE-OP-B-2-AKA - OPTIONS request (Receives OPTINOS)

[TARGET]
IMS User Equipment (NUT)

[PURPOSE]
To verify that the UEa1 properly sends 200 response to OPTIONS.

[REFERENCE]
TS24.229 A.2.1.3
RFC3261 11
RFC3261 11.2

[REQUIREMENT]
NONE

[PARAMETER(NUT)]
public-user-id : sip:UEa1_public_1@under.test.com
private-user-id : UEa1_private@under.test.com
contact_URI : sip:UEa1_public_1@node.under.test.com



HOMENETWORK Domain : sip:under.test.com

[PARAMETER(TESTER)]

public-user-id(UEa2) : sip:UEa2_public_1@under.test.com
P-CSCFa1 : sip:p.a1.under.test.com

[ADDRESS]

UEa1(NUT) : 3ffe:501:fff:1000::1000
Router(R1) : 3ffe:501:fff:1000::1
P-CSCFa1 : 3ffe:501:fff:100::10
I-CSCFa1 : 3ffe:501:fff:100::20
S-CSCFa1 : 3ffe:501:fff:100::30
DNS : 3ffe:501:fff:100::40
DHCP : 3ffe:501:fff:100::50

UEa2 : 3ffe:501:fff:2000::1000
P-CSCFa2 : 3ffe:501:fff:200::10
I-CSCFa2 : 3ffe:501:fff:200::20
S-CSCFa2 : 3ffe:501:fff:200::30

[TOPOLOGY]

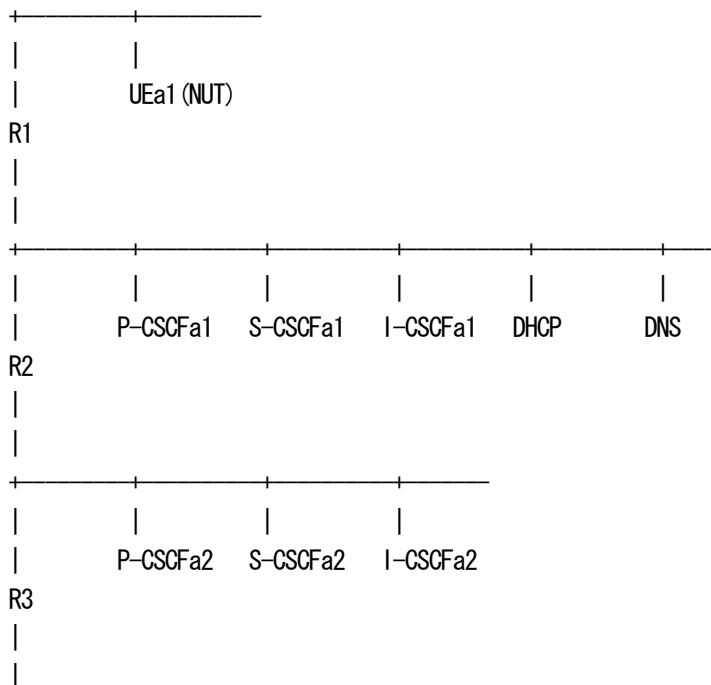

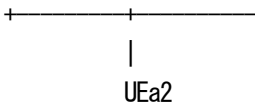

[INITIALIZATION]

UEa1(NUT) must be registered with the tester by executing the scenario "UE-INI-B-1-AKA".
 For details of "UE-INI-B-1-AKA", refer to the profile "UE-RG-B-1-AKA".

[PROCEDURE]

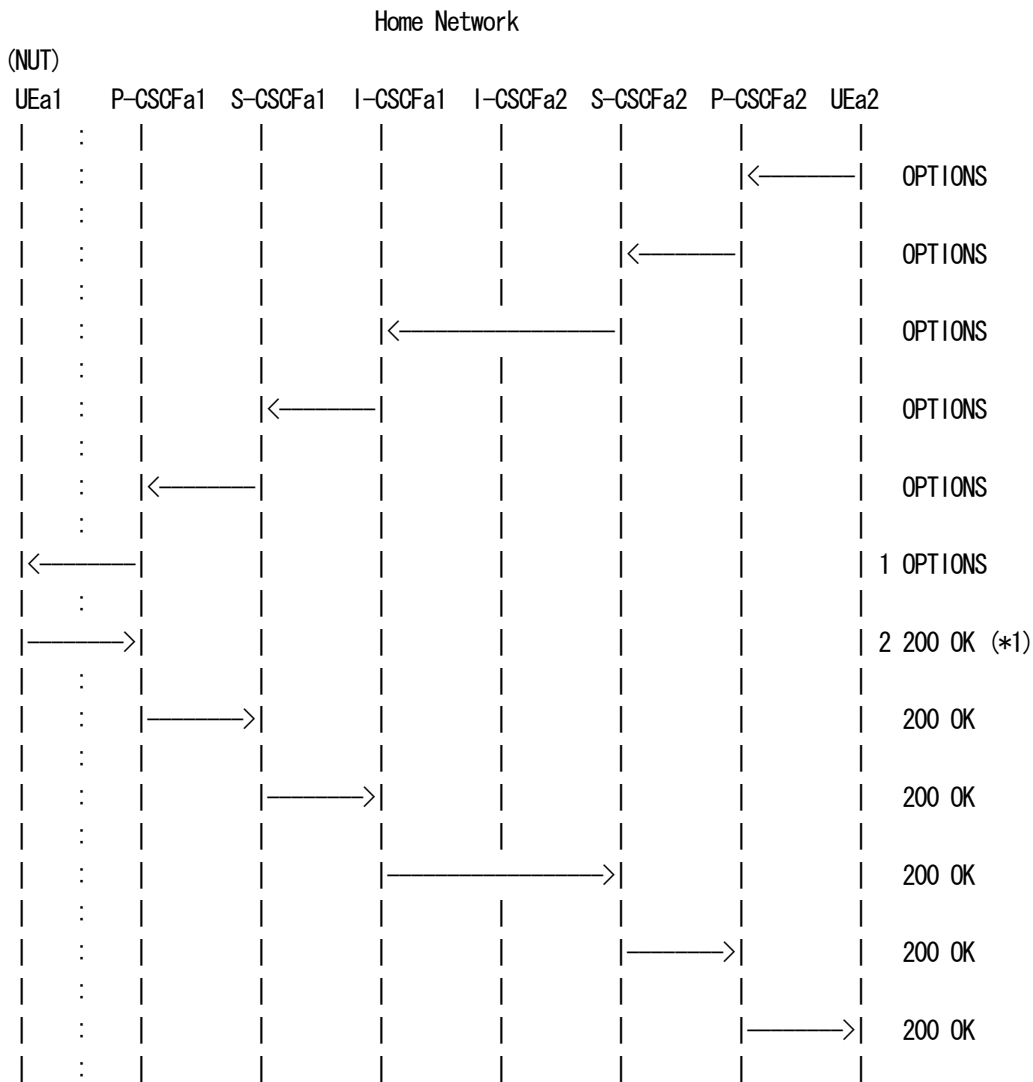

1 NUT receives OPTIONS
 2 NUT sends 200 OK



==== Message example ====

1. OPTIONS P-CSCF -> NUT

OPTIONS sip:UEa1_public_1@under.test.com:1357 SIP/2.0
Via: SIP/2.0/UDP p.a1.under.test.com:10001;branch=z9hG4bK431h23.1,
SIP/2.0/UDP s.a1.under.test.com;branch=z9hG4bK332b23.1;received=3ffe:501:ffff:100::30,
SIP/2.0/UDP i.a1.under.test.com;branch=z9hG4bK871y12.1;received=3ffe:501:ffff:100::20,
SIP/2.0/UDP s.a2.under.test.com;branch=z9hG4bK764z87.1;received=3ffe:501:ffff:200::30,
SIP/2.0/UDP p.a2.under.test.com;branch=z9hG4bK361k21.1;received=3ffe:501:ffff:200::10,
SIP/2.0/UDP [3ffe:501:ffff:2000::1000]:22222;branch=z9hG4bK834y72.2
Max-Forwards: 65
From: <sip:UEa2_public_1@under.test.com>;tag=314160
To: <sip:UEa1_public_1@under.test.com>
Call-ID: 3848276298220188533@under.test.com
CSeq: 1 OPTIONS
Accept: application/sdp,application/3gpp-ims+xml
P-Called-Party-ID: <sip:UEa1_public_1@under.test.com>
Content-Length: 0

2. 200 OK NUT -> P-CSCF

SIP/2.0 200 OK
Via: SIP/2.0/UDP p.a1.under.test.com:10001;branch=z9hG4bK431h23.1;r
eceived=3ffe:501:ffff:100::10,SIP/2.0/UDP s.a1.under.test.com;branch=z9hG4bK332b23.1;
received=3ffe:501:ffff:100::30,SIP/2.0/UDP i.a1.under.test.com;branch=z9hG4bK871y12.1;
received=3ffe:501:ffff:100::20,SIP/2.0/UDP s.a2.under.test.com;branch=z9hG4bK764z87.1;
received=3ffe:501:ffff:200::30,SIP/2.0/UDP p.a2.under.test.com;branch=z9hG4bK361k21.1;
received=3ffe:501:ffff:200::10,SIP/2.0/UDP [3ffe:501:ffff:2000::1000]:22222;branch=z9hG4bK834y72.2
From: <sip:UEa2_public_1@under.test.com>;tag=314160
To: <sip:UEa1_public_1@under.test.com>;tag=9fxced76tm
Call-ID: 3848276298220188533@under.test.com
CSeq: 1 OPTIONS
Allow: INVITE,ACK,CANCEL,OPTIONS,BYE
Accept: application/sdp,application/3gpp-ims+xml
Accept-Encoding: gzip
Accept-Language: en
Allow-Events: reg
Supported: path
Content-Type: application/sdp
Content-Length: 147

v=0

o=UEa1 2890844526 2890844526 IN IP6 node.under.test.com



S=
c=IN IP6 node.under.test.com
t=0 0
m=audio 49172 RTP/AVP 0
b=AS:75
a=rtpmap:0 PCMU/8000

[OBSERVABLE RESULTS]

*1: 2 200 OK response from NUT to P-CSCF.

See generic_200-OPTIONS

4.5 SIP timer

4.5.1 UE-TM-B-1-AKA - Timer B expiration to INVITE

[NAME]
UE-TM-B-1-AKA - Timer B expiration to INVITE

[TARGET]
IMS User Equipment (NUT)

[PURPOSE]
To verify that the UEa1 stops retransmitting INVITE after time B expired.

[REFERENCE]
TS24.229 7.7
RFC3261 17.1.1.2

[REQUIREMENT]
NONE

[PARAMETER(NUT)]
public-user-id : sip:UEa1_public_1@under.test.com



private-user-id : UEa1_private@under.test.com
contact_URI : sip:UEa1_public_1@node.under.test.com
HOMENETWORK Domain : sip:under.test.com

[PARAMETER(TESTER)]

public-user-id(UEa2) : sip:UEa2_public_1@under.test.com
P-CSCFa1 : sip:p.a1.under.test.com

[ADDRESS]

UEa1(NUT) : 3ffe:501:ffff:1000::1000
Router(R1) : 3ffe:501:ffff:1000::1
P-CSCFa1 : 3ffe:501:ffff:100::10
I-CSCFa1 : 3ffe:501:ffff:100::20
S-CSCFa1 : 3ffe:501:ffff:100::30
DNS : 3ffe:501:ffff:100::40
DHCP : 3ffe:501:ffff:100::50

UEa2 : 3ffe:501:ffff:2000::1000
P-CSCFa2 : 3ffe:501:ffff:200::10
I-CSCFa2 : 3ffe:501:ffff:200::20
S-CSCFa2 : 3ffe:501:ffff:200::30

[TOPOLOGY]

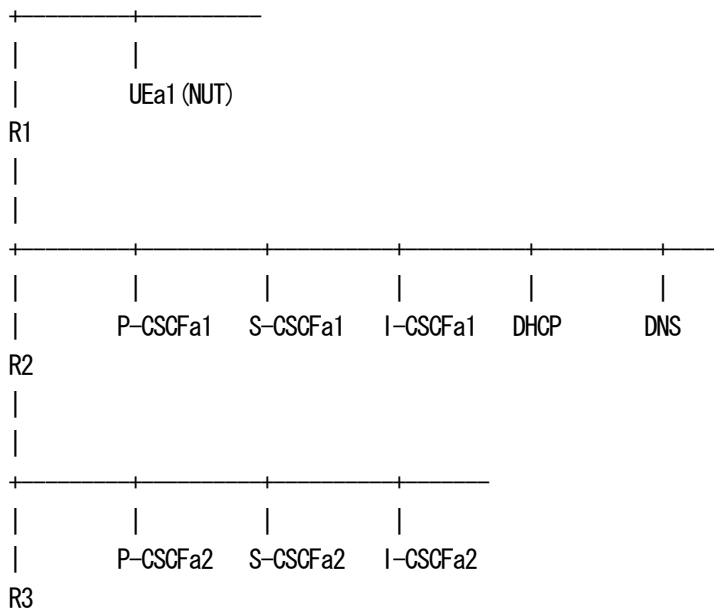

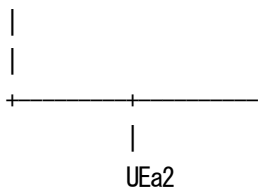

[INITIALIZATION]

UEa1(NUT) must be registered with the tester by executing the scenario "UE-INI-B-1-AKA".
 For details of "UE-INI-B-1-AKA", refer to the profile "UE-RG-B-1-AKA".

[PROCEDURE]

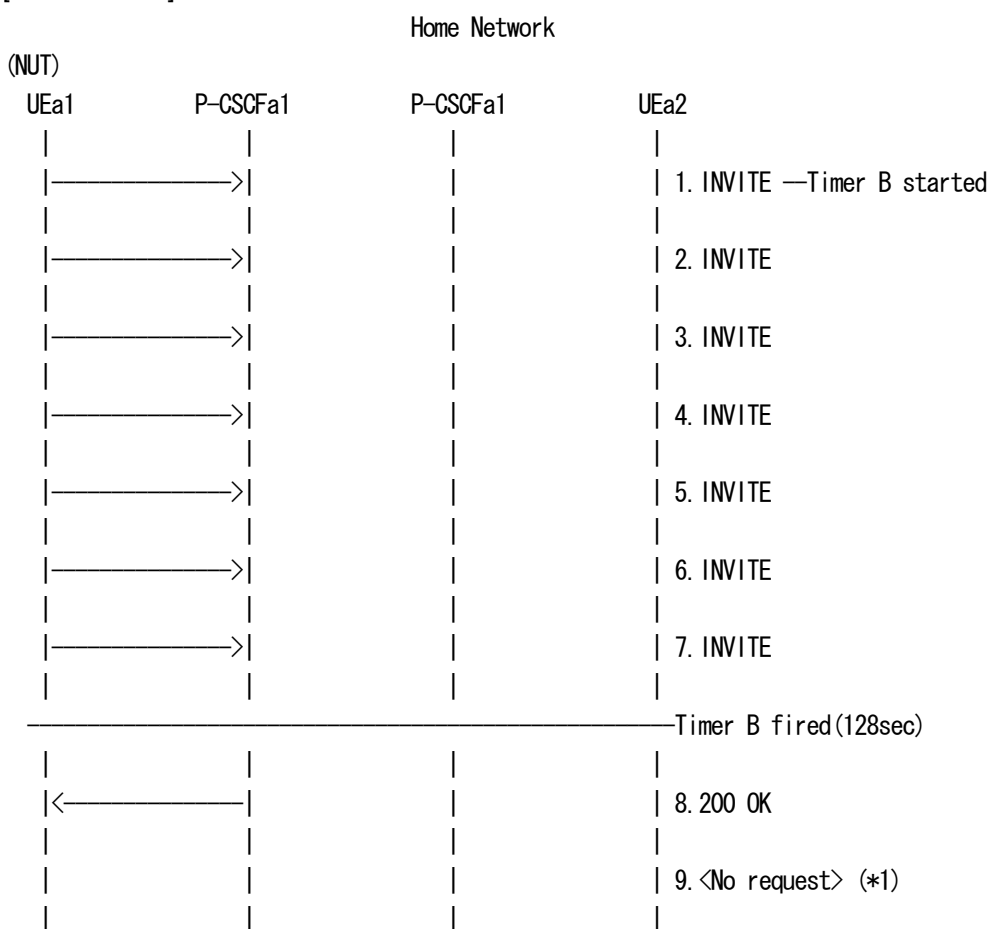

- 1-7. NUT sends INVITE
- 8. NUT receives 200 OK
- 9. <No request>



==== Message example ====

1-7. INVITE NUT -> P-CSCF

INVITE sip:UEa2_public_1@under.test.com SIP/2.0

Via: SIP/2.0/UDP [3ffe:501:ffff:1000::1000]:1357;branch=z9hG4bK74bf9

Route: <sip:p.a1.under.test.com:10001;lr>,<sip:orig@s.a1.under.test.com;lr>

Max-Forwards: 70

From: <sip:UEa1_public_1@under.test.com>;tag=9fxced76sl

To: <sip:UEa2_public_1@under.test.com>

Call-ID: 3848276298220188511@under.test.com

CSeq: 1 INVITE

Contact: <sip:UEa1_public_1@node.under.test.com:1357>

Supported:

Allow: INVITE,ACK,CANCEL,OPTIONS,BYE

Allow-Events: reg

Accept: application/sdp,application/3gpp-ims+xml

Require: sec-agree

Proxy-Require: sec-agree

Security-Verify: ipsec-3gpp; alg= hmac-sha-1-96; spi-c=256; spi-s=257; port-c=10002; port-s=10001

Content-Type: application/sdp

Content-Length: 154

v=0

o=UEa1 2890844526 2890844526 IN IP6 node.under.test.com

s=-

c=IN IP6 node.under.test.com

t=0 0

m=audio 49172 RTP/AVP 0

b=AS:75

a=rtpmap:0 PCMU/8000

8. 200 OK P-CSCF -> NUT

SIP/2.0 200 OK

Via: SIP/2.0/UDP [3ffe:501:ffff:1000::1000]:1357;branch=z9hG4bK74bf9

Record-Route: <sip:p.a2.under.test.com;lr>,<sip:s.a2.under.test.com;lr>,<sip:s.a1.under.test.com;lr>,<sip:p.a1.under.test.com:10001;lr>

From: <sip:UEa1_public_1@under.test.com>;tag=9fxced76sl

To: <sip:UEa2_public_1@under.test.com>;tag=314259

Call-ID: 3848276298220188511@under.test.com

CSeq: 1 INVITE

Contact: <sip:UEa2_public_1@nodea2.under.test.com:22222>

Supported:



Allow: INVITE,ACK,CANCEL,OPTIONS,BYE

Allow-Events: reg

Content-Type: application/sdp

Content-Length: 153

v=0

o=UEa2 2890844527 2890844527 IN IP6 nodea2.under.test.com

s=-

c=IN IP6 nodea2.under.test.com

t=0 0

m=audio 3456 RTP/AVP 0

b=AS:75

a=rtpmap:0 PCMU/8000

9. <No request>

[OBSERVABLE RESULTS]

*1: 9 No request

The client transaction MUST NOT generate an ACK.[RFC3261-17.1-16]

4.5.2 UE-TM-B-2-AKA - Timer D expiration

[NAME]

UE-TM-B-2-AKA - Timer D expiration

[TARGET]

IMS User Equipment (NUT)

[PURPOSE]

To verify that UEa1 properly sends ACK to 486(Busy Here) before timer D expired.

[REFERENCE]

TS24.229 7.7

RFC3261 17.1.1.2



[REQUIREMENT]

NONE

[PARAMETER(NUT)]

public-user-id : sip:UEa1_public_1@under.test.com
private-user-id : UEa1_private@under.test.com
contact_URI : sip:UEa1_public_1@node.under.test.com
HOMENETWORK Domain : sip:under.test.com

[PARAMETER(TESTER)]

public-user-id(UEa2) : sip:UEa2_public_1@under.test.com
P-CSCFa1 : sip:p.a1.under.test.com

[ADDRESS]

UEa1(NUT) : 3ffe:501:ffff:1000::1000
Router(R1) : 3ffe:501:ffff:1000::1
P-CSCFa1 : 3ffe:501:ffff:100::10
I-CSCFa1 : 3ffe:501:ffff:100::20
S-CSCFa1 : 3ffe:501:ffff:100::30
DNS : 3ffe:501:ffff:100::40
DHCP : 3ffe:501:ffff:100::50

UEa2 : 3ffe:501:ffff:2000::1000
P-CSCFa2 : 3ffe:501:ffff:200::10
I-CSCFa2 : 3ffe:501:ffff:200::20
S-CSCFa2 : 3ffe:501:ffff:200::30

[TOPOLOGY]

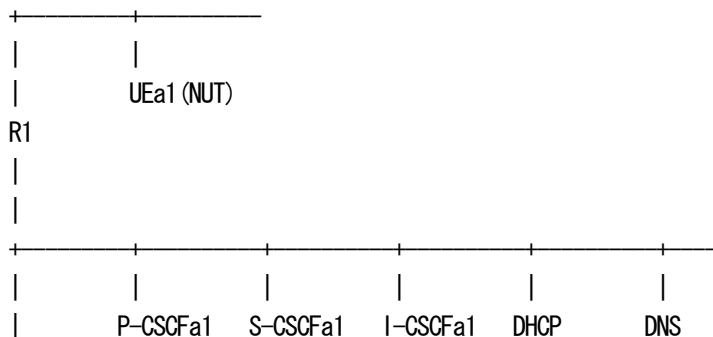

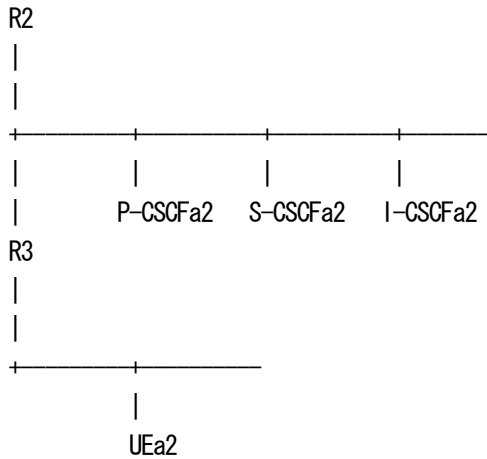

[INITIALIZATION]

UEa1(NUT) must be registered with the tester by executing the scenario "UE-INI-B-1-AKA".
 For details of "UE-INI-B-1-AKA", refer to the profile "UE-RG-B-1-AKA".

[PROCEDURE]

Home Network

(NUT)

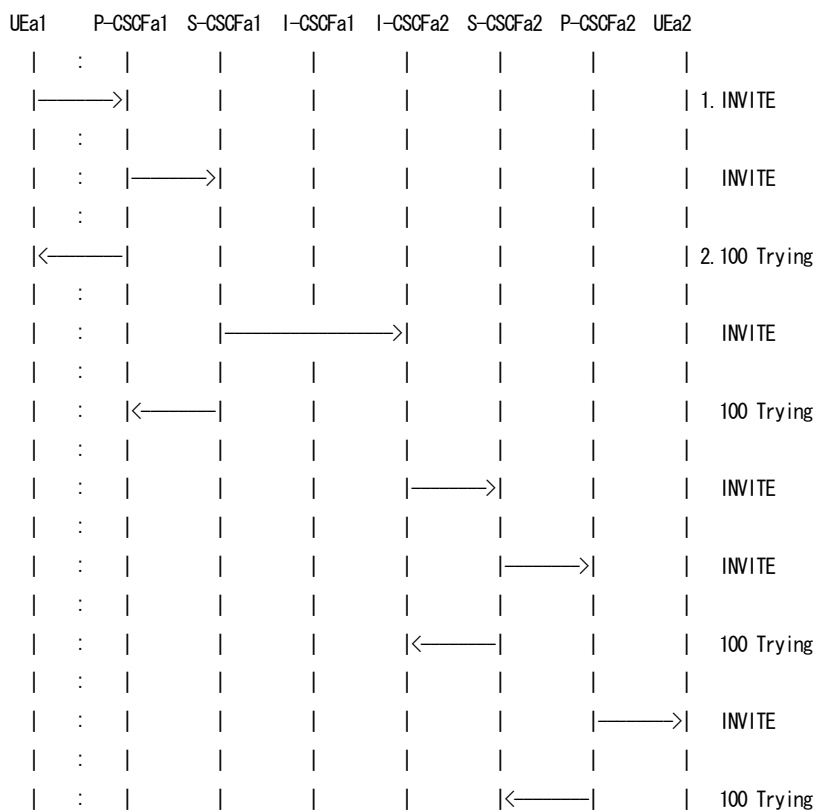

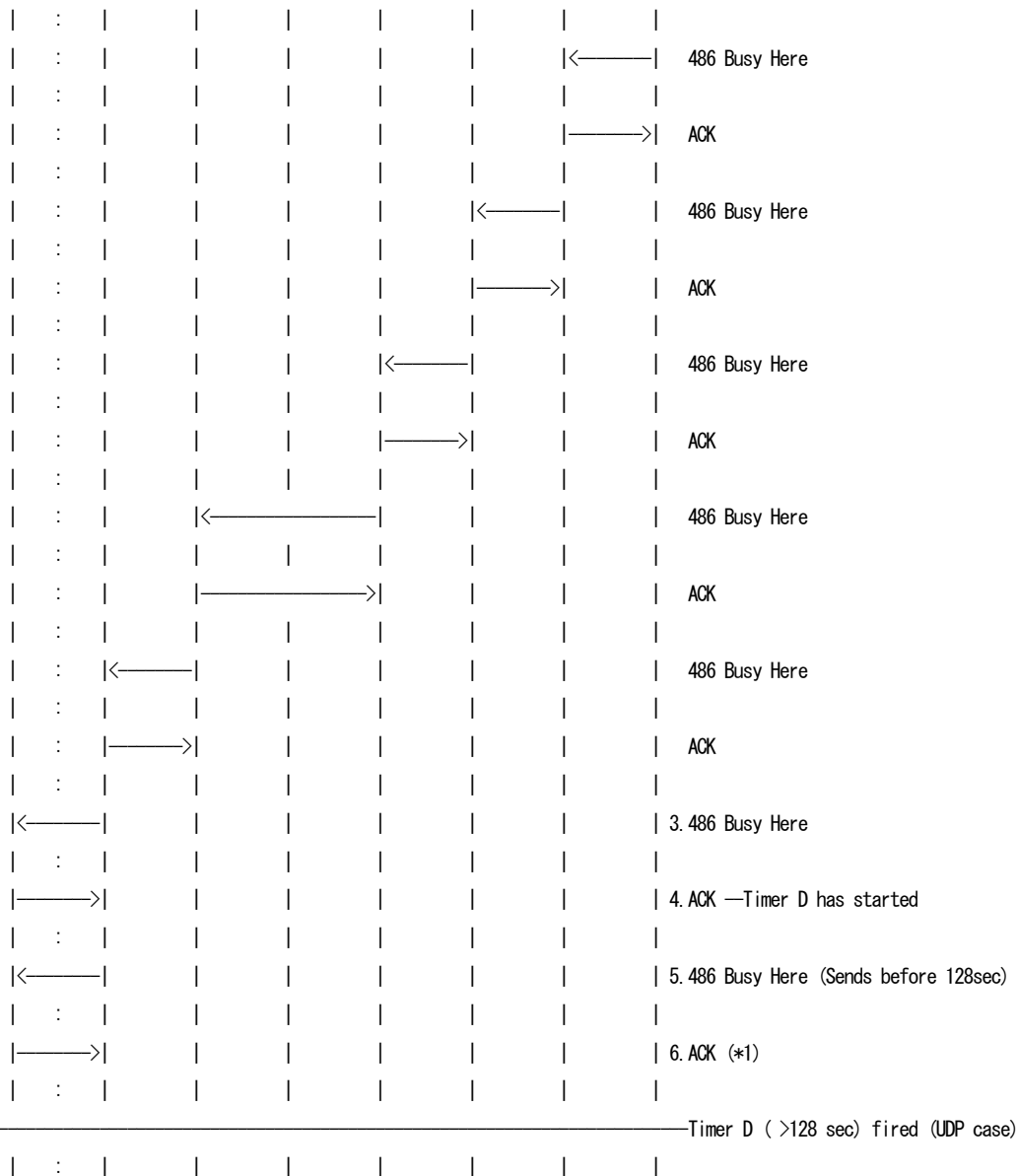

- 1 NUT sends INVITE
- 2 NUT receives 100 Trying
- 3 NUT receives 486 Busy Here
- 4 NUT sends ACK
- 5 NUT receives 486 Busy Here
- 6 NUT sends ACK

=== Message example ===

1. INVITE NUT -> P-CSCF



INVITE sip:UEa2_public_1@under.test.com SIP/2.0
Via: SIP/2.0/UDP [3ffe:501:ffff:1000::1000]:1357;branch=z9hG4bK74bf9
Route: <sip:p.a1.under.test.com:10001;lr>,<sip:orig@s.a1.under.test.com;lr>
Max-Forwards: 70
From: <sip:UEa1_public_1@under.test.com>;tag=9fxced76sl
To: <sip:UEa2_public_1@under.test.com>
Call-ID: 3848276298220188511@under.test.com
CSeq: 1 INVITE
Contact: <sip:UEa1_public_1@node.under.test.com:1357>
Supported:
Allow: INVITE,ACK,CANCEL,OPTIONS,BYE
Allow-Events: reg
Accept: application/sdp,application/3gpp-ims+xml
Require: sec-agree
Proxy-Require: sec-agree
Security-Verify: ipsec-3gpp; alg=hmac-sha-1-96; spi-c=256; spi-s=257; port-c=10002; port-s=10001
Content-Type: application/sdp
Content-Length: 154

v=0
o=UEa1 2890844526 2890844526 IN IP6 node.under.test.com
s=-
c=IN IP6 node.under.test.com
t=0 0
m=audio 49172 RTP/AVP 0
b=AS:75
a=rtpmap:0 PCMU/8000

2. 100 Trying P-CSCF -> NUT

SIP/2.0 100 Trying
Via: SIP/2.0/UDP [3ffe:501:ffff:1000::1000]:1357;branch=z9hG4bK74bf9
From: <sip:UEa1_public_1@under.test.com>;tag=9fxced76sl
To: <sip:UEa2_public_1@under.test.com>
Call-ID: 3848276298220188511@under.test.com
CSeq: 1 INVITE
Content-Length: 0

3. 486 Busy Here P-CSCF -> NUT

SIP/2.0 486 Busy Here
Via: SIP/2.0/UDP [3ffe:501:ffff:1000::1000]:1357;branch=z9hG4bK74bf9
Call-ID: 3848276298220188511@under.test.com



From: <sip:UEa1_public_1@under.test.com>;tag=9fxced76sl
To: <sip:UEa2_public_1@under.test.com>;tag=314259
CSeq: 1 INVITE
Content-Length: 0

4. ACK NUT -> P-CSCF

ACK sip:UEa2_public_1@under.test.com SIP/2.0
Via: SIP/2.0/UDP [3ffe:501:ffff:1000::1000]:1357;branch=z9hG4bK74bf9
Route: <sip:p.a1.under.test.com:10001;lr>,<sip:orig@s.a1.under.test.com;lr>
Max-Forwards: 70
From: <sip:UEa1_public_1@under.test.com>;tag=9fxced76sl
To: <sip:UEa2_public_1@under.test.com>;tag=314259
Call-ID: 3848276298220188511@under.test.com
CSeq: 1 ACK
Content-Length: 0

As regards the message 5-6, please refer to the message 3-4 in this.

[OBSERVABLE RESULTS]

*1: 6 ACK form NUT to P-CSCF.

See generic_ACK-non2XX

Any retransmissions of the final response that are received while in the "Completed" state MUST cause the ACK to be re-passed to the transport layer for retransmission.[RFC3261-17.1-25]

4.5.3 UE-TM-B-3-AKA - Timer H expiration

[NAME]

UE-TM-B-3-AKA - Timer H expiration

[TARGET]

IMS User Equipment (NUT)

[PURPOSE]



To verify that UEa1 stops resending 4XX-6XX after timer H expired .

[REFERENCE]

TS24.229 7.7
RFC3261 17.2.1

[REQUIREMENT]

NONE

[PARAMETER(NUT)]

public-user-id : sip:UEa1_public_1@under.test.com
private-user-id : UEa1_private@under.test.com
contact_URI : sip:UEa1_public_1@node.under.test.com
HOMENETWORK Domain : sip:under.test.com

[PARAMETER(TESTER)]

public-user-id(UEa2) : sip:UEa2_public_1@under.test.com
P-CSCFa1 : sip:p.a1.under.test.com

[ADDRESS]

UEa1(NUT) : 3ffe:501:ffff:1000::1000
Router(R1) : 3ffe:501:ffff:1000::1
P-CSCFa1 : 3ffe:501:ffff:100::10
I-CSCFa1 : 3ffe:501:ffff:100::20
S-CSCFa1 : 3ffe:501:ffff:100::30
DNS : 3ffe:501:ffff:100::40
DHCP : 3ffe:501:ffff:100::50

UEa2 : 3ffe:501:ffff:2000::1000
P-CSCFa2 : 3ffe:501:ffff:200::10
I-CSCFa2 : 3ffe:501:ffff:200::20
S-CSCFa2 : 3ffe:501:ffff:200::30

[TOPOLOGY]

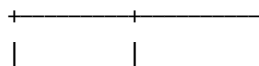

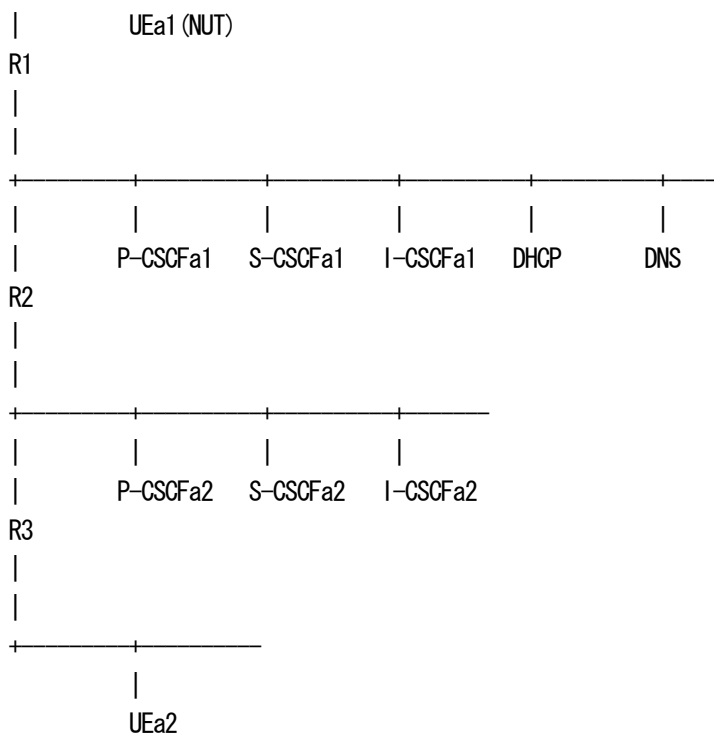

[INITIALIZATION]

UEa1(NUT) must be registered with the tester by executing the scenario "UE-INI-B-1-AKA".
 For details of "UE-INI-B-1-AKA", refer to the profile "UE-RG-B-1-AKA".

[PROCEDURE]

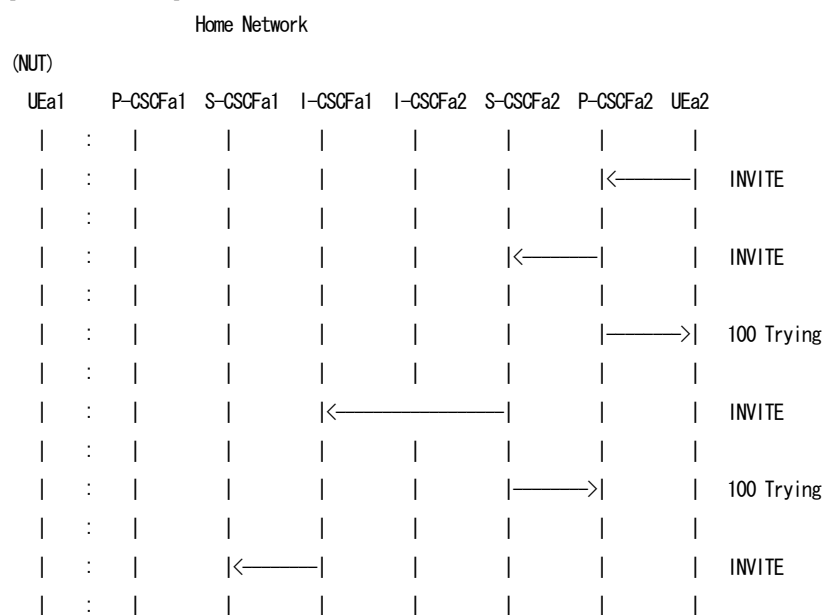



Contact: <sip:UEa2_public_1@nodea2.under.test.com:22222>

Supported:

Allow: INVITE,ACK,CANCEL,OPTIONS,BYE

Allow-Events: reg

Accept: application/sdp,application/3gpp-ims+xml

P-Called-Party-ID: <sip:UEa1_public_1@under.test.com>

Content-Type: application/sdp

Content-Length: 154

v=0

o=UEa2 2890844526 2890844526 IN FOO nodea2.under.test.com

s=-

c=IN FOO nodea2.under.test.com

t=0 0

m=audio 49172 RTP/AVP 0

b=AS:75

a=rtpmap:0 PMCU/20000

2-4. 4XX-6XX NUT -> P-CSCF

SIP/2.0 488 Not Acceptable Here

Via: SIP/2.0/UDP p.a1.under.test.com:10001;branch=z9hG4bK431e418c233;

received=3ffe:501:ffff:100::10,SIP/2.0/UDP s.a1.under.test.com;branch=z9hG4bK431e418c4.2;

received=3ffe:501:ffff:100::30,SIP/2.0/UDP i.a1.under.test.com;branch=z9hG4bKnashds418c5a;

received=3ffe:501:ffff:100::20,SIP/2.0/UDP s.a2.under.test.com;branch=z9hG4bK721e418c657u;

received=3ffe:501:ffff:200::30,SIP/2.0/UDP p.a2.under.test.com;branch=z9hG4bKnaghc45ca8;

received=3ffe:501:ffff:200::10,SIP/2.0/UDP [3ffe:501:ffff:2000::1000]:22222;branch=z9hG4bKnashds45ba91

From: <sip:UEa2_public_1@under.test.com>;tag=10fxcdd76sl

To: <sip:UEa1_public_1@under.test.com>;tag=414259

Call-ID: 3848276298220188511@under.test.com

CSeq: 1 INVITE

Warning: 301 UEa1_public_1 "incompatible network address format"

Content-Length: 0

5. <No retry>

[OBSERVABLE RESULTS]

*1: 5 No Retry



4.5.4 UE-TM-B-4-AKA - Timer J expiration

[NAME]

UE-TM-B-4-AKA - Timer J expiration

[TARGET]

IMS User Equipment (NUT)

[PURPOSE]

To verify that the UEa1 properly sends 481(Transaction Does Not Exist) to CANCEL after time J expired .

[REFERENCE]

TS24.229 7.7

RFC3261 17.2.2

[REQUIREMENT]

NONE

[PARAMETER(NUT)]

public-user-id : sip:UEa1_public_1@under.test.com
private-user-id : UEa1_private@under.test.com
contact_URI : sip:UEa1_public_1@node.under.test.com
HOMENETWORK Domain : sip:under.test.com

[PARAMETER(TESTER)]

public-user-id(UEa2) : sip:UEa2_public_1@under.test.com
P-CSCFa1 : sip:p.a1.under.test.com

[ADDRESS]

UEa1(NUT) : 3ffe:501:ffff:1000::1000
Router(R1) : 3ffe:501:ffff:1000::1
P-CSCFa1 : 3ffe:501:ffff:100::10
I-CSCFa1 : 3ffe:501:ffff:100::20
S-CSCFa1 : 3ffe:501:ffff:100::30
DNS : 3ffe:501:ffff:100::40



DHCP : 3ffe:501:fff:100::50

UEa2 : 3ffe:501:fff:2000::1000

P-CSCFa2 : 3ffe:501:fff:200::10

I-CSCFa2 : 3ffe:501:fff:200::20

S-CSCFa2 : 3ffe:501:fff:200::30

[TOPOLOGY]

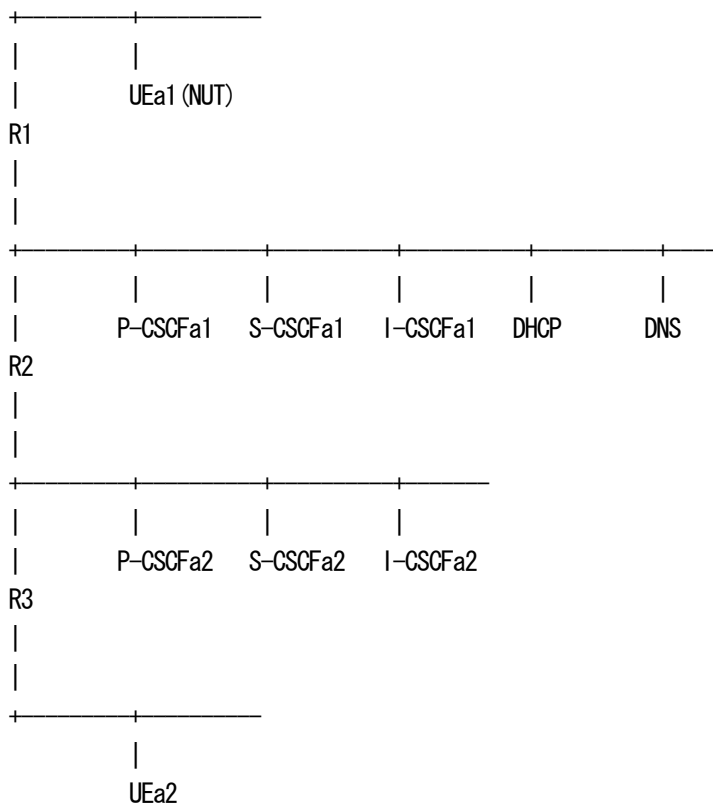

[INITIALIZATION]

UEa1(NUT) must be registered with the tester by executing the scenario "UE-INI-B-1-AKA".
 For details of "UE-INI-B-1-AKA", refer to the profile "UE-RG-B-1-AKA".

[PROCEDURE]

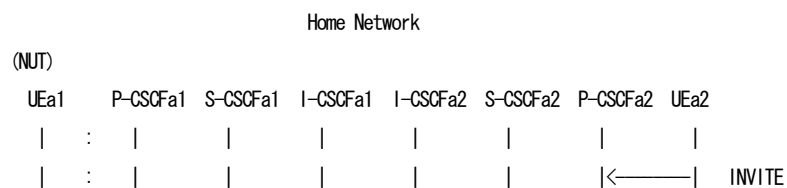

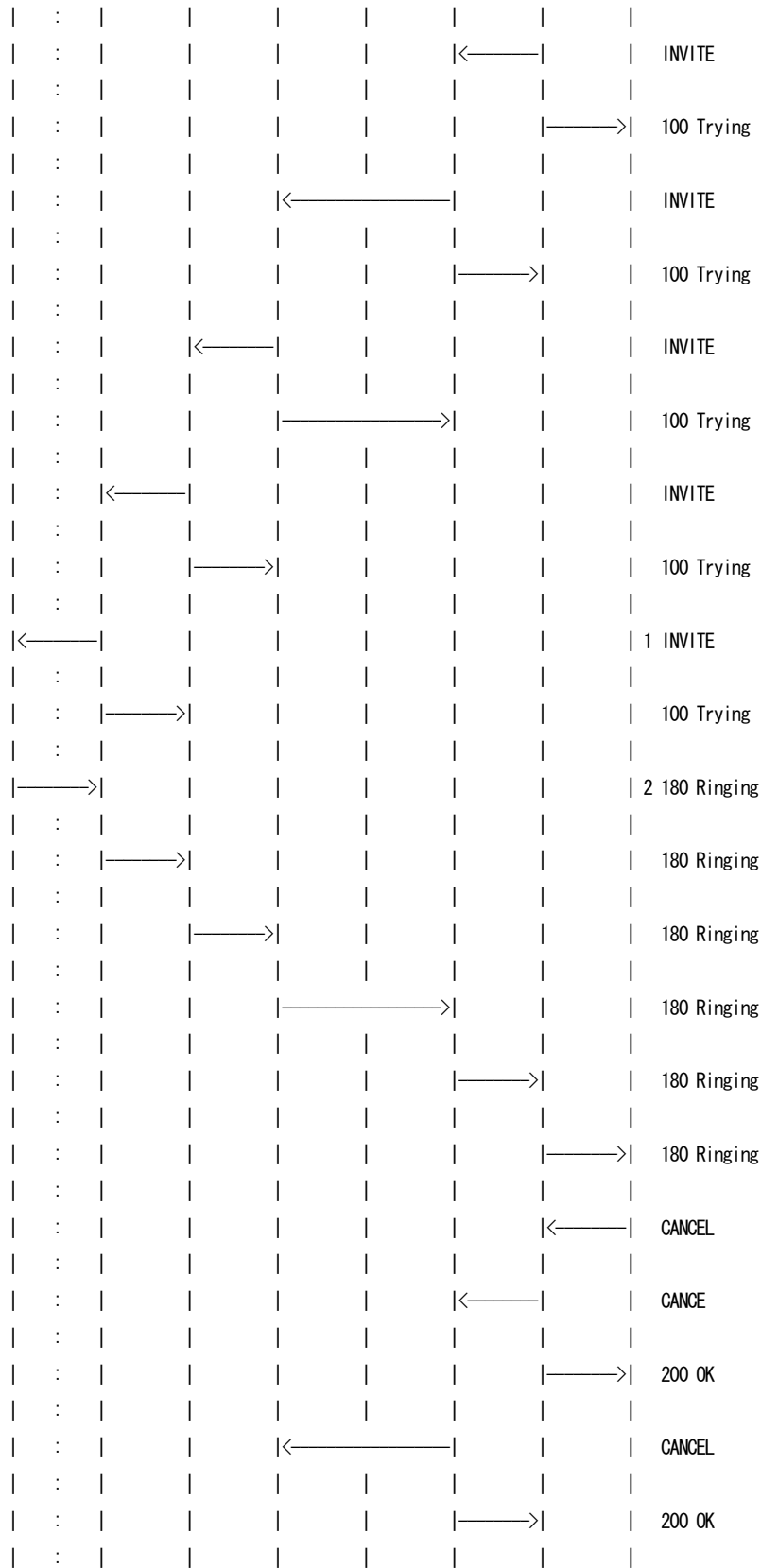

| : | |<-----| | | | | | | CANCEL
| : | | | | | | | | | | | |
| : | | | |----->| | | | | | | 200 OK
| : | | | | | | | | | | | | |
| : |<-----| | | | | | | | | | | CANCEL
| : | | | | | | | | | | | | |
| : | | | |----->| | | | | | | | | | 200 OK
| : | | | | | | | | | | | | | |
|<-----| | | | | | | | | | | | 3 CANCEL
| : | | | | | | | | | | | | | |

-----Timer J Start

| : | | | | | | | | | | | | | | |
| : | |----->| | | | | | | | | | | 200 OK
| : | | | | | | | | | | | | | | |
|----->| | | | | | | | | | | | | | | 4 200 OK
| : | | | | | | | | | | | | | | | |
|<-----| | | | | | | | | | | | | | | | CANCEL
| : | | | | | | | | | | | | | | | |
|----->| | | | | | | | | | | | | | | | 200 OK
| : | | | | | | | | | | | | | | | |
|<-----| | | | | | | | | | | | | | | | CANCEL
| : | | | | | | | | | | | | | | | |
|----->| | | | | | | | | | | | | | | | 200 OK
| : | | | | | | | | | | | | | | | |

-----Timer J (128 sec) fired

| : | | | | | | | | | | | | | | |
|<-----| | | | | | | | | | | | | | | | 5 CANCEL
| : | | | | | | | | | | | | | | | |
|----->| | | | | | | | | | | | | | | | 6 481 Transaction Does Not Exist (*1)
| : | | | | | | | | | | | | | | | |

- 1 NUT receives INVITE
- 2 NUT sends 180 Ringing
- 3 NUT receives CANCEL
- 4 NUT sends 200 OK
- 5 NUT receives CANCEL
- 6 NUT sends 481 Transaction Does Not Exist

=== Message example ===

1. INVITE P-CSCF -> NUT

INVITE sip:UEa1_public_1@node.under.test.com:1357 SIP/2.0



Via: SIP/2.0/UDP p.a1.under.test.com:10001;branch=z9hG4bK431e418c233,
SIP/2.0/UDPs.a1.under.test.com;branch=z9hG4bK431e418c4.2;received=3ffe:501:ffff:100::30,
SIP/2.0/UDP i.a1.under.test.com;branch=z9hG4bKnashds418c5a;received=3ffe:501:ffff:100::20,
SIP/2.0/UDP s.a2.under.test.com;branch=z9hG4bK721e418c657u;received=3ffe:501:ffff:200::30,
SIP/2.0/UDP p.a2.under.test.com;branch=z9hG4bKnaghc45ca8;received=3ffe:501:ffff:200::10,
SIP/2.0/UDP [3ffe:501:ffff:2000::1000]:22222;branch=z9hG4bKnashds45ba91
Record-Route: <sip:p.a1.under.test.com:10001;lr>,<sip:s.a1.under.test.com;lr>,
<sip:s.a2.under.test.com;lr>,<sip:p.a2.under.test.com;lr>
Max-Forwards: 65
From: <sip:UEa2_public_1@under.test.com>;tag=10fxcde76sl
To: <sip:UEa1_public_1@under.test.com>
Call-ID: 3848276298220188511@under.test.com
CSeq: 1 INVITE
Contact: <sip:UEa2_public_1@nodea2.under.test.com:22222>
Supported:
Allow: INVITE,ACK,CANCEL,OPTIONS,BYE
Allow-Events: reg
Accept: application/sdp,application/3gpp-ims+xml
P-Called-Party-ID: <sip:UEa1_public_1@under.test.com>
Content-Type: application/sdp
Content-Length: 154

v=0
o=UEa2 2890844526 2890844526 IN IP6 nodea2.under.test.com
s=-
c=IN IP6 nodea2.under.test.com
t=0 0
m=audio 49172 RTP/AVP 0
b=AS:75
a=rtpmap:0 PCMU/8000

2. 180 Ringing NUT -> P-CSCF

SIP/2.0 180 Ringing

Via: SIP/2.0/UDP p.a1.under.test.com:10001;branch=z9hG4bK431e418c233;
received=3ffe:501:ffff:100::10,SIP/2.0/UDP s.a1.under.test.com;branch=z9hG4bK431e418c4.2;
received=3ffe:501:ffff:100::30,SIP/2.0/UDP i.a1.under.test.com;branch=z9hG4bKnashds418c5a;
received=3ffe:501:ffff:100::20,SIP/2.0/UDP s.a2.under.test.com;branch=z9hG4bK721e418c657u;
received=3ffe:501:ffff:200::30,SIP/2.0/UDP p.a2.under.test.com;branch=z9hG4bKnaghc45ca8;
received=3ffe:501:ffff:200::10,SIP/2.0/UDP [3ffe:501:ffff:2000::1000]:22222;branch=z9hG4bKnashds45ba91
From: <sip:UEa2_public_1@under.test.com>;tag=10fxcde76sl
To: <sip:UEa1_public_1@under.test.com>;tag=414259
Call-ID: 3848276298220188511@under.test.com



CSeq: 1 INVITE
Content-Length: 0

3. CANCEL P-CSCF -> NUT

CANCEL sip:UEa1_public_1@node.under.test.com:1357 SIP/2.0
Via: SIP/2.0/UDP p.a1.under.test.com:10001;branch=z9hG4bK431e418c233
Max-Forwards: 70
From: <sip:UEa2_public_1@under.test.com>;tag=10fxced76sl
To: <sip:UEa1_public_1@under.test.com>
Call-ID: 3848276298220188511@under.test.com
CSeq: 1 CANCEL
Content-Length: 0

4. 200 OK NUT -> P-CSCF

SIP/2.0 200 OK
Via: SIP/2.0/UDP p.a1.under.test.com:10001;branch=z9hG4bK431e418c233;received=3ffe:501:ffff:100::10
From: <sip:UEa2_public_1@under.test.com>;tag=10fxced76sl
To: <sip:UEa1_public_1@under.test.com>;tag=314160
Call-ID: 3848276298220188511@under.test.com
CSeq: 1 CANCEL
Content-Length: 0

5. CANCEL P-CSCF -> NUT

CANCEL sip:UEa1_public_1@node.under.test.com:1357 SIP/2.0
Via: SIP/2.0/UDP p.a1.under.test.com:10001;branch=z9hG4bK431e418c233
Max-Forwards: 70
From: <sip:UEa2_public_1@under.test.com>;tag=10fxced76sl
To: <sip:UEa1_public_1@under.test.com>
Call-ID: 3848276298220188511@under.test.com
CSeq: 1 CANCEL
Content-Length: 0

6. 481 Transaction Does Not Exist NUT -> P-CSCF

SIP/2.0 481 Transaction Does Not Exist
Via: SIP/2.0/UDP p.a1.under.test.com:10001;branch=z9hG4bK431e418c233;received=3ffe:501:ffff:100::10
From: <sip:UEa2_public_1@under.test.com>;tag=10fxced76sl
To: <sip:UEa1_public_1@under.test.com>;tag=314163
Call-ID: 3848276298220188511@under.test.com
CSeq: 1 CANCEL



Content-Length: 0

[OBSERVABLE RESULTS]

*1: 6 481 Transaction Does Not Exist from NUT to P-CSCF.

See generic_3XX-6XX

- Exception{

* To

If a request contained a To tag in the request, the To header field in the response MUST equal that of the request. [RFC3261-8.2-41]

The same tag MUST be used for all responses to that request, both final and provisional. [RFC3261-8.2-44]

}

The UAS SHOULD respond to the CANCEL with a 481 (Call Transaction Does Not Exist). [RFC3261-9.2-1]

4.5.5 UE-TM-B-5-AKA - Timer F expiration (In Session)

[NAME]

UE-TM-B-5-AKA - Timer F expiration (In Session)

[TARGET]

IMS User Equipment (NUT)

[PURPOSE]

To verify that UEa1 properly stops sending CANCEL after timer F expired.

[REFERENCE]

TS24.229 7.7

RFC3261 17.1.2.2

[REQUIREMENT]

NONE



[PARAMETER(NUT)]

public-user-id : sip:UEa1_public_1@under.test.com
private-user-id : UEa1_private@under.test.com
contact_URI : sip:UEa1_public_1@node.under.test.com
HOMENETWORK Domain : sip:under.test.com

[PARAMETER(TESTER)]

public-user-id(UEa2) : sip:UEa2_public_1@under.test.com
P-CSCFa1 : sip:p.a1.under.test.com

[ADDRESS]

UEa1(NUT) : 3ffe:501:ffff:1000::1000
Router(R1) : 3ffe:501:ffff:1000::1
P-CSCFa1 : 3ffe:501:fff:100::10
I-CSCFa1 : 3ffe:501:fff:100::20
S-CSCFa1 : 3ffe:501:fff:100::30
DNS : 3ffe:501:fff:100::40
DHCP : 3ffe:501:fff:100::50

UEa2 : 3ffe:501:fff:2000::1000
P-CSCFa2 : 3ffe:501:fff:200::10
I-CSCFa2 : 3ffe:501:fff:200::20
S-CSCFa2 : 3ffe:501:fff:200::30

[TOPOLOGY]

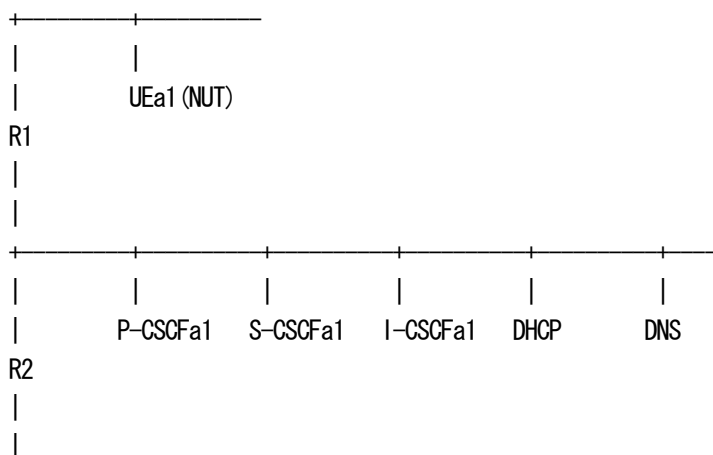

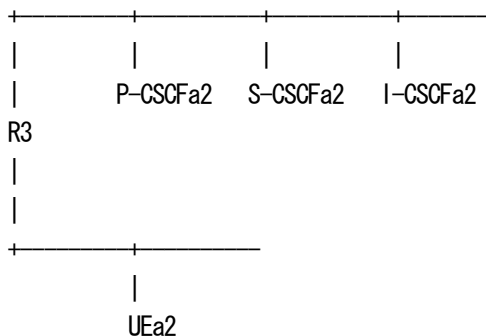

[INITIALIZATION]

UEa1(NUT) must be registered with the tester by executing the scenario "UE-INI-B-1-AKA".

For details of "UE-INI-B-1-AKA", refer to the profile "UE-RG-B-1-AKA".

[PROCEDURE]

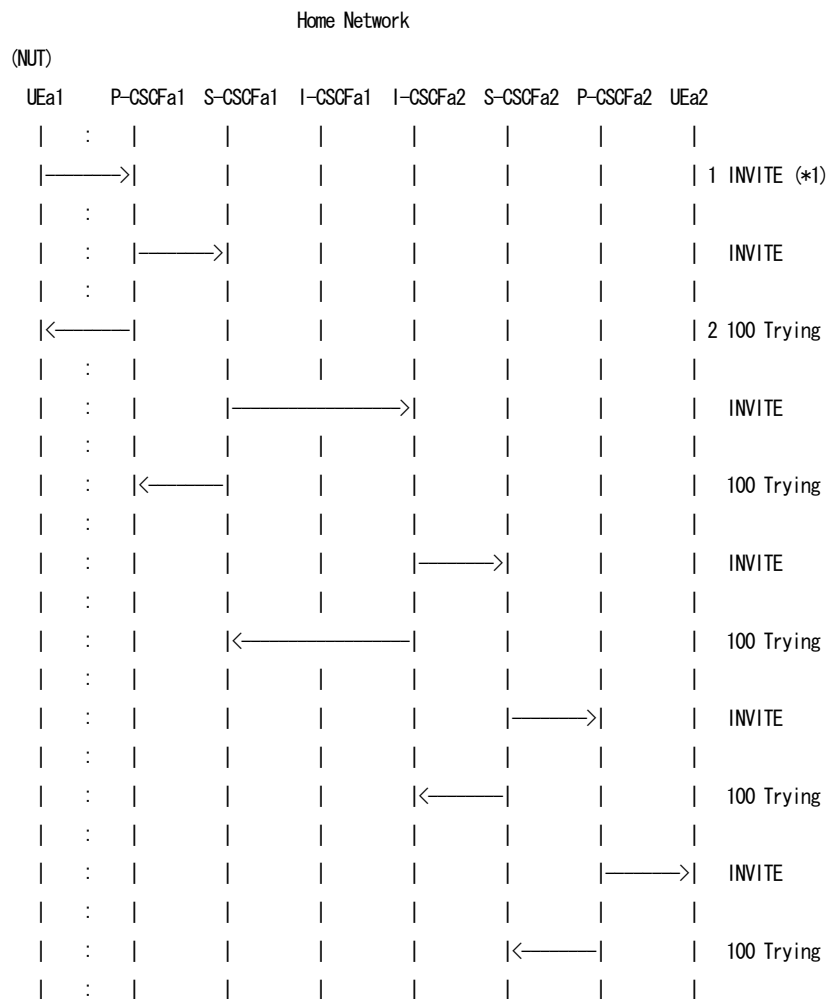

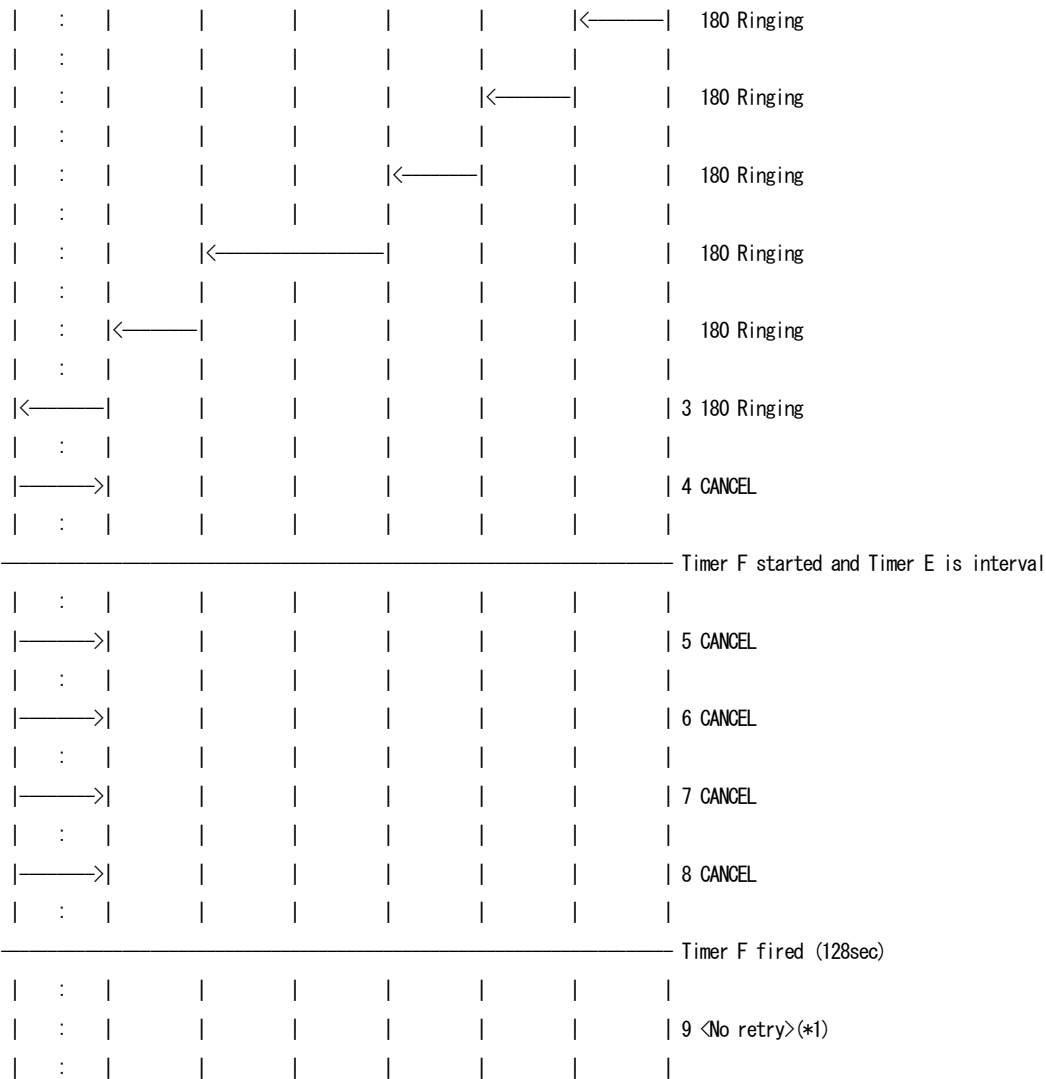

- 1 NUT sends INVITE
- 2 NUT receives 100 Trying
- 3 NUT receives 180 Ringing
- 4-8 NUT send CANCEL
- 9 <No retry>

=== Message example ===

1. INVITE NUT -> P-CSCF
INVITE sip:UEa2_public_1@under.test.com SIP/2.0
Via: SIP/2.0/UDP [3ffe:501:ffff:1000::1000]:1357;branch=z9hG4bK74bf9
Route: <sip:p.a1.under.test.com:10001;lr>,<sip:orig@s.a1.under.test.com;lr>
Max-Forwards: 70



From: <sip:UEa1_public_1@under.test.com>;tag=9fxced76sl
To: <sip:UEa2_public_1@under.test.com>
Call-ID: 3848276298220188511@under.test.com
CSeq: 1 INVITE
Contact: <sip:UEa1_public_1@node.under.test.com:1357>
Supported:
Allow: INVITE,ACK,CANCEL,OPTIONS,BYE
Allow-Events: reg
Accept: application/sdp,application/3gpp-ims+xml
Require: sec-agree
Proxy-Require: sec-agree
Security-Verify: ipsec-3gpp; alg=hmac-sha-1-96; spi-c=256;spi-s=257; port-c=10002; port-s=10001
Content-Type: application/sdp
Content-Length: 154

v=0
o=UEa1 2890844526 2890844526 IN IP6 node.under.test.com
s=-
c=IN IP6 node.under.test.com
t=0 0
m=audio 49172 RTP/AVP 0
b=AS:75
a=rtpmap:0 PCMU/8000

2. 100 Trying P-CSCF -> NUT

SIP/2.0 100 Trying

Via: SIP/2.0/UDP [3ffe:501:ffff:1000::1000]:1357;branch=z9hG4bK74bf9

From: <sip:UEa1_public_1@under.test.com>;tag=9fxced76sl

To: <sip:UEa2_public_1@under.test.com>

Call-ID: 3848276298220188511@under.test.com

CSeq: 1 INVITE

Content-Length: 0

3. 180 Ringing P-CSCF -> NUT

SIP/2.0 180 Ringing

Via: SIP/2.0/UDP [3ffe:501:ffff:1000::1000]:1357;branch=z9hG4bK74bf9

From: <sip:UEa1_public_1@under.test.com>;tag=9fxced76sl

To: <sip:UEa2_public_1@under.test.com>;tag=314259

Call-ID: 3848276298220188511@under.test.com

CSeq: 1 INVITE

Content-Length: 0



4-8. CANCEL NUT -> P-CSCF

CANCEL sip:UEa2_public_1@under.test.com SIP/2.0

Via: SIP/2.0/UDP [3ffe:501:ffff:1000::1000]:1357;branch=z9hG4bK74bf9

Route: <sip:p.a1.under.test.com:10001;lr>,<sip:orig@s.a1.under.test.com;lr>

Max-Forwards: 70

From: <sip:UEa1_public_1@under.test.com>;tag=9fxced76sl

To: <sip:UEa2_public_1@under.test.com>

Call-ID: 3848276298220188511@under.test.com

CSeq: 1 CANCEL

Content-Length: 0

9. <No retry>

[OBSERVABLE RESULTS]

*1: 9 No retry

4.6 Sending Response

4.6.1 UE-SR-B-1-AKA - Sending 400 response

[NAME]

UE-SR-B-1-AKA - Sending 400 response.

[TARGET]

IMS User Equipment (NUT)

[PURPOSE]

To verify that UEa1 sends 400(Bad Request) response to illegal INVITE request that included SDP and Content-Length header with the value 0.

[REFERENCE]

TS24.229 A.2.1.4.1

RFC3261 18.3



[REQUIREMENT]

NONE

[PARAMETER(NUT)]

public-user-id : sip:UEa1_public_1@under.test.com
private-user-id : UEa1_private@under.test.com
contact_URI : sip:UEa1_public_1@node.under.test.com
HOMENETWORK Domain : sip:under.test.com

[PARAMETER(TESTER)]

public-user-id(UEa2) : sip:UEa2_public_1@under.test.com
P-CSCFa1 : sip:p.a1.under.test.com

[ADDRESS]

UEa1(NUT) : 3ffe:501:ffff:1000::1000
Router(R1) : 3ffe:501:ffff:1000::1
P-CSCFa1 : 3ffe:501:ffff:100::10
I-CSCFa1 : 3ffe:501:ffff:100::20
S-CSCFa1 : 3ffe:501:ffff:100::30
DNS : 3ffe:501:ffff:100::40
DHCP : 3ffe:501:ffff:100::50

UEa2 : 3ffe:501:ffff:2000::1000
P-CSCFa2 : 3ffe:501:ffff:200::10
I-CSCFa2 : 3ffe:501:ffff:200::20
S-CSCFa2 : 3ffe:501:ffff:200::30

[TOPOLOGY]

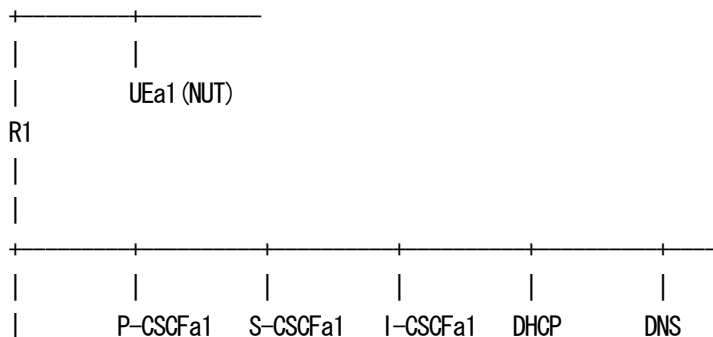

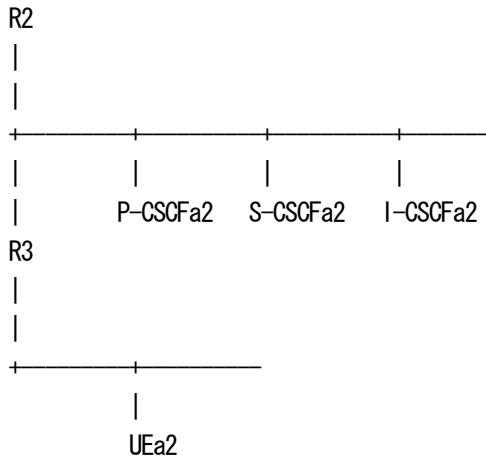

[INITIALIZATION]

UEa1(NUT) must be registered with the tester by executing the scenario "UE-INI-B-1-AKA".
 For details of "UE-INI-B-1-AKA", refer to the profile "UE-RG-B-1-AKA".

[PROCEDURE]

Home Network

(NUT)

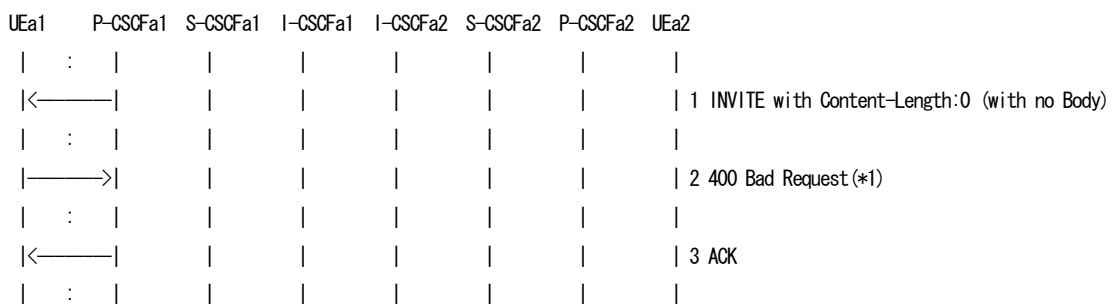

- 1 NUT receives INVITE.
- 2 NUT sends 400 Bad Request.
- 3 NUT receives ACK.

=== Message example ===

1. INVITE P-CSCF -> NUT

```

INVITE sip:UEa1_public_1@node.under.test.com:1357 SIP/2.0
Via: SIP/2.0/UDP p.a1.under.test.com:10001;branch=z9hG4bK431e418c233,
SIP/2.0/UDP s.a1.under.test.com;branch=z9hG4bK431e418c4.2;received=3ffe:501:ffff:100::30,
SIP/2.0/UDP i.a1.under.test.com;branch=z9hG4bK431e418c5a;received=3ffe:501:ffff:100::20,
  
```



SIP/2.0/UDP s.a2.under.test.com;branch=z9hG4bK721e418c657u;received=3ffe:501:ffff:200::30,
SIP/2.0/UDP p.a2.under.test.com;branch=z9hG4bKnaghc45ca8;received=3ffe:501:ffff:200::10,
SIP/2.0/UDP [3ffe:501:ffff:2000::1000]:22222;branch=z9hG4bKnashds45ba91
Record-Route: <sip:p.a1.under.test.com:10001;lr>,<sip:s.a1.under.test.com;lr>,
<sip:s.a2.under.test.com;lr>,<sip:p.a2.under.test.com;lr>
Max-Forwards: 65
From: <sip:UEa2_public_1@under.test.com>;tag=10fxced76sl
To: <sip:UEa1_public_1@under.test.com>
Call-ID: 3848276298220188511@under.test.com
CSeq: 1 INVITE
Contact: <sip:UEa2_public_1@nodea2.under.test.com:22222>
Supported:
Allow: INVITE,ACK,CANCEL,OPTIONS,BYE
Allow-Events: reg
Accept: application/sdp,application/3gpp-ims+xml
P-Called-Party-ID: <sip:UEa1_public_1@under.test.com>
Content-Type: application/sdp
Content-Length: 0

v=0
o=UEa2 2890844526 2890844526 IN IP6 nodea2.under.test.com
s=-
c=IN IP6 nodea2.under.test.com
t=0 0
m=audio 49172 RTP/AVP 0
b=AS:75
a=rtpmap:0 PCMU/8000

2. 400 Bad Request NUT -> P-CSCF

SIP/2.0 400 Bad Request

Via: SIP/2.0/UDP p.a1.under.test.com:10001;branch=z9hG4bK431e418c233;
received=3ffe:501:ffff:100::10,SIP/2.0/UDP s.a1.under.test.com;branch=z9hG4bK431e418c4.2;
received=3ffe:501:ffff:100::30,SIP/2.0/UDP i.a1.under.test.com;branch=z9hG4bKnashds418c5a;
received=3ffe:501:ffff:100::20,SIP/2.0/UDP s.a2.under.test.com;branch=z9hG4bK721e418c657u;
received=3ffe:501:ffff:200::30,SIP/2.0/UDP p.a2.under.test.com;branch=z9hG4bKnaghc45ca8;
received=3ffe:501:ffff:200::10,SIP/2.0/UDP [3ffe:501:ffff:2000::1000]:22222;branch=z9hG4bKnashds45ba91
From: <sip:UEa2_public_1@under.test.com>;tag=10fxced76sl
To: <sip:UEa1_public_1@under.test.com>;tag=414259
Call-ID: 3848276298220188511@under.test.com
CSeq: 1 INVITE
Content-Length: 0



3. ACK P-CSCF -> NUT

ACK sip:UEa1_public_1@node.under.test.com:1357 SIP/2.0

Via: SIP/2.0/UDP p.a1.under.test.com:10001;branch=z9hG4bK431e418c233

Max-Forwards: 65

From: <sip:UEa2_public_1@under.test.com>;tag=10fxced76sl

To: <sip:UEa1_public_1@under.test.com>;tag=414259

Call-ID: 3848276298220188511@under.test.com

CSeq: 1 ACK

Content-Length: 0

[OBSERVABLE RESULTS]

*1: 2 400 Bad Request from NUT to P-CSCF.

See generic_3XX-6XX

- Exception{

* To

If a request contained a To tag in the request, the To header field in the response MUST equal that of the request. [RFC3261-8.2-41]

The same tag MUST be used for all responses to that request, both final and provisional. [RFC3261-8.2-44])

}

4.6.2 UE-SR-B-2-AKA - Sending 404 response

[NAME]

UE-SR-B-2-AKA - Sending 404 response

[TARGET]

IMS User Equipment (NUT)

[PURPOSE]

To verify that UEa1 sends 404 (Not Found) response to INVITE that has other destination Request-URI.



[REFERENCE]

TS24.229 A.2.1.4.1

RFC3261 8.2.2.1

[REQUIREMENT]

NONE

[PARAMETER(NUT)]

```
public-user-id      :      sip:UEa1_public_1@under.test.com
private-user-id     :      UEa1_private@under.test.com
contact_URI         :      sip:UEa1_public_1@node.under.test.com
HOMENETWORK Domain :      sip.under.test.com
```

[PARAMETER(TESTER)]

```
public-user-id(UEa2) :      sip:UEa2_public_1@under.test.com
P-CSCFa1             :      sip:p.a1.under.test.com
```

[ADDRESS]

```
UEa1(NUT)           :      3ffe:501:fff:1000::1000
Router(R1)          :      3ffe:501:fff:1000::1
P-CSCFa1             :      3ffe:501:fff:100::10
I-CSCFa1             :      3ffe:501:fff:100::20
S-CSCFa1             :      3ffe:501:fff:100::30
DNS                  :      3ffe:501:fff:100::40
DHCP                 :      3ffe:501:fff:100::50

UEa2                 :      3ffe:501:fff:2000::1000
P-CSCFa2             :      3ffe:501:fff:200::10
I-CSCFa2             :      3ffe:501:fff:200::20
S-CSCFa2             :      3ffe:501:fff:200::30
```

[TOPOLOGY]

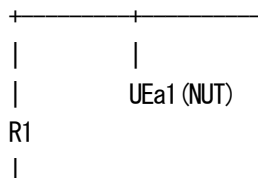

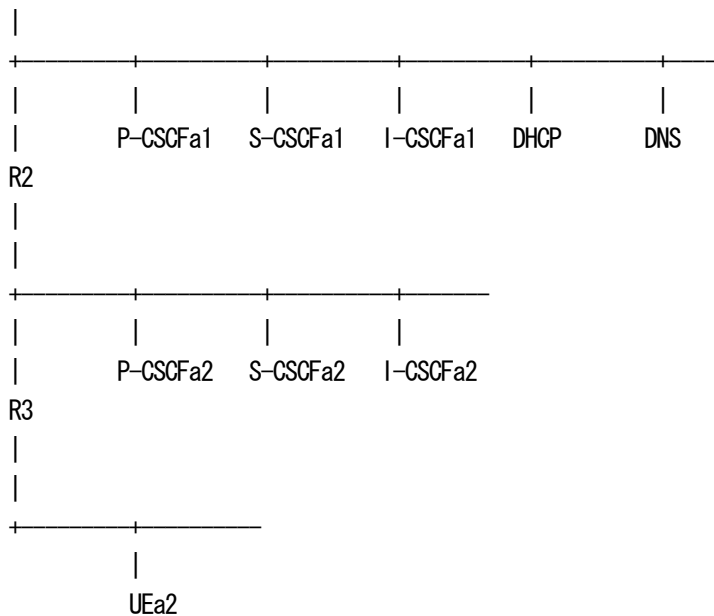

[INITIALIZATION]

UEa1(NUT) must be registered with the tester by executing the scenario "UE-INI-B-1-AKA".
 For details of "UE-INI-B-1-AKA", refer to the profile "UE-RG-B-1-AKA".

[PROCEDURE]

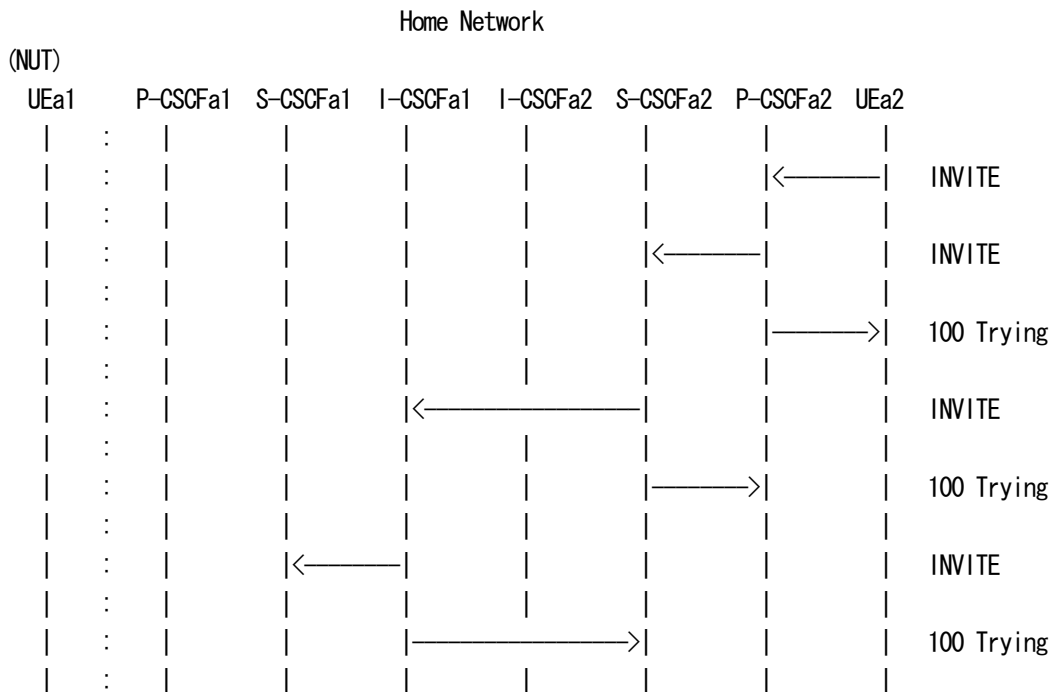

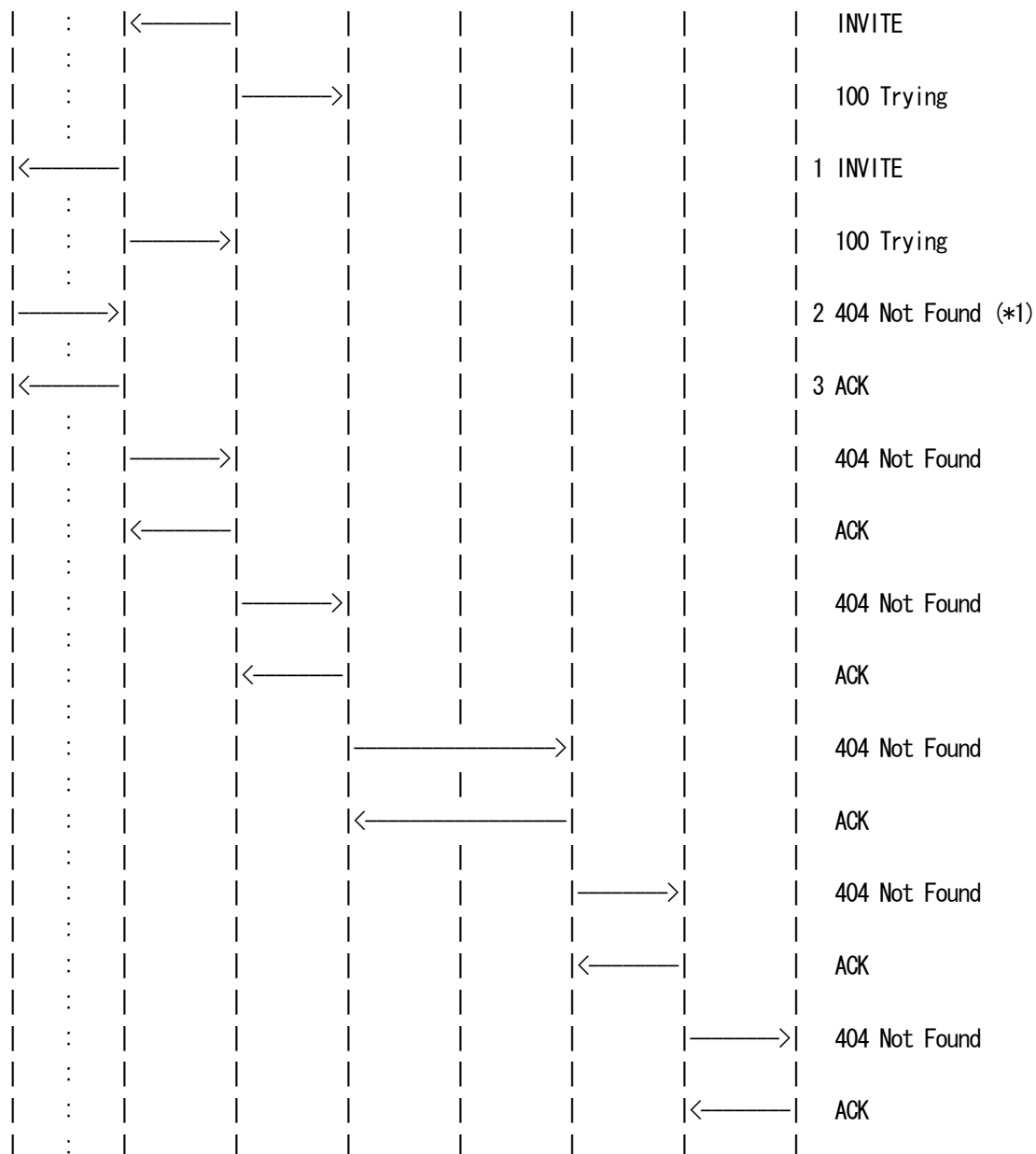

- 1 NUT receives INVITE.
- 2 NUT sends 404 Not Found.
- 3 NUT receives ACK.

=== Message example ===

1. INVITE P-CSCF -> NUT

INVITE sip:UEa1_public_1@nooode.under.test.com:1357 SIP/2.0



Via: SIP/2.0/UDP p.a1.under.test.com:10001;branch=z9hG4bK431e418c233,
SIP/2.0/UDP s.a1.under.test.com;branch=z9hG4bK431e418c4.2;received=3ffe:501:ffff:100::30,
SIP/2.0/UDP i.a1.under.test.com;branch=z9hG4bKnashds418c5a;received=3ffe:501:ffff:100::20,
SIP/2.0/UDP s.a2.under.test.com;branch=z9hG4bK721e418c657u;received=3ffe:501:ffff:200::30,
SIP/2.0/UDP p.a2.under.test.com;branch=z9hG4bKnaghc45ca8;received=3ffe:501:ffff:200::10,
SIP/2.0/UDP [3ffe:501:ffff:2000::1000]:22222;branch=z9hG4bKnashds45ba91
Record-Route: <sip:p.a1.under.test.com:10001;lr>,<sip:s.a1.under.test.com;lr>,
<sip:s.a2.under.test.com;lr>,<sip:p.a2.under.test.com;lr>
Max-Forwards: 65
From: <sip:UEa2_public_1@under.test.com>;tag=10fxcde76sl
To: <sip:UEa1_public_1@under.test.com>
Call-ID: 3848276298220188511@under.test.com
CSeq: 1 INVITE
Contact: <sip:UEa2_public_1@nodea2.under.test.com:22222>
Supported:
Allow: INVITE,ACK,CANCEL,OPTIONS,BYE
Allow-Events: reg
Accept: application/sdp,application/3gpp-ims+xml
P-Called-Party-ID: <sip:UEa1_public_1@under.test.com>
Content-Type: application/sdp
Content-Length: 154

v=0
o=UEa2 2890844526 2890844526 IN IP6 nodea2.under.test.com
s=-
c=IN IP6 nodea2.under.test.com
t=0 0
m=audio 49172 RTP/AVP 0
b=AS:75
a=rtpmap:0 PCMU/8000

2. 404 Not Found NUT -> P-CSCF

SIP/2.0 404 Not Found

Via: SIP/2.0/UDP p.a1.under.test.com:10001;branch=z9hG4bK431e418c233;
received=3ffe:501:ffff:100::10,SIP/2.0/UDP s.a1.under.test.com;branch=z9hG4bK431e418c4.2;
received=3ffe:501:ffff:100::30,SIP/2.0/UDP i.a1.under.test.com;branch=z9hG4bKnashds418c5a;
received=3ffe:501:ffff:100::20,SIP/2.0/UDP s.a2.under.test.com;branch=z9hG4bK721e418c657u;
received=3ffe:501:ffff:200::30,SIP/2.0/UDP p.a2.under.test.com;branch=z9hG4bKnaghc45ca8;
received=3ffe:501:ffff:200::10,SIP/2.0/UDP [3ffe:501:ffff:2000::1000]:22222;branch=z9hG4bKnashds45ba91
From: <sip:UEa2_public_1@under.test.com>;tag=10fxcde76sl
To: <sip:UEa1_public_1@under.test.com>;tag=414259
Call-ID: 3848276298220188511@under.test.com



CSeq: 1 INVITE
Content-Length: 0

3. ACK P-CSCF -> NUT

ACK sip:UEa1_public_1@noooooode.under.test.com:1357 SIP/2.0
Via: SIP/2.0/UDP p.a1.under.test.com:10001;branch=z9hG4bK431e418c233
Max-Forwards: 65
From: <sip:UEa2_public_1@under.test.com>;tag=10fxced76sl
To: <sip:UEa1_public_1@under.test.com>;tag=414259
Call-ID: 3848276298220188511@under.test.com
CSeq: 1 ACK
Content-Length: 0

[OBSERVABLE RESULTS]

*1: 2 404 Not Found from NUT to P-CSCF.

See generic_3XX-6XX

- Exception{

* To

If a request contained a To tag in the request, the To header field
in the response MUST equal that of the request. [RFC3261-8.2-41]

The same tag MUST be used for all responses to that request, both
final and provisional. [RFC3261-8.2-44])

}

4.6.3 UE-SR-B-3-AKA - Sending 405 response

[NAME]

UE-SR-B-3-AKA - Sending 405 response.

[TARGET]

IMS User Equipment (NUT)

[PURPOSE]

To verify that UEa1 sends 405 (Method Not Allowed) response to REGISTER request.



[REFERENCE]

TS24.229 A.2.1.4.1

RFC3261 8.2.1

[REQUIREMENT]

NONE

[PARAMETER(NUT)]

public-user-id : sip:UEa1_public_1@under.test.com
private-user-id : UEa1_private@under.test.com
contact_URI : sip:UEa1_public_1@node.under.test.com
HOMENETWORK Domain : sip:under.test.com

[PARAMETER(TESTER)]

public-user-id(UEa2) : sip:UEa2_public_1@under.test.com
P-CSCFa1 : sip:p.a1.under.test.com

[ADDRESS]

UEa1(NUT) : 3ffe:501:fff:1000::1000
Router(R1) : 3ffe:501:fff:1000::1
P-CSCFa1 : 3ffe:501:fff:100::10
I-CSCFa1 : 3ffe:501:fff:100::20
S-CSCFa1 : 3ffe:501:fff:100::30
DNS : 3ffe:501:fff:100::40
DHCP : 3ffe:501:fff:100::50

UEa2 : 3ffe:501:fff:2000::1000
P-CSCFa2 : 3ffe:501:fff:200::10
I-CSCFa2 : 3ffe:501:fff:200::20
S-CSCFa2 : 3ffe:501:fff:200::30

[TOPOLOGY]

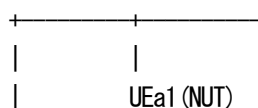

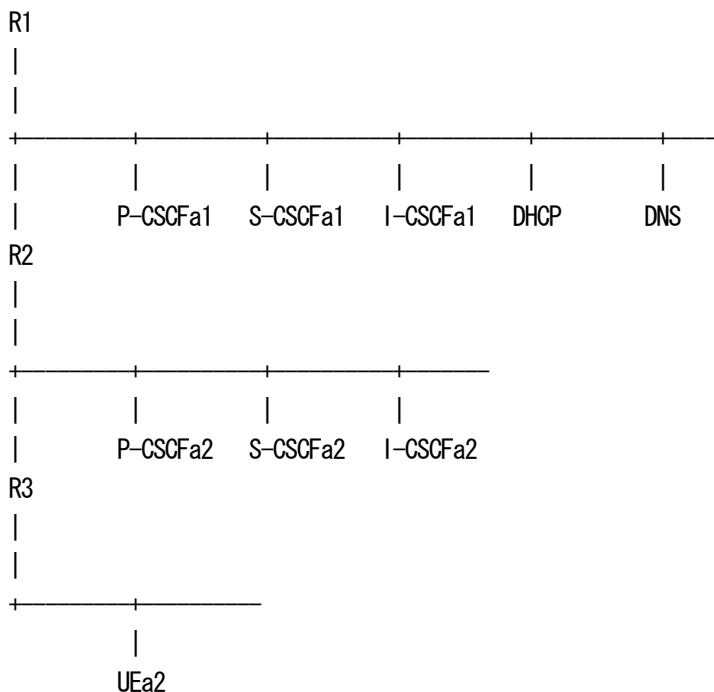

[INITIALIZATION]

UEa1(NUT) must be registered with the tester by executing the scenario "UE-INI-B-1-AKA".
 For details of "UE-INI-B-1-AKA", refer to the profile "UE-RG-B-1-AKA".

[PROCEDURE]

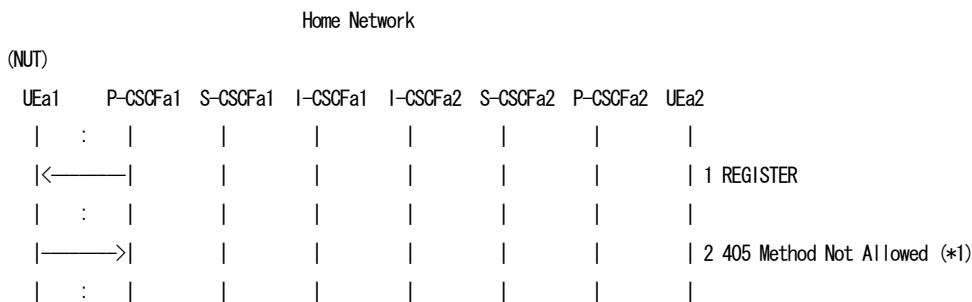

- 1 NUT receives REGISTER.
- 2 NUT sends 405 Method Not Allowed.

=== Message example ===

1. REGISTER P-CSCF -> NUT
 REGISTER sip:under.test.com SIP/2.0



Via: SIP/2.0/UDP p.a1.under.test.com:10001;branch=z9hG4bK431e418c233,
SIP/2.0/UDP [3ffe:501:ffff:2000::1000];22222;branch=z9hG4bK431e418c233
Max-Forwards: 69
Authorization: Digest username="UEa2_private@under.test.com", realm="under.test.com",
nonce="", uri="sip:under.test.com", response="", integrity-protected="no"
From: <sip:UEa2_public_1@under.test.com>;tag=4fa3
To: <sip:UEa2_public_1@under.test.com>
Contact: <sip:UEa2_public_1@nodea2.under.test.com:22222>;expires=600000
Call-ID: apb03a0s09dkjdfglkj49111@under.test.com
CSeq: 1 REGISTER
Require: path
Supported: path
Path: <sip:term@p.a1.under.test.com;lr>
Content-Length: 0

2. 405 Method Not Allowed NUT -> P-CSCF

SIP/2.0 405 Method Not Allowed

Via: SIP/2.0/UDP p.a1.under.test.com:10001;branch=z9hG4bK431e418c233;
received=3ffe:501:ffff:100::10,SIP/2.0/UDP [3ffe:501:ffff:2000::1000];22222;branch=z9hG4bK431e418c233
From: <sip:UEa2_public_1@under.test.com>;tag=4fa3
To: <sip:UEa2_public_1@under.test.com>;tag=414259
Call-ID: apb03a0s09dkjdfglkj49111@under.test.com
CSeq: 1 REGISTER
Allow: INVITE,ACK,CANCEL,OPTIONS,BYE
Content-Length: 0

[OBSERVABLE RESULTS]

*1: 2 405 Method Not Allowed from NUT to P-CSCF.

See generic_3XX-6XX

- Exception{

* To

If a request contained a To tag in the request, the To header field
in the response MUST equal that of the request.[RFC3261-8.2-41]

The same tag MUST be used for all responses to that request, both
final and provisional. [RFC3261-8.2-44])

}



- Header Field:

The response MUST include an Allow header field containing a list of valid methods for the indicated address.[RFC3261-8.2-6][RFC3261-21.4-4]

4.6.4 UE-SR-B-4-AKA - Sending 406 response

[NAME]

UE-SR-B-4-AKA - Sending 406 response

[TARGET]

IMS User Equipment (NUT)

[PURPOSE]

To verify that UEa1 sends 406(Not Acceptable) response to illegal INVITE request that included Accept header with wrong value.

[REFERENCE]

TS24.229 A.2.1.4.1

RFC3261 21.4.7

[REQUIREMENT]

NONE

[PARAMETER(NUT)]

public-user-id : sip:UEa1_public_1@under.test.com
private-user-id : UEa1_private@under.test.com
contact_URI : sip:UEa1_public_1@node.under.test.com
HOMENETWORK Domain : sip:under.test.com

[PARAMETER(TESTER)]

public-user-id(UEa2) : sip:UEa2_public_1@under.test.com
P-CSCFa1 : sip:p.a1.under.test.com

[ADDRESS]

UEa1(NUT) : 3ffe:501:ffff:1000::1000
Router(R1) : 3ffe:501:ffff:1000::1



P-CSCFa1	:	3ffe:501:fff:100::10
I-CSCFa1	:	3ffe:501:fff:100::20
S-CSCFa1	:	3ffe:501:fff:100::30
DNS	:	3ffe:501:fff:100::40
DHCP	:	3ffe:501:fff:100::50
UEa2	:	3ffe:501:fff:2000::1000
P-CSCFa2	:	3ffe:501:fff:200::10
I-CSCFa2	:	3ffe:501:fff:200::20
S-CSCFa2	:	3ffe:501:fff:200::30

[TOPOLOGY]

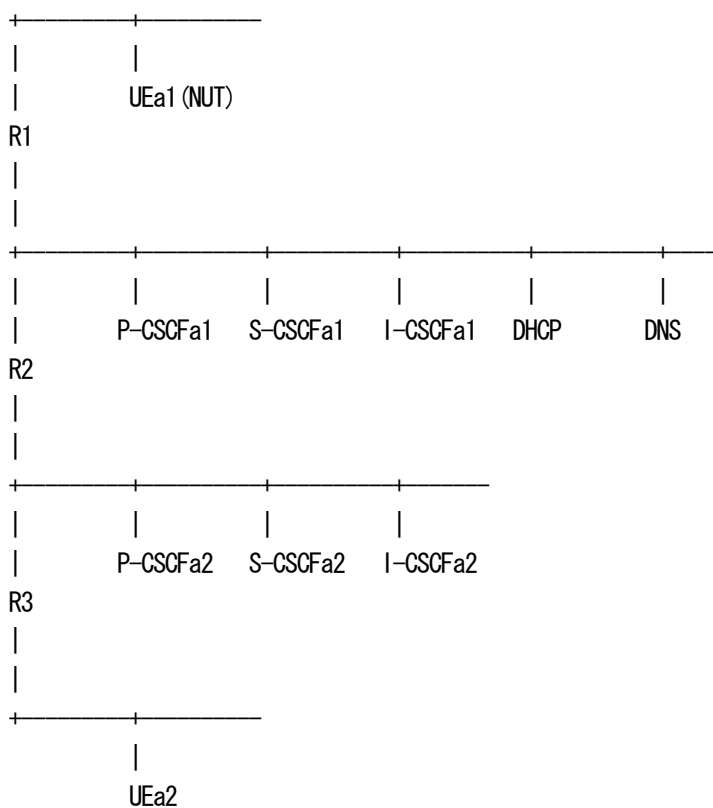

[INITIALIZATION]

UEa1(NUT) must be registered with the tester by executing the scenario "UE-INI-B-1-AKA".
For details of "UE-INI-B-1-AKA", refer to the profile "UE-RG-B-1-AKA".

[PROCEDURE]



Home Network

(NUT)

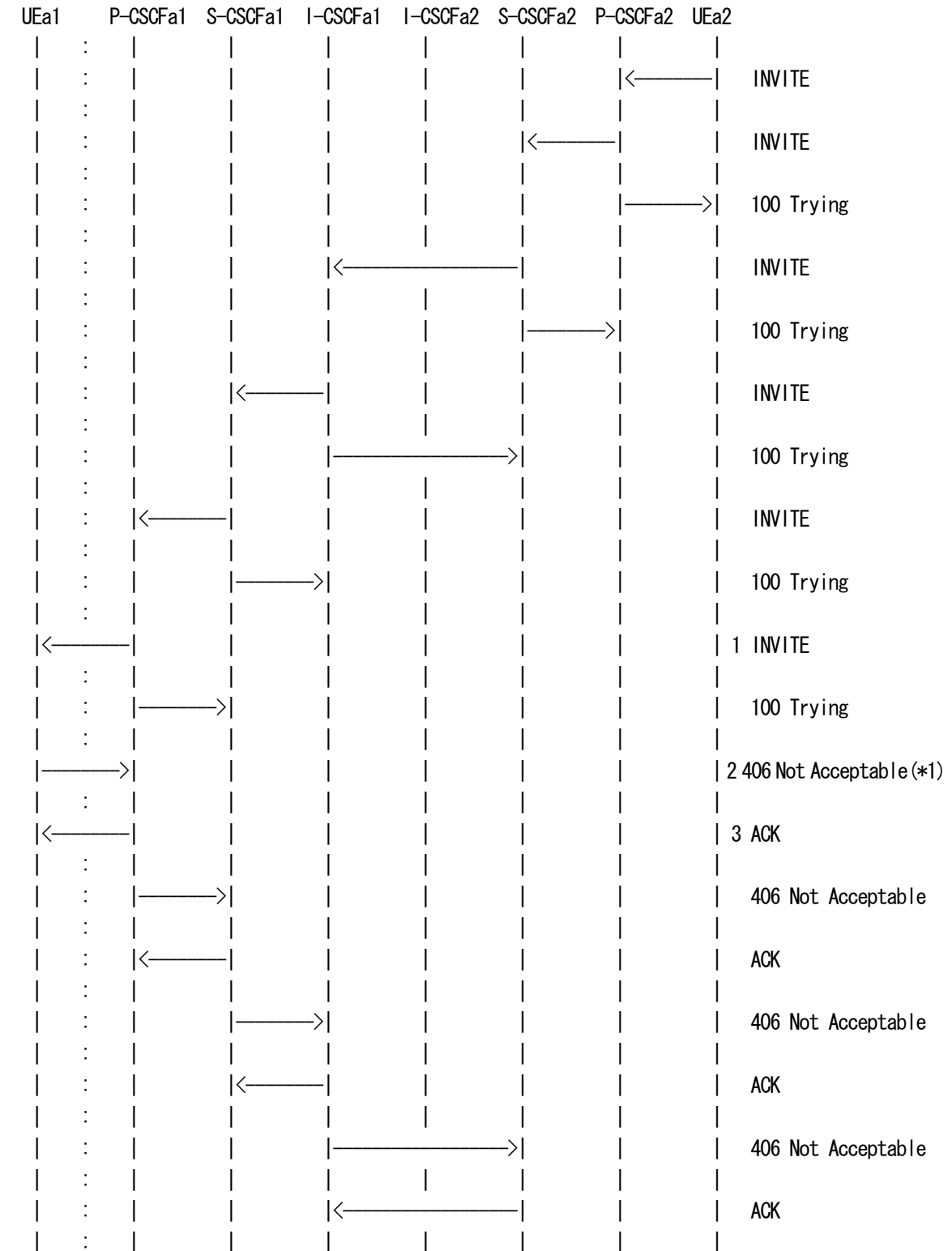

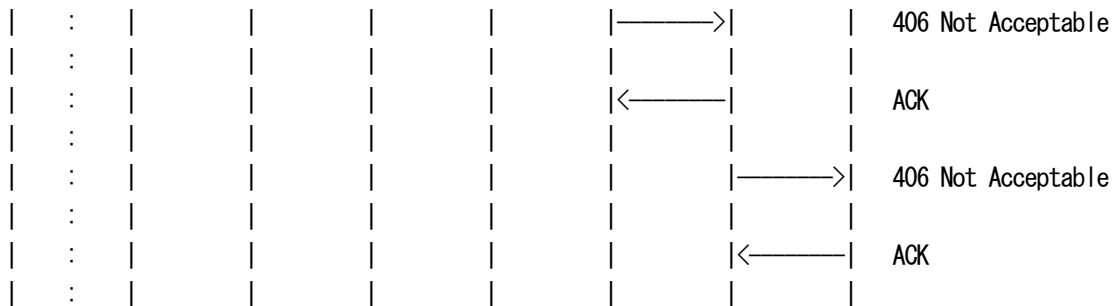

- 1 NUT receives INVITE.
- 2 NUT sends 406 Not Acceptable.
- 3 NUT receives ACK.

==== Message example ====

1. INVITE P-CSCF -> NUT

INVITE sip:UEa1_public_1@node.under.test.com:1357 SIP/2.0

Via: SIP/2.0/UDP p.a1.under.test.com:10001;branch=z9hG4bK431e418c233,
 SIP/2.0/UDP s.a1.under.test.com;branch=z9hG4bK431e418c4.2;received=3ffe:501:ffff:100::30,
 SIP/2.0/UDP i.a1.under.test.com;branch=z9hG4bKnashds418c5a;received=3ffe:501:ffff:100::20,
 SIP/2.0/UDP s.a2.under.test.com;branch=z9hG4bK721e418c657u;received=3ffe:501:ffff:200::30,
 SIP/2.0/UDP p.a2.under.test.com;branch=z9hG4bKnaghc45ca8;received=3ffe:501:ffff:200::10,
 SIP/2.0/UDP [3ffe:501:ffff:2000::1000]:22222;branch=z9hG4bKnashds45ba91
 Record-Route: <sip:p.a1.under.test.com:10001;lr>,<sip:s.a1.under.test.com;lr>,
 <sip:s.a2.under.test.com;lr>,<sip:p.a2.under.test.com;lr>

Max-Forwards: 65

From: <sip:UEa2_public_1@under.test.com>;tag=10fxced76sl

To: <sip:UEa1_public_1@under.test.com>

Call-ID: 3848276298220188511@under.test.com

CSeq: 1 INVITE

Contact: <sip:UEa2_public_1@nodea2.under.test.com:22222>

Supported:

Allow: INVITE,ACK,CANCEL,OPTIONS,BYE

Allow-Events: reg

Accept: foo/baa

P-Called-Party-ID: <sip:UEa1_public_1@under.test.com>

Content-Type: application/sdp

Content-Length: 154

v=0

o=UEa2 2890844526 2890844526 IN IP6 nodea2.under.test.com

s=-



c=IN IP6 nodea2.under.test.com
t=0 0
m=audio 49172 RTP/AVP 0
b=AS:75
a=rtpmap:0 PCMU/8000

2. 406 Not Acceptable NUT -> P-CSCF

SIP/2.0 406 Not Acceptable

Via: SIP/2.0/UDP p.a1.under.test.com:10001;branch=z9hG4bK431e418c233;
received=3ffe:501:ffff:100::10,SIP/2.0/UDP s.a1.under.test.com;branch=z9hG4bK431e418c4.2;
received=3ffe:501:ffff:100::30,SIP/2.0/UDP i.a1.under.test.com;branch=z9hG4bKnashds418c5a;
received=3ffe:501:ffff:100::20,SIP/2.0/UDP s.a2.under.test.com;branch=z9hG4bK721e418c657u;
received=3ffe:501:ffff:200::30,SIP/2.0/UDP p.a2.under.test.com;branch=z9hG4bKnaghc45ca8;
received=3ffe:501:ffff:200::10,SIP/2.0/UDP [3ffe:501:ffff:2000::1000]:22222;branch=z9hG4bKnashds45ba91
From: <sip:UEa2_public_1@under.test.com>;tag=10fxcde76sl
To: <sip:UEa1_public_1@under.test.com>;tag=414259
Call-ID: 3848276298220188511@under.test.com
CSeq: 1 INVITE
Content-Length: 0

3. ACK P-CSCF -> NUT

ACK sip:UEa1_public_1@node.under.test.com:1357 SIP/2.0
Via: SIP/2.0/UDP p.a1.under.test.com:10001;branch=z9hG4bK431e418c233
Max-Forwards: 70
From: <sip:UEa2_public_1@under.test.com>;tag=10fxcde76sl
To: <sip:UEa1_public_1@under.test.com>;tag=414259
Call-ID: 3848276298220188511@under.test.com
CSeq: 1 ACK
Content-Length: 0

[OBSERVABLE RESULTS]

*1: 2 406 Not Acceptable from NUT to P-CSCF.

See generic_3XX-6XX

- Exception{

* To

If a request contained a To tag in the request, the To header field
in the response MUST equal that of the request.[RFC3261-8.2-41]



The same tag MUST be used for all responses to that request, both final and provisional. [RFC3261-8.2-44])

}

4.6.5 UE-SR-B-5-AKA - Sending 414 response

[NAME]

UE-SR-B-5-AKA - Sending 414 response

[TARGET]

IMS User Equipment (NUT)

[PURPOSE]

To verify that UEa1 sends 414(Request-URI Too Large) response to INVITE request that included too large Request-URI for UEa1.

[REFERENCE]

TS24.229 A.2.1.4.1

RFC3261 21.4.12

[REQUIREMENT]

NONE

[PARAMETER(NUT)]

public-user-id : sip:UEa1_public_1@under.test.com

private-user-id : UEa1_private@under.test.com

contact_URI : sip:UEa1_public_1@node.under.test.com

HOMENETWORK Domain : sip:under.test.com

[PARAMETER(TESTER)]

public-user-id(UEa2) : sip:UEa2_public_1@under.test.com

P-CSCFa1 : sip:p.a1.under.test.com

[ADDRESS]



UEa1(NUT)	:	3ffe:501:fff:1000::1000
Router(R1)	:	3ffe:501:fff:1000::1
P-CSCFa1	:	3ffe:501:fff:100::10
I-CSCFa1	:	3ffe:501:fff:100::20
S-CSCFa1	:	3ffe:501:fff:100::30
DNS	:	3ffe:501:fff:100::40
DHCP	:	3ffe:501:fff:100::50
UEa2	:	3ffe:501:fff:2000::1000
P-CSCFa2	:	3ffe:501:fff:200::10
I-CSCFa2	:	3ffe:501:fff:200::20
S-CSCFa2	:	3ffe:501:fff:200::30

[TOPOLOGY]

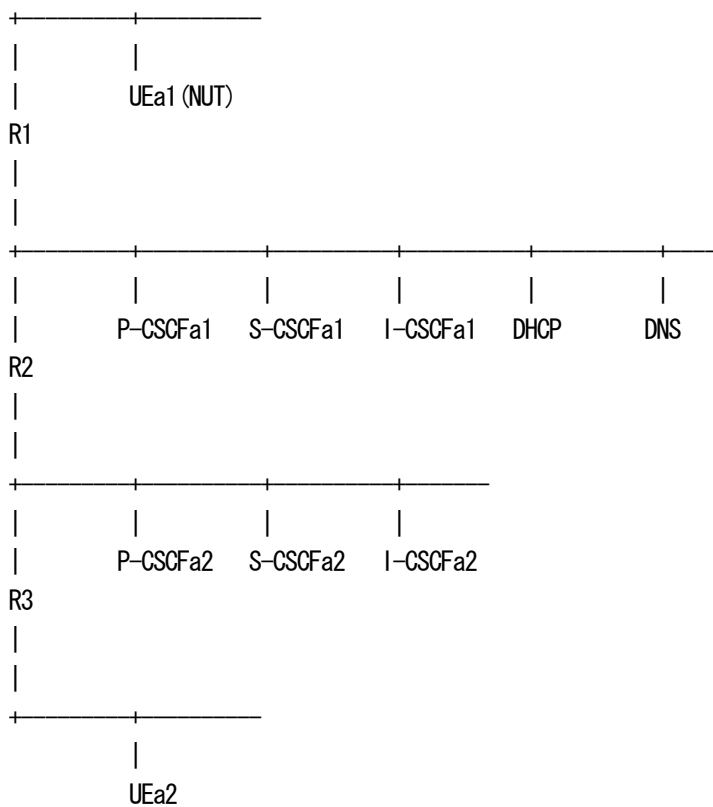

[INITIALIZATION]

UEa1(NUT) must be registered with the tester by executing the scenario "UE-INI-B-1-AKA".
For details of "UE-INI-B-1-AKA", refer to the profile "UE-RG-B-1-AKA".



[PROCEDURE]

Home Network

(NUT)

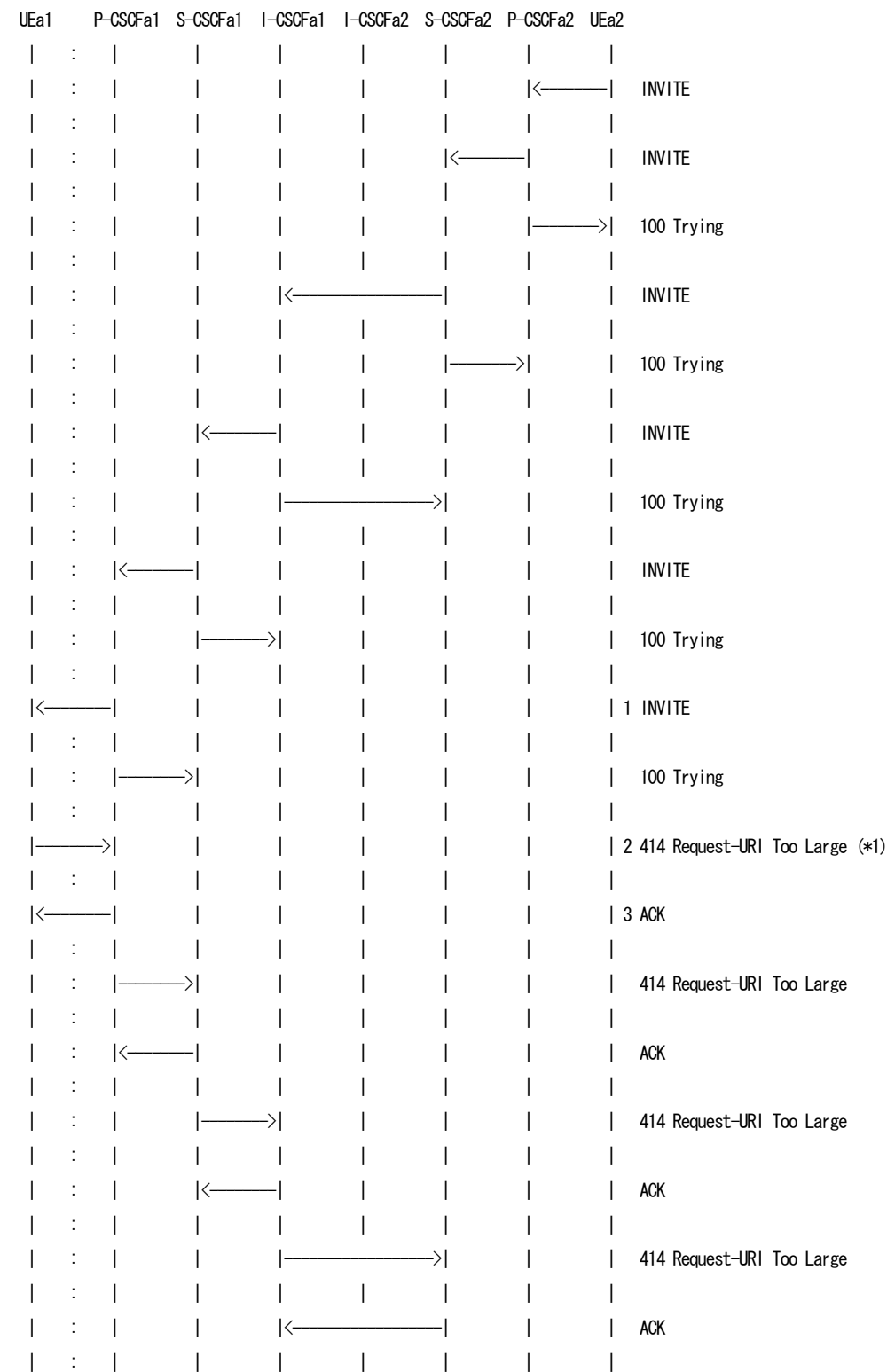



c=IN IP6 nodea2.under.test.com
t=0 0
m=audio 49172 RTP/AVP 0
b=AS:75
a=rtpmap:0 PCMU/8000

2. 414 Request-URI Too Large NUT -> P-CSCF

SIP/2.0 414 Request-URI Too Large

Via: SIP/2.0/UDP p.a1.under.test.com:10001;branch=z9hG4bK431e418c233;
received=3ffe:501:ffff:100::10,SIP/2.0/UDP s.a1.under.test.com;branch=z9hG4bK431e418c4.2;
received=3ffe:501:ffff:100::30,SIP/2.0/UDP i.a1.under.test.com;branch=z9hG4bKnashds418c5a;
received=3ffe:501:ffff:100::20,SIP/2.0/UDP s.a2.under.test.com;branch=z9hG4bK721e418c657u;
received=3ffe:501:ffff:200::30,SIP/2.0/UDP p.a2.under.test.com;branch=z9hG4bKnaghc45ca8;
received=3ffe:501:ffff:200::10,SIP/2.0/UDP [3ffe:501:ffff:2000::1000]:22222;branch=z9hG4bKnashds45ba91
From: <sip:UEa2_public_1@under.test.com>;tag=10fxcde76sl
To: <sip:UEa1_public_1@under.test.com>;tag=414259
Call-ID: 3848276298220188511@under.test.com
CSeq: 1 INVITE
Content-Length: 0

3. ACK P-CSCF -> NUT

ACK sip:UEa1_public_1@node.under.test.com:1357;foo=baaaaa... SIP/2.0
Via: SIP/2.0/UDP p.a1.under.test.com:10001;branch=z9hG4bK431e418c233
Max-Forwards: 65
From: <sip:UEa2_public_1@under.test.com>;tag=10fxcde76sl
To: <sip:UEa1_public_1@under.test.com>;tag=414259
Call-ID: 3848276298220188511@under.test.com
CSeq: 1 ACK
Content-Length: 0

[OBSERVABLE RESULTS]

*1: 2 414 Request-URI Too Larg from NUT to P-CSCF.

See generic_3XX-6XX

- Exception{

* To

If a request contained a To tag in the request, the To header field
in the response MUST equal that of the request.[RFC3261-8.2-41]



The same tag MUST be used for all responses to that request, both final and provisional. [RFC3261-8.2-44])

}

4.6.6 UE-SR-B-6-AKA - Sending 415 response

[NAME]

UE-SR-B-6-AKA - Sending 415 response

[TARGET]

IMS User Equipment (NUT)

[PURPOSE]

To verify that UEa1 sends 415(Unsupported Media Type) response to INVITE request that included Content-Type header with unsupported media type.

[REFERENCE]

TS24.229 A.2.1.4.1

RFC3261 8.2.3

RFC3261 21.4.13

[REQUIREMENT]

NONE

[PARAMETER(NUT)]

public-user-id : sip:UEa1_public_1@under.test.com

private-user-id : UEa1_private@under.test.com

contact_URI : sip:UEa1_public_1@node.under.test.com

HOMENETWORK Domain : sip:under.test.com

[PARAMETER(TESTER)]

public-user-id(UEa2) : sip:UEa2_public_1@under.test.com

P-CSCFa1 : sip:p.a1.under.test.com



[ADDRESS]

UEa1(NUT)	:	3ffe:501:ffff:1000::1000
Router(R1)	:	3ffe:501:ffff:1000::1
P-CSCFa1	:	3ffe:501:ffff:100::10
I-CSCFa1	:	3ffe:501:ffff:100::20
S-CSCFa1	:	3ffe:501:ffff:100::30
DNS	:	3ffe:501:ffff:100::40
DHCP	:	3ffe:501:ffff:100::50
UEa2	:	3ffe:501:ffff:2000::1000
P-CSCFa2	:	3ffe:501:ffff:200::10
I-CSCFa2	:	3ffe:501:ffff:200::20
S-CSCFa2	:	3ffe:501:ffff:200::30

[TOPOLOGY]

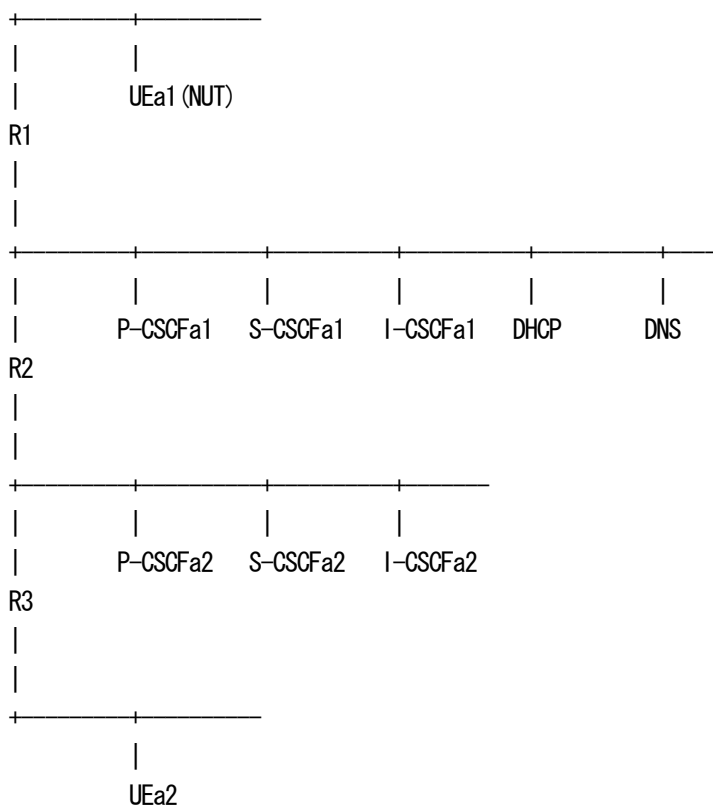

[INITIALIZATION]

UEa1(NUT) must be registered with the tester by executing the scenario "UE-INI-B-1-AKA".
For details of "UE-INI-B-1-AKA", refer to the profile "UE-RG-B-1-AKA".



[PROCEDURE]

Home Network

(NUT)

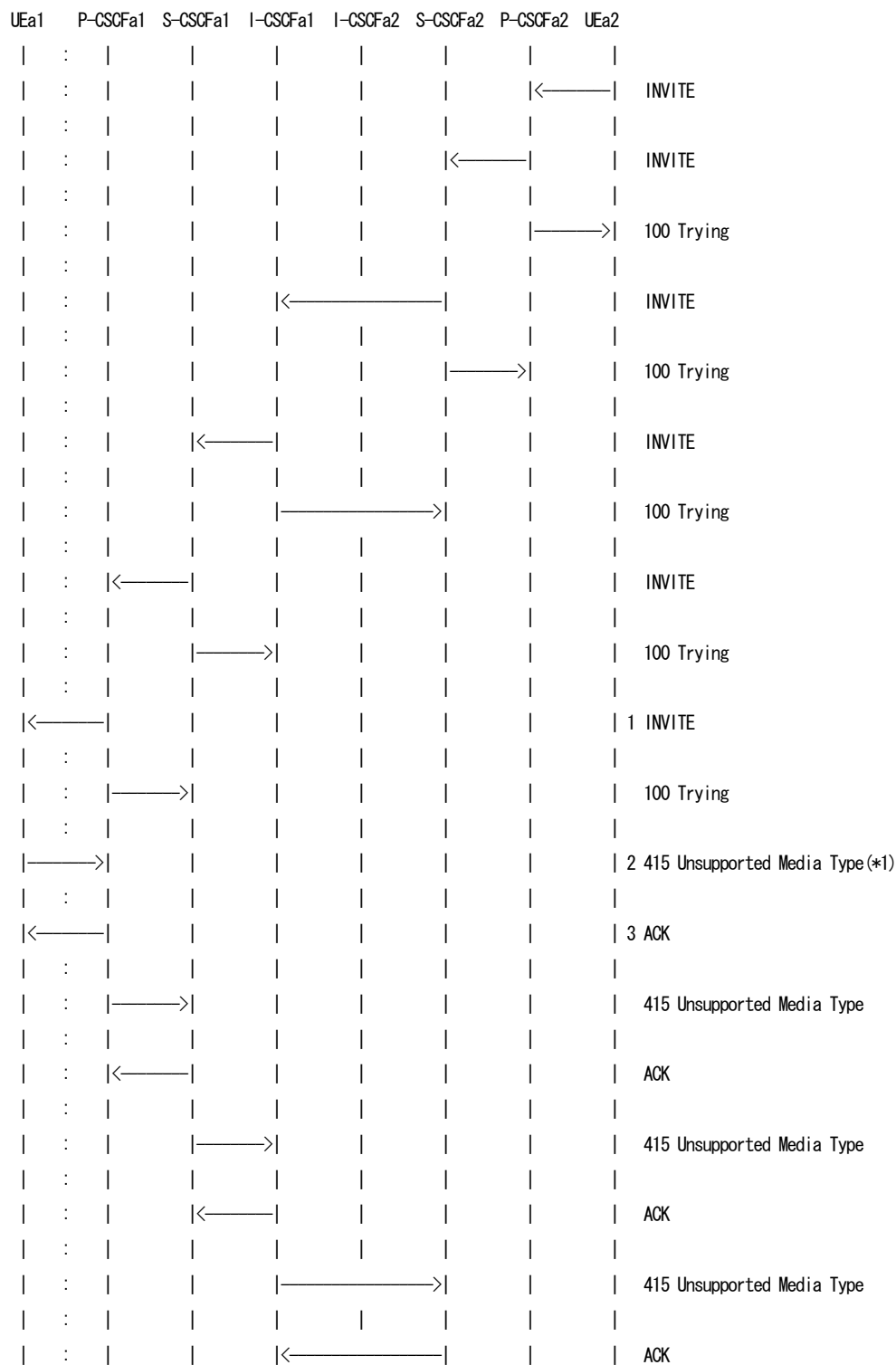



2. 415 Unsupported Media Type NUT -> P-CSCF

SIP/2.0 415 Unsupported Media Type

Via: SIP/2.0/UDP p.a1.under.test.com:10001;branch=z9hG4bK431e418c233;
received=3ffe:501:ffff:100::10,SIP/2.0/UDP s.a1.under.test.com;branch=z9hG4bK431e418c4.2;
received=3ffe:501:ffff:100::30,SIP/2.0/UDP i.a1.under.test.com;branch=z9hG4bKnashds418c5a;
received=3ffe:501:ffff:100::20,SIP/2.0/UDP s.a2.under.test.com;branch=z9hG4bK721e418c657u;
received=3ffe:501:ffff:200::30,SIP/2.0/UDP p.a2.under.test.com;branch=z9hG4bKnaghc45ca8;
received=3ffe:501:ffff:200::10,SIP/2.0/UDP [3ffe:501:ffff:2000::1000]:22222;branch=z9hG4bKnashds45ba91
From: <sjp:UEa2_public_1@under.test.com>;tag=10fxced76sl
To: <sjp:UEa1_public_1@under.test.com>;tag=414259
Call-ID: 3848276298220188511@under.test.com
CSeq: 1 INVITE
Accept: application/sdp
Content-Length: 0

3. ACK P-CSCF -> NUT

ACK sip:UEa1_public_1@node.under.test.com:1357 SIP/2.0

Via: SIP/2.0/UDP p.a1.under.test.com:10001;branch=z9hG4bK431e418c233

Max-Forwards: 65

From: <sjp:UEa2_public_1@under.test.com>;tag=10fxced76sl

To: <sjp:UEa1_public_1@under.test.com>;tag=414259

Call-ID: 3848276298220188511@under.test.com

CSeq: 1 ACK

Content-Length: 0

[OBSERVABLE RESULTS]

*1: 2 415 Unsupported Media Type from NUT to P-CSCF.

See generic_3XX-6XX

- Exception{

* To

If a request contained a To tag in the request, the To header field in the response MUST equal that of the request.[RFC3261-8.2-41]

The same tag MUST be used for all responses to that request, both final and provisional. [RFC3261-8.2-44])

}



- Header Field:

The server **MUST** return a list of acceptable formats using the Accept, Accept-Encoding, or Accept-Language header field, depending on the specific problem with the content.[RFC3261-21.4-8]

* Accept

The response **MUST** contain an Accept header field listing the types of all bodies it understands, in the event the request contained bodies of types not supported by the UAS.[RFC3261-8.2-22]

* Accept-Encoding

If the request contained content encodings not understood by the UAS, the response **MUST** contain an Accept-Encoding header field listing the encodings understood by the UAS.[RFC3261-8.2-23]

* Accept-Language

If the request contained content with languages not understood by the UAS, the response **MUST** contain an Accept-Language header field indicating the languages understood by the UAS.[RFC3261-8.2-24]

4.6.7 UE-SR-B-7-AKA - Sending 416 response

[NAME]

UE-SR-B-7-AKA - Sending 416 response

[TARGET]

IMS User Equipment (NUT)

[PURPOSE]

To verify that UEa1 sends 416 (Unsupported URI Scheme) response to INVITE that has illegal scheme in Request-URI.

[REFERENCE]

TS24.229 A.2.1.4.1

RFC3261 8.2.2.1

[REQUIREMENT]

NONE



[PARAMETER(NUT)]

public-user-id : sip:UEa1_public_1@under.test.com
private-user-id : UEa1_private@under.test.com
contact_URI : sip:UEa1_public_1@node.under.test.com
HOMENETWORK Domain : sip:under.test.com

[PARAMETER(TESTER)]

public-user-id(UEa2) : sip:UEa2_public_1@under.test.com
P-CSCFa1 : sip:p.a1.under.test.com

[ADDRESS]

UEa1(NUT) : 3ffe:501:ffff:1000::1000
Router(R1) : 3ffe:501:ffff:1000::1
P-CSCFa1 : 3ffe:501:fff:100::10
I-CSCFa1 : 3ffe:501:fff:100::20
S-CSCFa1 : 3ffe:501:fff:100::30
DNS : 3ffe:501:fff:100::40
DHCP : 3ffe:501:fff:100::50

UEa2 : 3ffe:501:fff:2000::1000
P-CSCFa2 : 3ffe:501:fff:200::10
I-CSCFa2 : 3ffe:501:fff:200::20
S-CSCFa2 : 3ffe:501:fff:200::30

[TOPOLOGY]

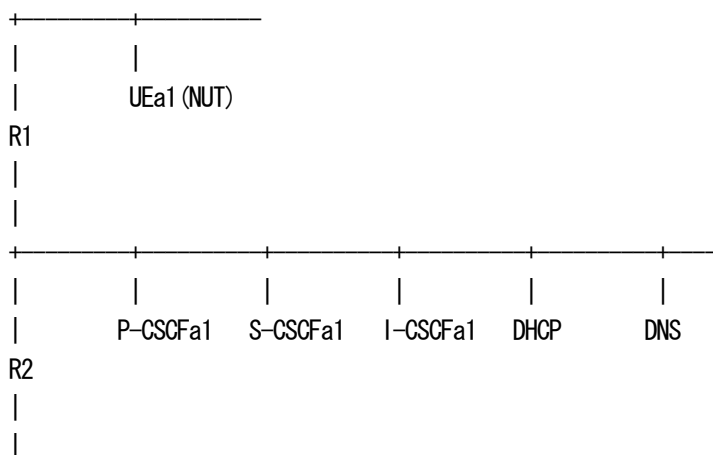

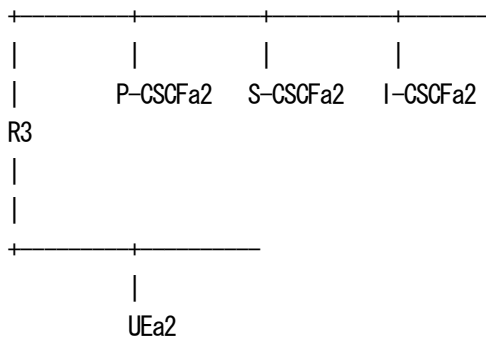

[INITIALIZATION]

UEa1(NUT) must be registered with the tester by executing the scenario "UE-INI-B-1-AKA".

For details of "UE-INI-B-1-AKA", refer to the profile "UE-RG-B-1-AKA".

[PROCEDURE]

Home Network

(NUT)

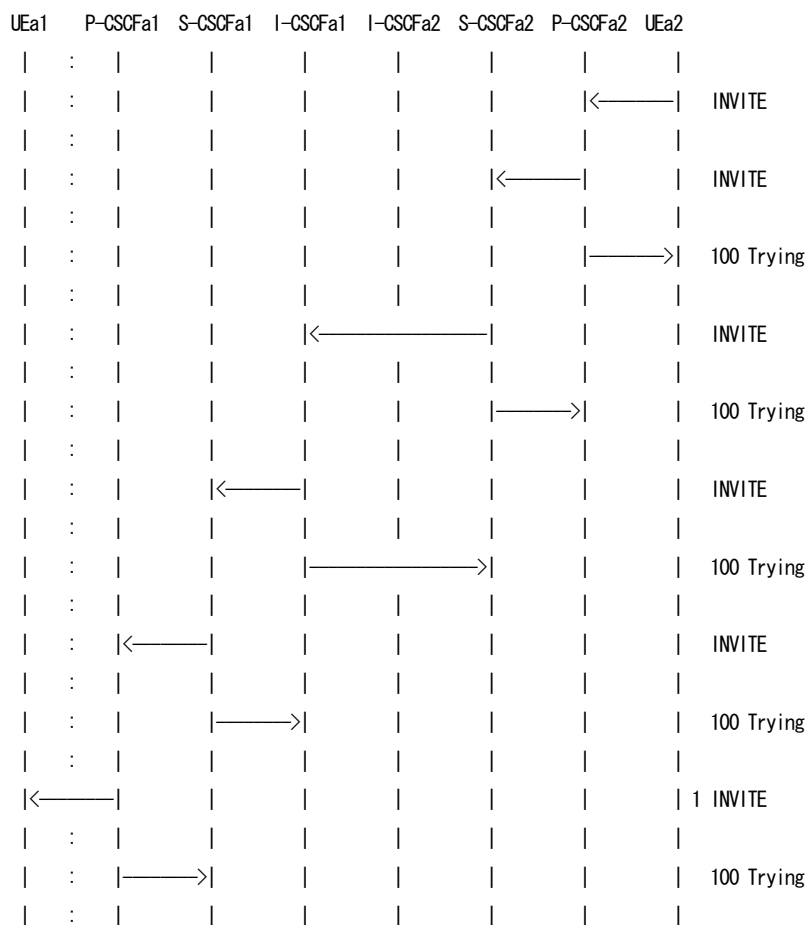



To: <sip:UEa1_public_1@under.test.com>
Call-ID: 3848276298220188511@under.test.com
CSeq: 1 INVITE
Contact: <sip:UEa2_public_1@nodea2.under.test.com:22222>
Supported:
Allow: INVITE,ACK,CANCEL,OPTIONS,BYE
Allow-Events: reg
Accept: application/sdp,application/3gpp-ims+xml
P-Called-Party-ID: <sip:UEa1_public_1@under.test.com>
Content-Type: application/sdp
Content-Length: 154

v=0
o=UEa2 2890844526 2890844526 IN IP6 nodea2.under.test.com
s=-
c=IN IP6 nodea2.under.test.com
t=0 0
m=audio 49172 RTP/AVP 0
b=AS:75
a=rtpmap:0 PCMU/8000

2. 416 Unsupported URI Scheme NUT -> P-CSCF

SIP/2.0 416 Unsupported URI Scheme
Via: SIP/2.0/UDP p.a1.under.test.com:10001;branch=z9hG4bK431e418c233;
received=3ffe:501:ffff:100::10,SIP/2.0/UDP s.a1.under.test.com;branch=z9hG4bK431e418c4.2;
received=3ffe:501:ffff:100::30,SIP/2.0/UDP i.a1.under.test.com;branch=z9hG4bKnashds418c5a;
received=3ffe:501:ffff:100::20,SIP/2.0/UDP s.a2.under.test.com;branch=z9hG4bK721e418c657u;
received=3ffe:501:ffff:200::30,SIP/2.0/UDP p.a2.under.test.com;branch=z9hG4bKnaghc45ca8;
received=3ffe:501:ffff:200::10,SIP/2.0/UDP [3ffe:501:ffff:2000::1000]:22222;branch=z9hG4bKnashds45ba91
From: <sip:UEa2_public_1@under.test.com>;tag=10fxced76sl
To: <sip:UEa1_public_1@under.test.com>;tag=414259
Call-ID: 3848276298220188511@under.test.com
CSeq: 1 INVITE
Content-Length: 0

3. ACK P-CSCF -> NUT

ACK foo:UEa1_public_1@node.under.test.com:1357 SIP/2.0
Via: SIP/2.0/UDP p.a1.under.test.com:10001;branch=z9hG4bK431e418c233
Max-Forwards: 65
From: <sip:UEa2_public_1@under.test.com>;tag=10fxced76sl
To: <sip:UEa1_public_1@under.test.com>;tag=414259



Call-ID: 3848276298220188511 @under.test.com

CSeq: 1 ACK

Content-Length: 0

[OBSERVABLE RESULTS]

*1: 2 416 Unsupported URI Scheme from NUT to P-CSCF.

See generic_3XX-6XX

- Exception{

* To

If a request contained a To tag in the request, the To header field in the response MUST equal that of the request.[RFC3261-8.2-41]

The same tag MUST be used for all responses to that request, both final and provisional. [RFC3261-8.2-44])

}

4.6.8 UE-SR-B-8-AKA - Sending 420 response

[NAME]

UE-SR-B-8-AKA - Sending 420 response.

[TARGET]

IMS User Equipment (NUT)

[PURPOSE]

To verify that UEa1 sends 420(Bad Extension) response to INVITE request that included Require header with wrong value.

[REFERENCE]

TS24.229 A.2.1.4.1

RFC3261 8.2.2.3

RFC3261 21.4.15

[REQUIREMENT]



NONE

[PARAMETER(NUT)]

public-user-id : sip:UEa1_public_1@under.test.com
private-user-id : UEa1_private@under.test.com
contact_URI : sip:UEa1_public_1@node.under.test.com
HOMENETWORK Domain : sip:under.test.com

[PARAMETER(TESTER)]

public-user-id(UEa2) : sip:UEa2_public_1@under.test.com
P-CSCFa1 : sip:p.a1.under.test.com

[ADDRESS]

UEa1(NUT) : 3ffe:501:fff:1000::1000
Router(R1) : 3ffe:501:fff:1000::1
P-CSCFa1 : 3ffe:501:fff:100::10
I-CSCFa1 : 3ffe:501:fff:100::20
S-CSCFa1 : 3ffe:501:fff:100::30
DNS : 3ffe:501:fff:100::40
DHCP : 3ffe:501:fff:100::50

UEa2 : 3ffe:501:fff:2000::1000
P-CSCFa2 : 3ffe:501:fff:200::10
I-CSCFa2 : 3ffe:501:fff:200::20
S-CSCFa2 : 3ffe:501:fff:200::30

[TOPOLOGY]

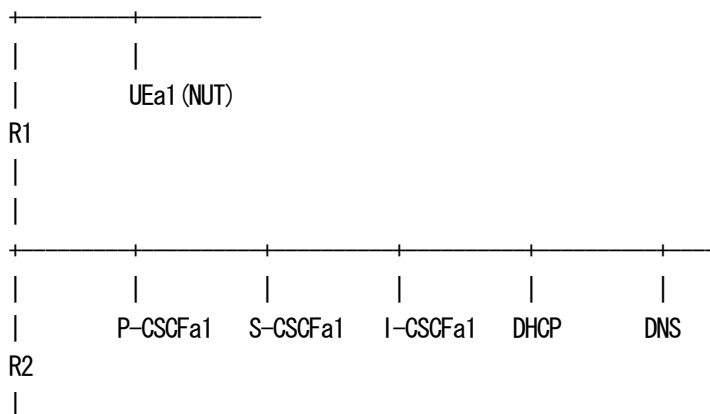

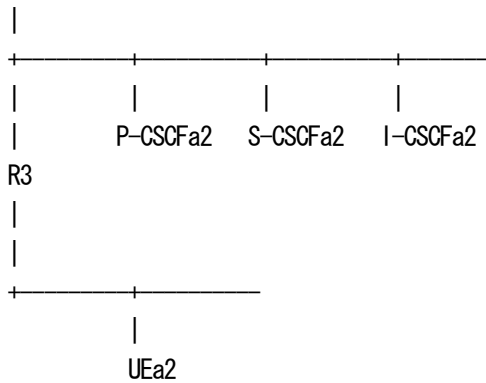

[INITIALIZATION]

UEa1(NUT) must be registered with the tester by executing the scenario "UE-INI-B-1-AKA".
For details of "UE-INI-B-1-AKA", refer to the profile "UE-RG-B-1-AKA".

[PROCEDURE]

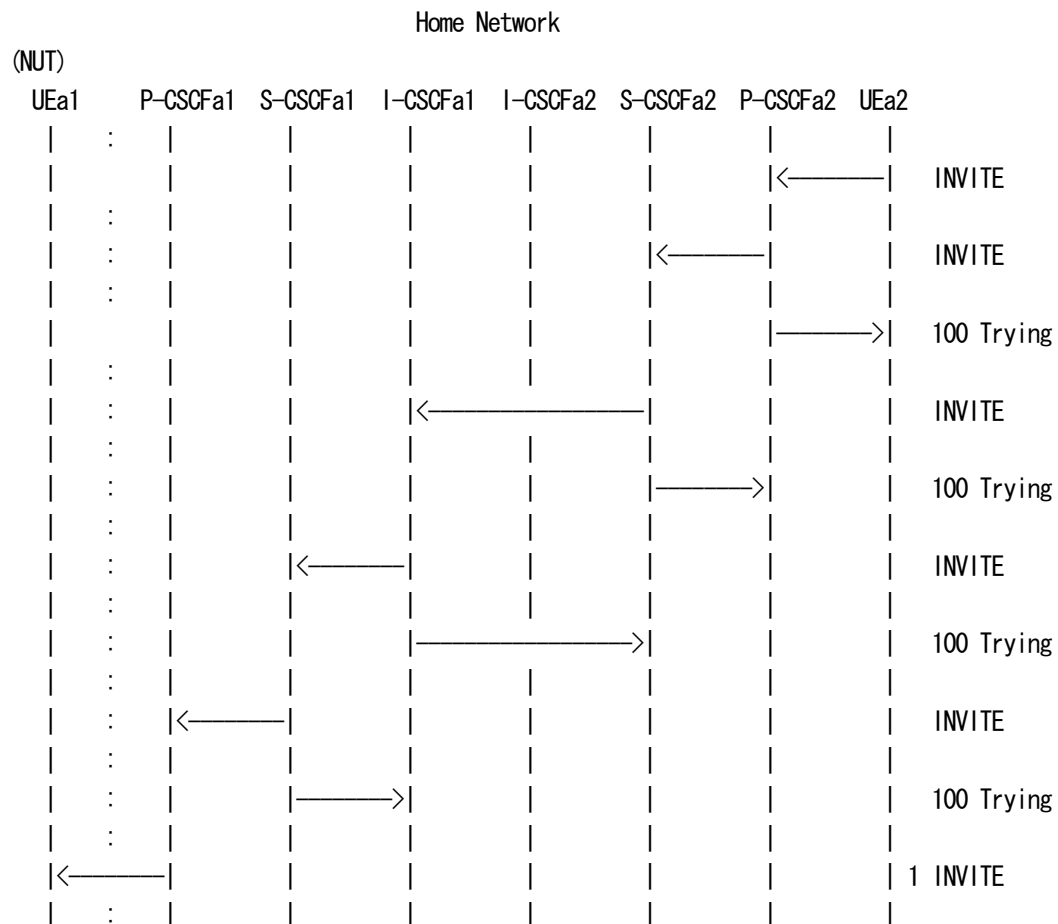

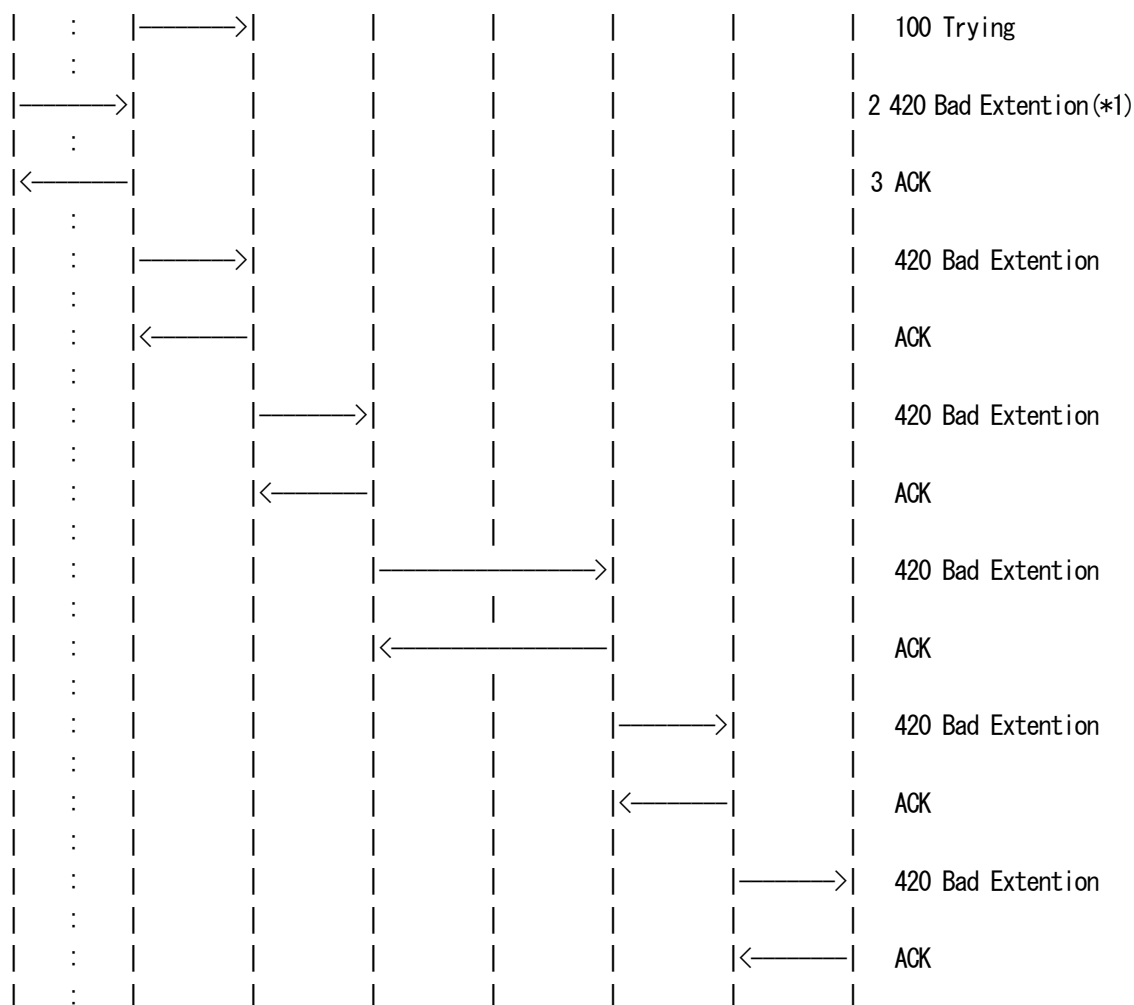

- 1 NUT receives INVITE.
- 2 NUT sends 420 Bad Extension.
- 3 NUT receives ACK.

=== Message example ===

1. INVITE P-CSCF -> NUT

```
INVITE sip:UEa1_public_1@node.under.test.com:1357 SIP/2.0
Via: SIP/2.0/UDP p.a1.under.test.com:10001;branch=z9hG4bK431e418c233,
SIP/2.0/UDP s.a1.under.test.com;branch=z9hG4bK431e418c4.2;received=3ffe:501:ffff:100::30,
SIP/2.0/UDP i.a1.under.test.com;branch=z9hG4bKnashds418c5a;received=3ffe:501:ffff:100::20,
SIP/2.0/UDP s.a2.under.test.com;branch=z9hG4bK721e418c657u;received=3ffe:501:ffff:200::30,
SIP/2.0/UDP p.a2.under.test.com;branch=z9hG4bKnaghc45ca8;received=3ffe:501:ffff:200::10,
SIP/2.0/UDP [3ffe:501:ffff:2000::1000]:22222;branch=z9hG4bKnashds45ba91
Record-Route: <sip:p.a1.under.test.com:10001;lr>,<sip:s.a1.under.test.com;lr>
```



<sip:s.a2.under.test.com;lr>,<sip:p.a2.under.test.com;lr>
Max-Forwards: 65
From: <sip:UEa2_public_1@under.test.com>;tag=10fxced76sl
To: <sip:UEa1_public_1@under.test.com>
Call-ID: 3848276298220188511@under.test.com
CSeq: 1 INVITE
Contact: <sip:UEa2_public_1@nodea2.under.test.com:22222>
Require: foo
Supported:
Allow: INVITE,ACK,CANCEL,OPTIONS,BYE
Allow-Events: reg
Accept: application/sdp,application/3gpp-ims+xml
P-Called-Party-ID: <sip:UEa1_public_1@under.test.com>
Content-Type: application/sdp
Content-Length: 154

v=0
o=UEa2 2890844526 2890844526 IN IP6 nodea2.under.test.com
s=-
c=IN IP6 nodea2.under.test.com
t=0 0
m=audio 49172 RTP/AVP 0
b=AS:75
a=rtpmap:0 PCMU/8000

2. 420 Bad Extention NUT -> P-CSCF

SIP/2.0 420 Bad Extention

Via: SIP/2.0/UDP p.a1.under.test.com:10001;branch=z9hG4bK431e418c233;
received=3ffe:501:ffff:100::10,SIP/2.0/UDP s.a1.under.test.com;branch=z9hG4bK431e418c4.2;
received=3ffe:501:ffff:100::30,SIP/2.0/UDP i.a1.under.test.com;branch=z9hG4bKnashds418c5a;
received=3ffe:501:ffff:100::20,SIP/2.0/UDP s.a2.under.test.com;branch=z9hG4bK721e418c657u;
received=3ffe:501:ffff:200::30,SIP/2.0/UDP p.a2.under.test.com;branch=z9hG4bKnaghc45ca8;
received=3ffe:501:ffff:200::10,SIP/2.0/UDP [3ffe:501:ffff:2000::1000]:22222;branch=z9hG4bKnashds45ba91
From: <sip:UEa2_public_1@under.test.com>;tag=10fxced76sl
To: <sip:UEa1_public_1@under.test.com>;tag=414259
Call-ID: 3848276298220188511@under.test.com
CSeq: 1 INVITE
Unsupported: foo
Content-Length: 0

3. ACK P-CSCF -> NUT



ACK sip:UEa1_public_1@node.under.test.com:1357 SIP/2.0
Via: SIP/2.0/UDP p.a1.under.test.com:10001;branch=z9hG4bK431e418c233
Max-Forwards: 65
From: <sip:UEa2_public_1@under.test.com>;tag=10fxced76sl
To: <sip:UEa1_public_1@under.test.com>;tag=414259
Call-ID: 3848276298220188511@under.test.com
CSeq: 1 ACK
Content-Length: 0

[OBSERVABLE RESULTS]

*1: 2 420 Bad Extension from NUT to P-CSCF.

See generic_3XX-6XX

- Exception{

* To

If a request contained a To tag in the request, the To header field in the response MUST equal that of the request.[RFC3261-8.2-41]

The same tag MUST be used for all responses to that request, both final and provisional. [RFC3261-8.2-44])

}

- Header Field:

* Unsupported

The server MUST include a list of the unsupported extensions in an Unsupported header field in the response.[RFC3261-21.4-9]

The UAS MUST add an Unsupported header field, and list in it those options it does not understand amongst those in the Require header field of the request.[RFC3261-8.2-17]

4.6.9 UE-SR-B-9-AKA - Sending 480/486 response

[NAME]

UE-SR-B-9-AKA - Sending 480/486 response.

[TARGET]

IMS User Equipment (NUT)



[PURPOSE]

To verify that the UEa1 sends 480 (Temporarily Unavailable) / 486 (Busy Here) to INVITE when UEa1 is busy.

[REFERENCE]

TS24.229 A.2.1.4.1
RFC3261 13.3.1.3
RFC3261 21.4.18
RFC3261 21.4.24

[REQUIREMENT]

NONE

[PARAMETER(NUT)]

public-user-id : sip:UEa1_public_1@under.test.com
private-user-id : UEa1_private@under.test.com
contact_URI : sip:UEa1_public_1@node.under.test.com
HOMENETWORK Domain : sip:under.test.com

[PARAMETER(TESTER)]

public-user-id(UEa2) : sip:UEa2_public_1@under.test.com
P-CSCFa1 : sip:p.a1.under.test.com

[ADDRESS]

UEa1(NUT) : 3ffe:501:fff:1000::1000
Router(R1) : 3ffe:501:fff:1000::1
P-CSCFa1 : 3ffe:501:fff:100::10
I-CSCFa1 : 3ffe:501:fff:100::20
S-CSCFa1 : 3ffe:501:fff:100::30
DNS : 3ffe:501:fff:100::40
DHCP : 3ffe:501:fff:100::50

UEa2 : 3ffe:501:fff:2000::1000
P-CSCFa2 : 3ffe:501:fff:200::10
I-CSCFa2 : 3ffe:501:fff:200::20
S-CSCFa2 : 3ffe:501:fff:200::30

[TOPOLOGY]

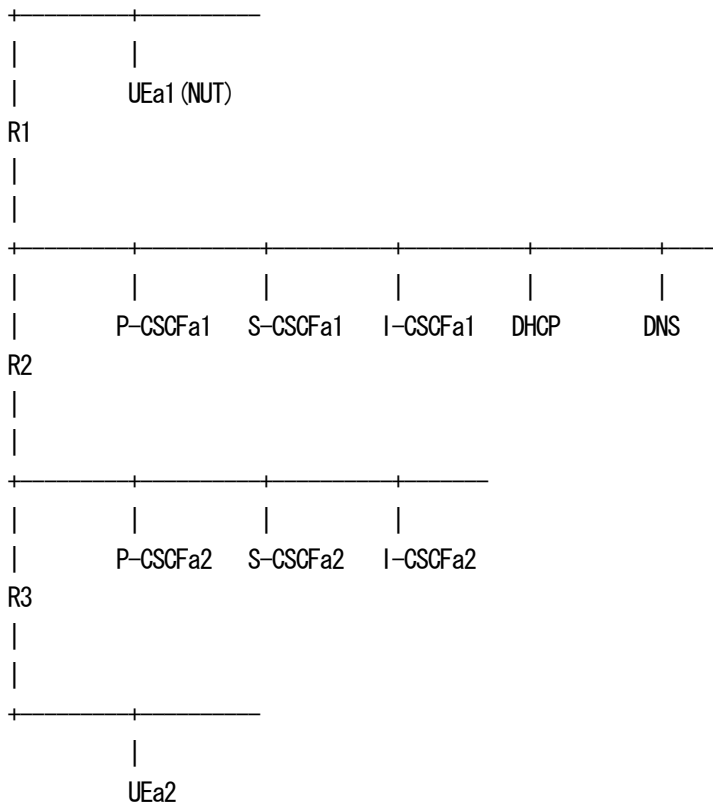

[INITIALIZATION]

UEa1(NUT) must be registered with the tester by executing the scenario "UE-INI-B-1-AKA".
 For details of "UE-INI-B-1-AKA", refer to the profile "UE-RG-B-1-AKA".

[PROCEDURE]

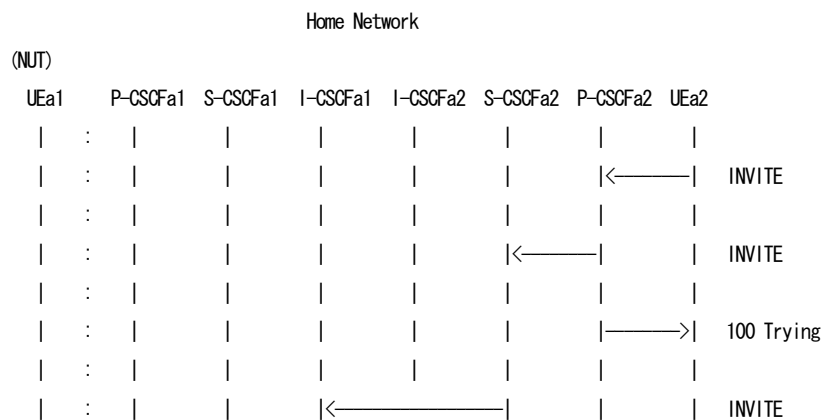

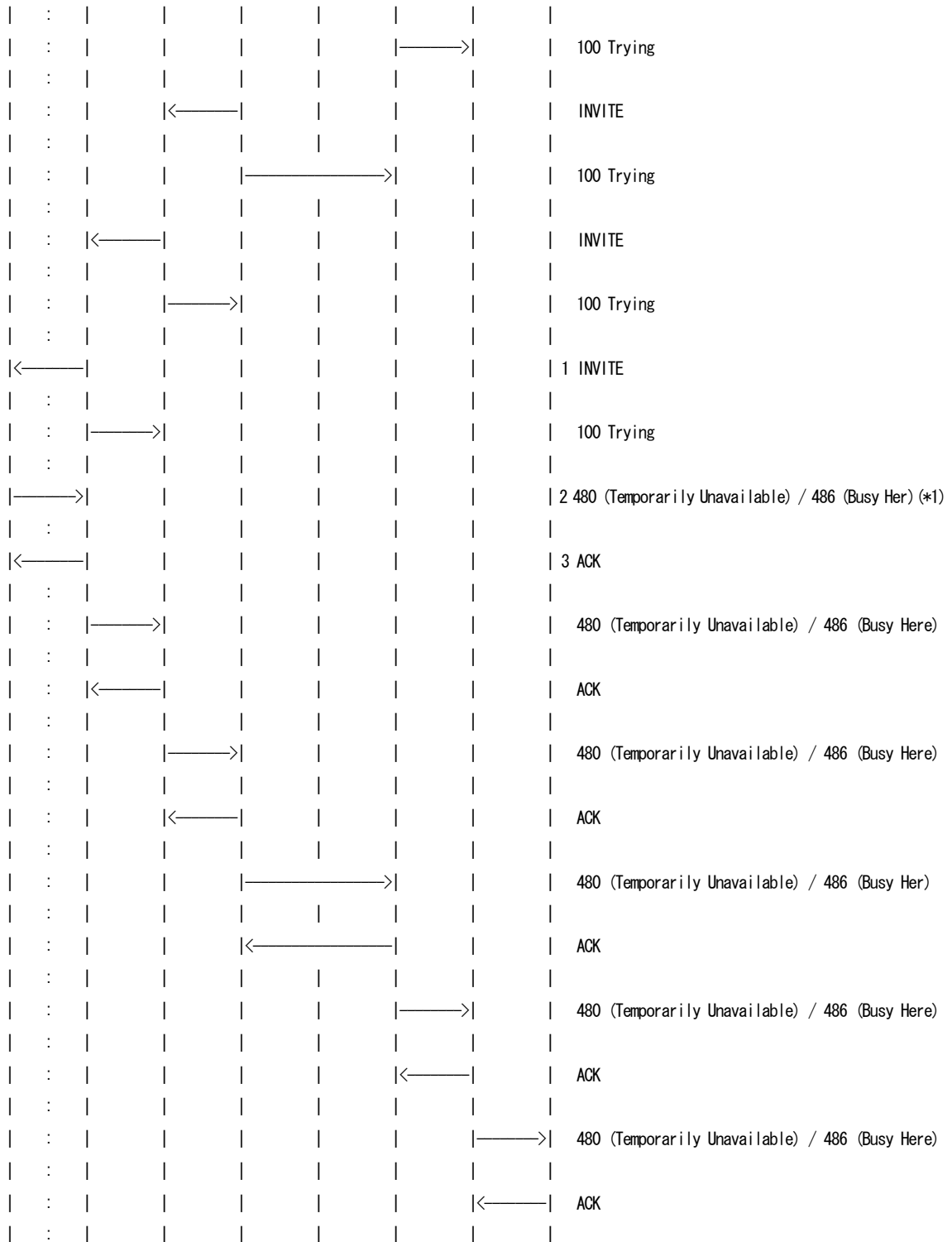

- 1 NUT receives INVITE.
- 2 NUT sends 480 Temporarily Unavailable / 486 Busy Here.
- 3 NUT receives ACK.



=== Message example ===

1. INVITE P-CSCF -> NUT

INVITE sip:UEa1_public_1@node.under.test.com:1357 SIP/2.0
Via: SIP/2.0/UDP p.a1.under.test.com:10001;branch=z9hG4bK431e418c233,
SIP/2.0/UDP s.a1.under.test.com;branch=z9hG4bK431e418c4.2;received=3ffe:501:ffff:100::30,
SIP/2.0/UDP i.a1.under.test.com;branch=z9hG4bKnashds418c5a;received=3ffe:501:ffff:100::20,
SIP/2.0/UDP s.a2.under.test.com;branch=z9hG4bK721e418c657u;received=3ffe:501:ffff:200::30,
SIP/2.0/UDP p.a2.under.test.com;branch=z9hG4bKnaghc45ca8;received=3ffe:501:ffff:200::10,
SIP/2.0/UDP [3ffe:501:ffff:2000::1000]:22222;branch=z9hG4bKnashds45ba91
Record-Route: <sip:p.a1.under.test.com:10001;lr>,<sip:s.a1.under.test.com;lr>,
<sip:s.a2.under.test.com;lr>,<sip:p.a2.under.test.com;lr>
Max-Forwards: 65
From: <sip:UEa2_public_1@under.test.com>;tag=10fxced76sl
To: <sip:UEa1_public_1@under.test.com>
Call-ID: 3848276298220188511@under.test.com
CSeq: 1 INVITE
Contact: <sip:UEa2_public_1@nodea2.under.test.com:22222>
Supported:
Allow: INVITE,ACK,CANCEL,OPTIONS,BYE
Allow-Events: reg
Accept: application/sdp,application/3gpp-ims+xml
P-Called-Party-ID: <sip:UEa1_public_1@under.test.com>
Content-Type: application/sdp
Content-Length: 154

v=0
o=UEa2 2890844526 2890844526 IN IP6 nodea2.under.test.com
s=-
c=IN IP6 nodea2.under.test.com
t=0 0
m=audio 49172 RTP/AVP 0
b=AS:75
a=rtpmap:0 PCMU/8000

2. 486 Busy Here NUT -> P-CSCF

SIP/2.0 486 Busy Here
Via: SIP/2.0/UDP
p.a1.under.test.com:10001;branch=z9hG4bK431e418c233;received=3ffe:501:ffff:100::10,SIP/2.0/UDP
s.a1.under.test.com;branch=z9hG4bK431e418c4.2;received=3ffe:501:ffff:100::30,SIP/2.0/UDP



i.a1.under.test.com;branch=z9hG4bKnashds418c5a;received=3ffe:501:ffff:100::20,SIP/2.0/UDP
s.a2.under.test.com;branch=z9hG4bK721e418c657u;received=3ffe:501:ffff:200::30,SIP/2.0/UDP
p.a2.under.test.com;branch=z9hG4bKnaghc45ca8;received=3ffe:501:ffff:200::10,SIP/2.0/UDP
[3ffe:501:ffff:2000::1000];22222;branch=z9hG4bKnashds45ba91
From: <sip:UEa2_public_1@under.test.com>;tag=10fxcde76sl
To: <sip:UEa1_public_1@under.test.com>;tag=414259
Call-ID: 3848276298220188511@under.test.com
CSeq: 1 INVITE
Content-Length: 0

3. ACK P-CSCF -> NUT

ACK sip:UEa1_public_1@node.under.test.com:1357 SIP/2.0
Via: SIP/2.0/UDP p.a1.under.test.com:10001;branch=z9hG4bK431e418c233
Max-Forwards: 65
From: <sip:UEa2_public_1@under.test.com>;tag=10fxcde76sl
To: <sip:UEa1_public_1@under.test.com>;tag=414259
Call-ID: 3848276298220188511@under.test.com
CSeq: 1 ACK
Content-Length: 0

[OBSERVABLE RESULTS]

*1: 2 480 Temporarily Unavailable/486 Busy Here from NUT to P-CSCF.

See generic_3XX-6XX

- Exception{

* To

If a request contained a To tag in the request, the To header field in the response MUST equal that of the request.[RFC3261-8.2-41]

The same tag MUST be used for all responses to that request, both final and provisional. [RFC3261-8.2-44])

}

4.6.10 UE-SR-B-10-AKA - Sending 482 response

[NAME]

UE-SR-B-10-AKA - Sending 482 response.



[TARGET]

IMS User Equipment (NUT)

[PURPOSE]

To verify that the UEa1 sends 482(Loop Detected) response when the UEa1 detected loop.

[REFERENCE]

TS24.229 A.2.1.4.1

RFC3261 8.2.2.2

[REQUIREMENT]

NONE

[PARAMETER(NUT)]

public-user-id : sip:UEa1_public_1@under.test.com
private-user-id : UEa1_private@under.test.com
contact_URI : sip:UEa1_public_1@node.under.test.com
HOMENETWORK Domain : sip:under.test.com

[PARAMETER(TESTER)]

public-user-id(UEa2) : sip:UEa2_public_1@under.test.com
P-CSCFa1 : sip:p.a1.under.test.com

[ADDRESS]

UEa1(NUT) : 3ffe:501:fff:1000::1000
Router(R1) : 3ffe:501:fff:1000::1
P-CSCFa1 : 3ffe:501:fff:100::10
I-CSCFa1 : 3ffe:501:fff:100::20
S-CSCFa1 : 3ffe:501:fff:100::30
DNS : 3ffe:501:fff:100::40
DHCP : 3ffe:501:fff:100::50

UEa2 : 3ffe:501:fff:2000::1000
P-CSCFa2 : 3ffe:501:fff:200::10
I-CSCFa2 : 3ffe:501:fff:200::20
S-CSCFa2 : 3ffe:501:fff:200::30

[TOPOLOGY]

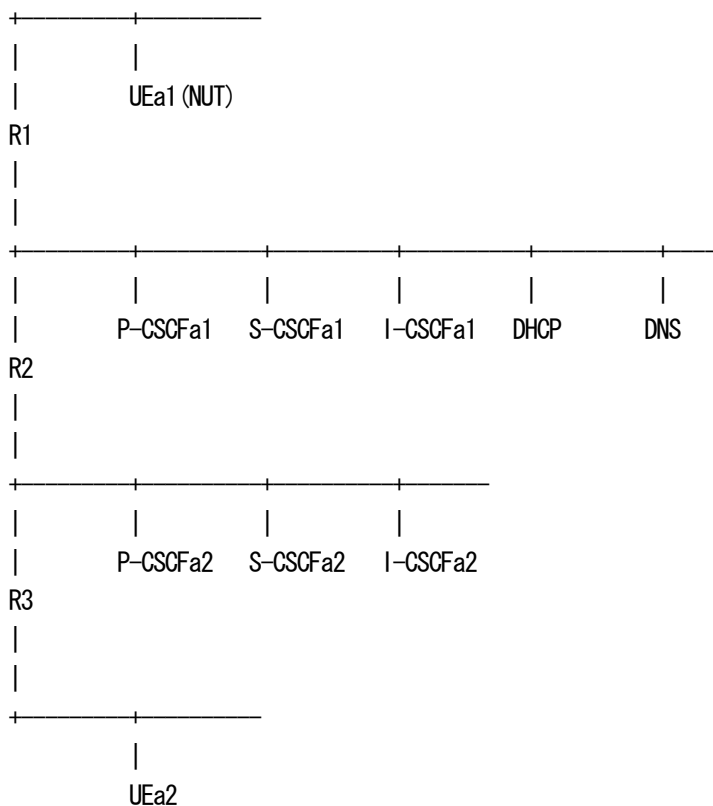

[INITIALIZATION]

UEa1(NUT) must be registered with the tester by executing the scenario "UE-INI-B-1-AKA". For details of "UE-INI-B-1-AKA", refer to the profile "UE-RG-B-1-AKA".

[PROCEDURE]

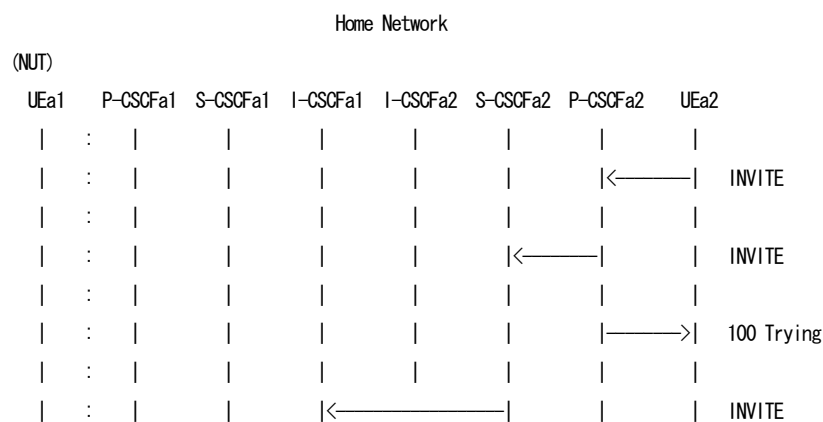

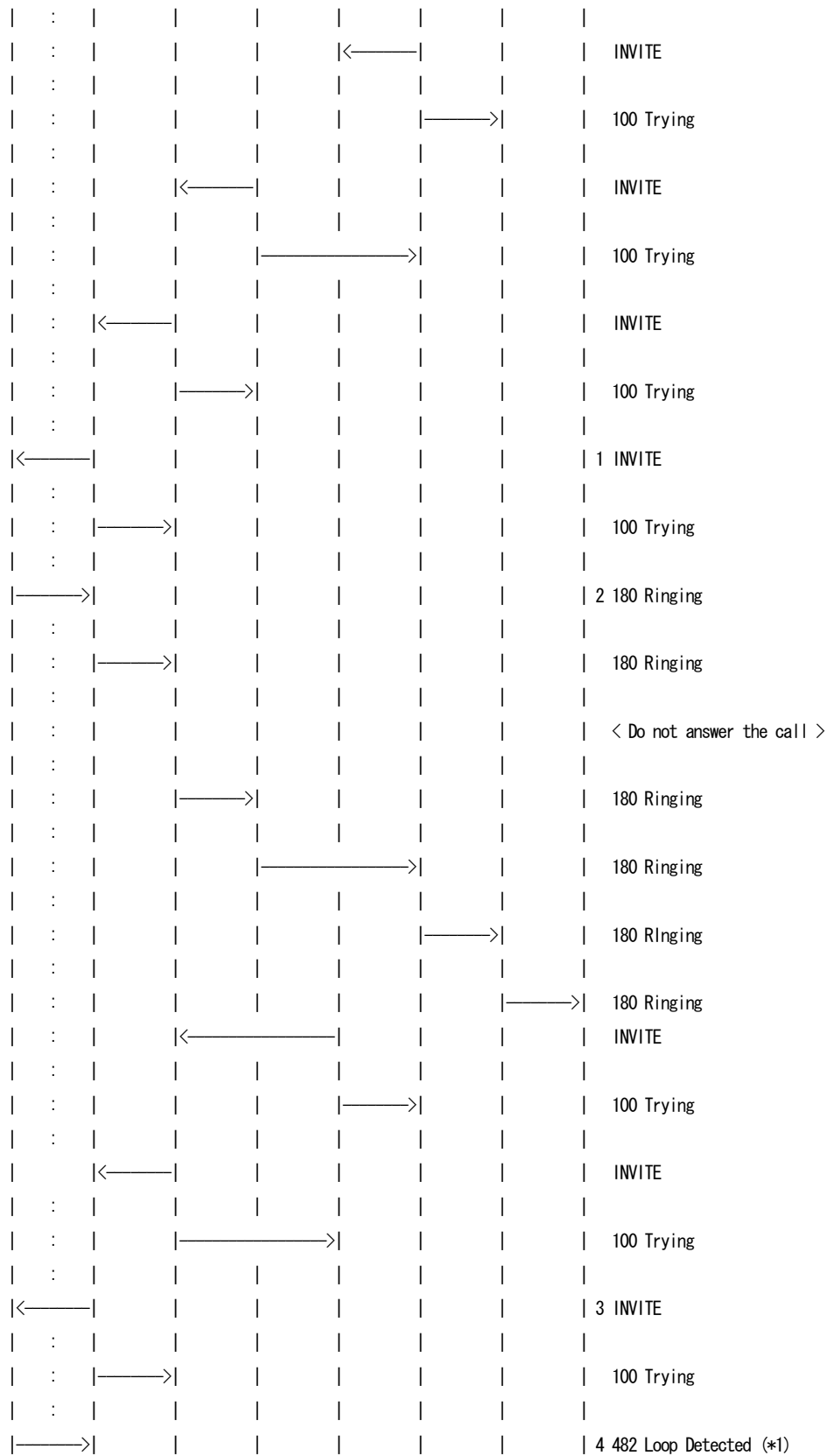

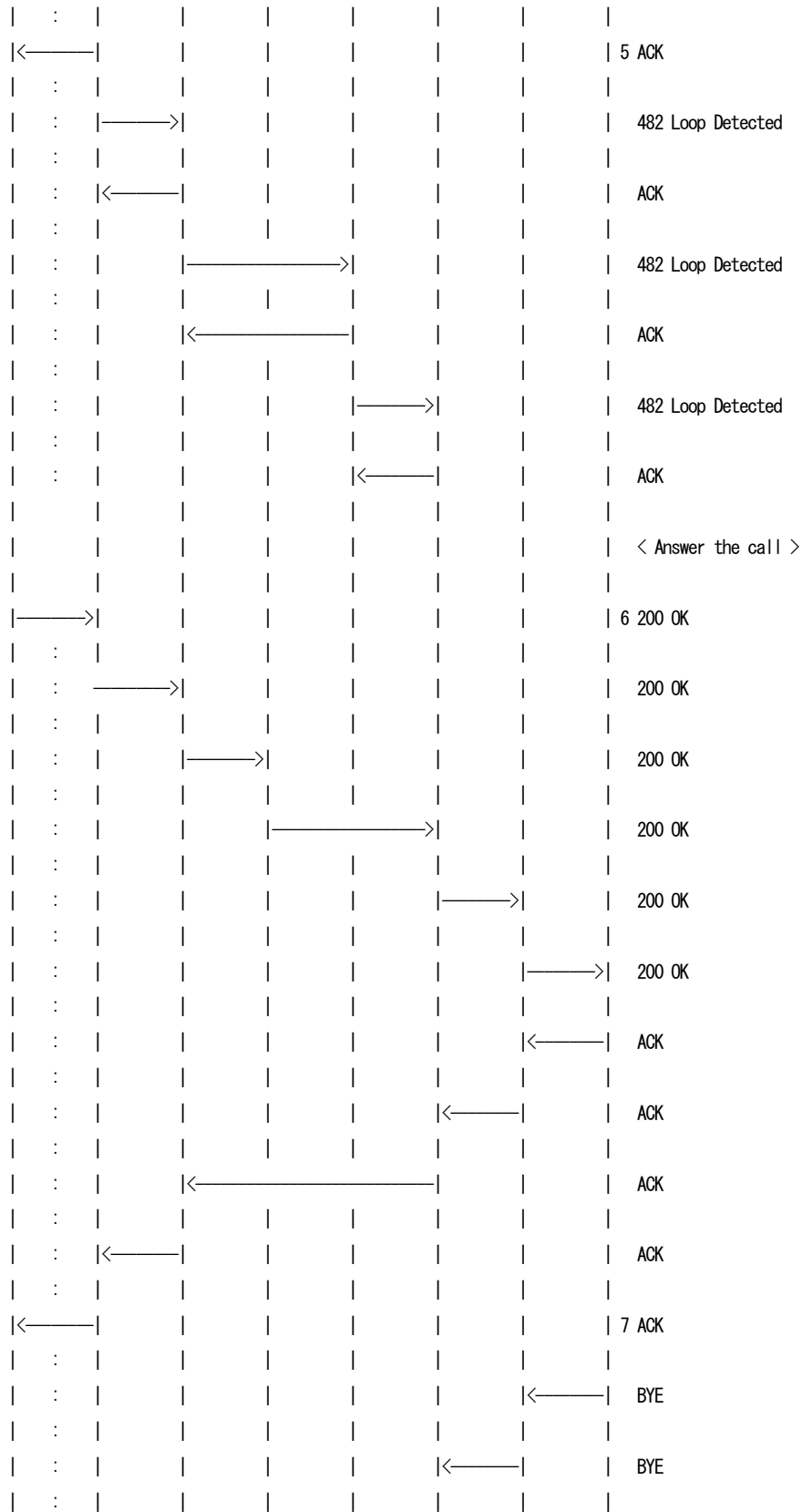



```

|   :   |           |←──────────────────────────────────|           |           |   BYE
|   :   |           |           |           |           |           |           |
|   :   |←──────────|           |           |           |           |           |   BYE
|   :   |           |           |           |           |           |           |
|←──────────|           |           |           |           |           |           | 8 BYE
|   :   |           |           |           |           |           |           |
|──────────>|           |           |           |           |           |           | 9 200 OK
|   :   |           |           |           |           |           |           |
|   :   |──────────>|           |           |           |           |           |           | 200 OK
|   :   |           |           |           |           |           |           |
|   :   |           |──────────────────────────────────>|           |           |           | 200 OK
|   :   |           |           |           |           |           |           |           |
|   :   |           |           |           |           |──────────>|           |           |           | 200 OK
|   :   |           |           |           |           |           |           |           |
|   :   |           |           |           |           |           |──────────>|           |           |           | 200 OK
|   :   |           |           |           |           |           |           |           |

```

- 1 NUT receives INVITE
- 2 NUT sends 180 Ringing
- 3 NUT receives INVITE(from different path)
- 4 NUT sends 482 Loop Detected
- 5 NUT receives ACK
- 6 NUT sends 200 OK
- 7 NUT receives ACK
- 8 NUT receives BYE
- 9 NUT sends 200 OK

=== Message example ===

1. INVITE P-CSCF -> NUT

```

INVITE sip:UEa1_public_1@node.under.test.com:1357 SIP/2.0
Via: SIP/2.0/UDP p.a1.under.test.com:10001;branch=z9hG4bK431e418c233,
SIP/2.0/UDP s.a1.under.test.com;branch=z9hG4bK431e418c4.2;received=3ffe:501:ffff:100::30,
SIP/2.0/UDP i.a1.under.test.com;branch=z9hG4bKnashds418c5a;received=3ffe:501:ffff:100::20,
SIP/2.0/UDP s.a2.under.test.com;branch=z9hG4bK721e418c657u;received=3ffe:501:ffff:200::30,
SIP/2.0/UDP p.a2.under.test.com;branch=z9hG4bKnaghc45ca8;received=3ffe:501:ffff:200::10,
SIP/2.0/UDP [3ffe:501:ffff:2000::1000]:22222;branch=z9hG4bKnashds45ba91
Record-Route: <sip:p.a1.under.test.com:10001;lr>,<sip:s.a1.under.test.com;lr>,<
sip:s.a2.under.test.com;lr>,<sip:p.a2.under.test.com;lr>
Max-Forwards: 65
From: <sip:UEa2_public_1@under.test.com>;tag=10fxced76sl

```



To: <sip:UEa1_public_1@under.test.com>
Call-ID: 3848276298220188511@under.test.com
CSeq: 1 INVITE
Contact: <sip:UEa2_public_1@nodea2.under.test.com:22222>
Supported:
Allow: INVITE,ACK,CANCEL,OPTIONS,BYE
Allow-Events: reg
Accept: application/sdp,application/3gpp-ims+xml
P-Called-Party-ID: <sip:UEa1_public_1@under.test.com>
Content-Type: application/sdp
Content-Length: 154

v=0
o=UEa2 2890844526 2890844526 IN IP6 nodea2.under.test.com
s=
c=IN IP6 nodea2.under.test.com
t=0 0
m=audio 49172 RTP/AVP 0
b=AS:75
a=rtpmap:0 PCMU/8000

2. 180 Ringing NUT -> P-CSCF

SIP/2.0 180 Ringing

Via: SIP/2.0/UDP p.a1.under.test.com:10001;branch=z9hG4bK431e418c233;
received=3ffe:501:ffff:100::10,SIP/2.0/UDP s.a1.under.test.com;branch=z9hG4bK431e418c4.2;
received=3ffe:501:ffff:100::30,SIP/2.0/UDP i.a1.under.test.com;branch=z9hG4bKnashds418c5a;
received=3ffe:501:ffff:100::20,SIP/2.0/UDP s.a2.under.test.com;branch=z9hG4bK721e418c657u;
received=3ffe:501:ffff:200::30,SIP/2.0/UDP p.a2.under.test.com;branch=z9hG4bKnaghc45ca8;
received=3ffe:501:ffff:200::10,SIP/2.0/UDP [3ffe:501:ffff:2000::1000]:22222;branch=z9hG4bKnashds45ba91
From: <sip:UEa2_public_1@under.test.com>;tag=10fxced76sl
To: <sip:UEa1_public_1@under.test.com>;tag=414259
Call-ID: 3848276298220188511@under.test.com
CSeq: 1 INVITE
Content-Length: 0

3. INVITE P-CSCFa1 -> NUT

INVITE sip:UEa1_public_1@node.under.test.com:1357 SIP/2.0

Via: SIP/2.0/UDP p.a1.under.test.com:10001;branch=z9hG4bK431e418c234,
SIP/2.0/UDP s.a1.under.test.com;branch=z9hG4bK431e418c4.3;received=3ffe:501:ffff:100::30,
SIP/2.0/UDP i.a2.under.test.com;branch=z9hG4bKnashds418c5b;received=3ffe:501:ffff:100::20,
SIP/2.0/UDP s.a2.under.test.com;branch=z9hG4bK721e418c657u;received=3ffe:501:ffff:200::30,



SIP/2.0/UDP p.a2.under.test.com;branch=z9hG4bKnaghc45ca8;received=3ffe:501:ffff:200::10,
SIP/2.0/UDP [3ffe:501:ffff:2000::1000]:22222;branch=z9hG4bKnashds45ba91
Record-Route: <sip:p.a1.under.test.com:10001;lr>,<sip:s.a1.under.test.com;lr>,
<sip:s.a2.under.test.com;lr>,<sip:p.a2.under.test.com;lr>
Max-Forwards: 65
From: <sip:UEa2_public_1@under.test.com>;tag=10fxced76sl
To: <sip:UEa1_public_1@under.test.com>
Call-ID: 3848276298220188511@under.test.com
CSeq: 1 INVITE
Contact: <sip:UEa2_public_1@nodea2.under.test.com:22222>
Supported:
Allow: INVITE,ACK,CANCEL,OPTIONS,BYE
Allow-Events: reg
Accept: application/sdp,application/3gpp-ims+xml
P-Called-Party-ID: <sip:UEa1_public_1@under.test.com>
Content-Type: application/sdp
Content-Length: 154

v=0
o=UEa2 2890844526 2890844526 IN IP6 nodea2.under.test.com
s=-
c=IN IP6 nodea2.under.test.com
t=0 0
m=audio 49172 RTP/AVP 0
b=AS:75
a=rtpmap:0 PCMU/8000

4. 482 Loop Detected NUT -> P-CSCFa3

SIP/2.0 482 Loop Detected

Via: SIP/2.0/UDP p.a1.under.test.com:10001;branch=z9hG4bK431e418c234;
received=3ffe:501:ffff:100::10,SIP/2.0/UDP s.a1.under.test.com;branch=z9hG4bK431e418c4.3;
received=3ffe:501:ffff:100::30,SIP/2.0/UDP i.a2.under.test.com;branch=z9hG4bKnashds418c5b;
received=3ffe:501:ffff:100::20,SIP/2.0/UDP s.a2.under.test.com;branch=z9hG4bK721e418c657u;
received=3ffe:501:ffff:200::30,SIP/2.0/UDP p.a2.under.test.com;branch=z9hG4bKnaghc45ca8;
received=3ffe:501:ffff:200::10,SIP/2.0/UDP [3ffe:501:ffff:2000::1000]:22222;branch=z9hG4bKnashds45ba91
From: <sip:UEa2_public_1@under.test.com>;tag=10fxced76sl
To: <sip:UEa1_public_1@under.test.com>;tag=414260
Call-ID: 3848276298220188511@under.test.com
CSeq: 1 INVITE
Content-Length: 0



5. ACK P-CSCFa3 -> NUT

ACK sip:UEa1_public_1@node.under.test.com:1357 SIP/2.0
Via: SIP/2.0/UDP p.a1.under.test.com:10001;branch=z9hG4bK431e418c234
Max-Forwards: 65
From: <sip:UEa2_public_1@under.test.com>;tag=10fxcde76sl
To: <sip:UEa1_public_1@under.test.com>;tag=414260
Call-ID: 3848276298220188511@under.test.com
CSeq: 1 ACK
Content-Length: 0

6. 200 OK NUT -> P-CSCF

SIP/2.0 200 OK
Via: SIP/2.0/UDP p.a1.under.test.com:10001;branch=z9hG4bK431e418c233;
received=3ffe:501:ffff:100::10,SIP/2.0/UDP s.a1.under.test.com;branch=z9hG4bK431e418c4.2;
received=3ffe:501:ffff:100::30,SIP/2.0/UDP i.a1.under.test.com;branch=z9hG4bKnashds418c5a;
received=3ffe:501:ffff:100::20,SIP/2.0/UDP s.a2.under.test.com;branch=z9hG4bK721e418c657u;
received=3ffe:501:ffff:200::30,SIP/2.0/UDP p.a2.under.test.com;branch=z9hG4bKnaghc45ca8;
received=3ffe:501:ffff:200::10,SIP/2.0/UDP [3ffe:501:ffff:2000::1000]:22222;branch=z9hG4bKnashds45ba91
Record-Route: <sip:p.a1.under.test.com:10001;lr>,<sip:s.a1.under.test.com;lr>,
<sip:s.a2.under.test.com;lr>,<sip:p.a2.under.test.com;lr>
From: <sip:UEa2_public_1@under.test.com>;tag=10fxcde76sl
To: <sip:UEa1_public_1@under.test.com>;tag=414259
Call-ID: 3848276298220188511@under.test.com
CSeq: 1 INVITE
Contact: <sip:UEa1_public_1@node.under.test.com:1357>
Supported:
Allow: INVITE,ACK,CANCEL,OPTIONS,BYE
Allow-Events: reg
Content-Type: application/sdp
Content-Length: 153

v=0
o=UEa1 2890844527 2890844527 IN IP6 node.under.test.com
s=-
c=IN IP6 node.under.test.com
t=0 0
m=audio 3456 RTP/AVP 0
b=AS:75
a=rtpmap:0 PCMU/8000

7. ACK P-CSCF -> NUT



ACK sip:UEa1_public_1@node.under.test.com:1357 SIP/2.0
Via: SIP/2.0/UDP p.a1.under.test.com:10001;branch=z9hG4bK431e418c234,
SIP/2.0/UDP s.a1.under.test.com;branch=z9hG4bK431e418c4.3;received=3ffe:501:ffff:100::30,
SIP/2.0/UDP s.a2.under.test.com;branch=z9hG4bK721e418c657v;received=3ffe:501:ffff:200::30,
SIP/2.0/UDP p.a2.under.test.com;branch=z9hG4bKnaghc45ca9;received=3ffe:501:ffff:200::10,
SIP/2.0/UDP [3ffe:501:ffff:2000::1000]:22222;branch=z9hG4bKnashds45ba92
Max-Forwards: 66
From: <sip:UEa2_public_1@under.test.com>;tag=10fxced76sl
To: <sip:UEa1_public_1@under.test.com>;tag=414259
Call-ID: 3848276298220188511@under.test.com
CSeq: 1 ACK
Content-Length: 0

8. BYE P-CSCF -> NUT

BYE sip:UEa1_public_1@node.under.test.com:1357 SIP/2.0
Via: SIP/2.0/UDP p.a1.under.test.com:10001;branch=z9hG4bK431e418c235,
SIP/2.0/UDP s.a1.under.test.com;branch=z9hG4bK431e418c4.4;received=3ffe:501:ffff:100::30,
SIP/2.0/UDP s.a2.under.test.com;branch=z9hG4bK721e418c657x;received=3ffe:501:ffff:200::30,
SIP/2.0/UDP p.a2.under.test.com;branch=z9hG4bKnaghc45ca10;received=3ffe:501:ffff:200::10,
SIP/2.0/UDP [3ffe:501:ffff:2000::1000]:22222;branch=z9hG4bKnashds45ba93
Max-Forwards: 66
From: <sip:UEa2_public_1@under.test.com>;tag=10fxced76sl
To: <sip:UEa1_public_1@under.test.com>;tag=414259
Call-ID: 3848276298220188511@under.test.com
CSeq: 2 BYE
Content-Length: 0

9. 200 OK NUT -> P-CSCF

SIP/2.0 200 OK
Via: SIP/2.0/UDP p.a1.under.test.com:10001;branch=z9hG4bK431e418c235;
received=3ffe:501:ffff:100::10,SIP/2.0/UDP s.a1.under.test.com;branch=z9hG4bK431e418c4.4;
received=3ffe:501:ffff:100::30,SIP/2.0/UDP s.a2.under.test.com;branch=z9hG4bK721e418c657x;
received=3ffe:501:ffff:200::30,SIP/2.0/UDP p.a2.under.test.com;branch=z9hG4bKnaghc45ca10;
received=3ffe:501:ffff:200::10,SIP/2.0/UDP [3ffe:501:ffff:2000::1000]:22222;branch=z9hG4bKnashds45ba93
From: <sip:UEa2_public_1@under.test.com>;tag=10fxced76sl
To: <sip:UEa1_public_1@under.test.com>;tag=414259
Call-ID: 3848276298220188511@under.test.com
CSeq: 2 BYE
Content-Length: 0



[OBSERVABLE RESULTS]

*1: 4 482 Loop Detected from NUT to P-CSCF.

See generic_3XX-6XX

- Exception{

* To

If a request contained a To tag in the request, the To header field in the response MUST equal that of the request.[RFC3261-8.2-41]

The same tag MUST be used for all responses to that request, both final and provisional. [RFC3261-8.2-44])

}

4.6.11 UE-SR-B-11-AKA - Sending 489 response

[NAME]

UE-SR-B-11-AKA - Sending 489 response.

[TARGET]

IMS User Equipment (NUT)

[PURPOSE]

To verify that UEa1 sends 489(Bad Event) response to NOTIFY request that included Event header with wrong value.

[REFERENCE]

TS24.229 A.2.1.4.1

RFC3265 3.1.6.1

RFC3265 3.2.4

[REQUIREMENT]

NONE

[PARAMETER(NUT)]

public-user-id : sip:UEa1_public_1@under.test.com



```
private-user-id      :      UEa1_private@under.test.com
contact_URI          :      sip:UEa1_public_1@node.under.test.com
HOMENETWORK Domain  :      sip:under.test.com
```

[PARAMETER(TESTER)]

```
P-CSCFa1           :      sip:p.a1.under.test.com
S-CSCFa1           :      sip:s.a1.under.test.com
```

[ADDRESS]

```
UEa1(NUT)          :      3ffe:501:fff:1000::1000
Router(R1)         :      3ffe:501:fff:1000::1
P-CSCFa1           :      3ffe:501:fff:100::10
I-CSCFa1           :      3ffe:501:fff:100::20
S-CSCFa1           :      3ffe:501:fff:100::30
DNS                 :      3ffe:501:fff:100::40
DHCP                :      3ffe:501:fff:100::50
```

[TOPOLOGY]

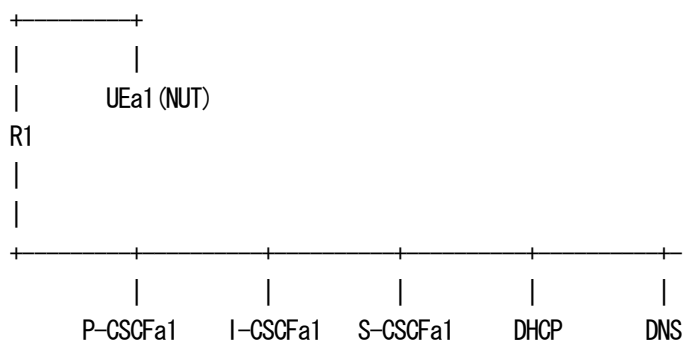

[INITIALIZATION]

Set up IP Address by A or B.

A. Router Advertisement

B. DHCPv6

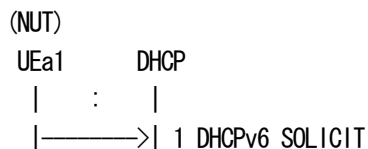

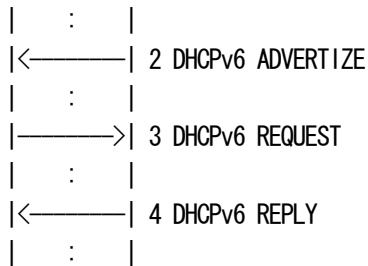

[PROCEDURE]

Home Network

(NUT)

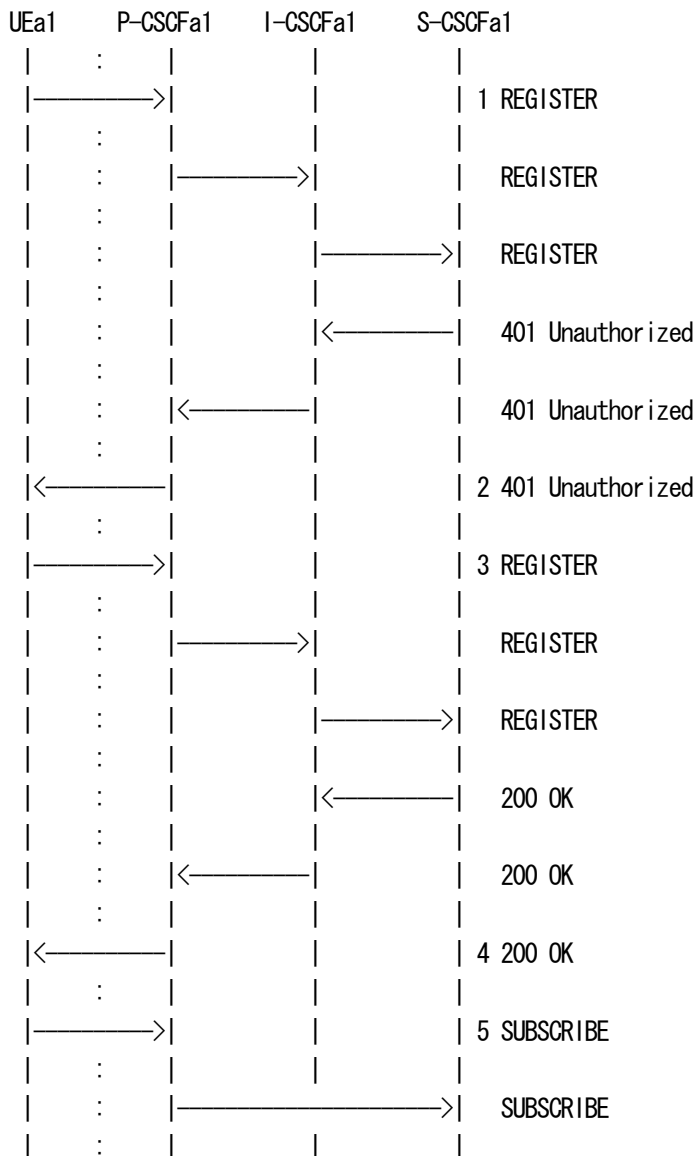

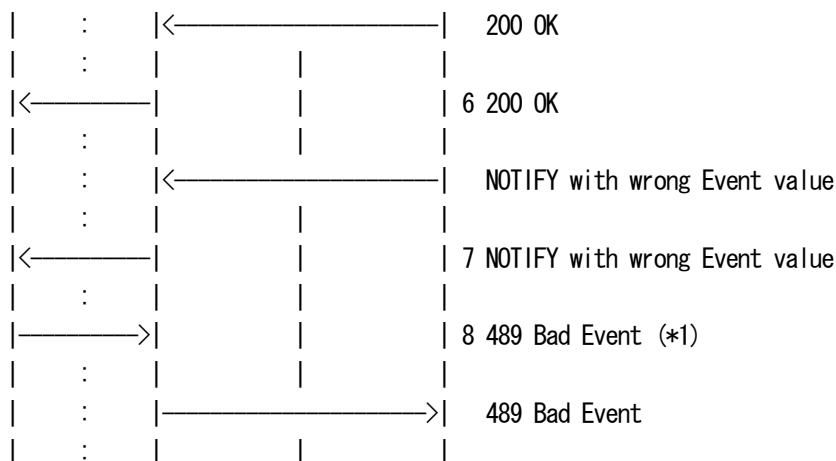

- 1 NUT sends REGISTER
- 2 NUT receives 401 Unauthorized
- 3 NUT sends REGISTER
- 4 NUT receives 200 OK
- 5 NUT sends SUBSCRIBE
- 6 NUT receives 200 OK
- 7 NUT receives NOTIFY
- 8 NUT sends 489 Bad Event

=== Message example ===

As regards the message 1-6, please refer to the message 1-6 in UE-RG-B-1-AKA.

7. NOTIFY P-CSCFa1 -> NUT

```
NOTIFY sip:UEa1_public_1@node.under.test.com:1357 SIP/2.0
Via: SIP/2.0/UDP p.a1.under.test.com:10001;branch=z9hG4bK240f34.1,
SIP/2.0/UDP s.a1.under.test.com;branch=z9hG4bK332b23.1;received=3ffe:501:ffff:100::30
Max-Forwards: 69
From: <sip:UEa1_public_1@under.test.com>;tag=151170
To: <sip:UEa1_public_1@under.test.com>;tag=31415
Call-ID: b89rjhnedlrfjflj40a222@under.test.com
CSeq: 2 NOTIFY
Contact: <sip:s.a1.under.test.com>
Subscription-State: active;expires=600000
Event: foo
Content-Type: application/reginfo+xml
Content-Length: (...)
```



```
<?xml version="1.0"?>
<reginfo xmlns="urn:ietf:params:xml:ns:reginfo" version="0" state="full">
  <registration aor="sip:UEa1_public_1@under.test.com" id="a7" state="active">
    <contact id="76" state="active" event="registered">
      <uri>sip:UEa1_public_1@node.under.test.com</uri>
    </contact>
  </registration>
</reginfo>
```

8. 489 Bad Event NUT -> P-CSCFa1

SIP/2.0 489 Bad Event

Via: SIP/2.0/UDP p.a1.under.test.com:10001;branch=z9hG4bK240f34.1;

received=3ffe:501:ffff:100::10,SIP/2.0/UDP s.a1.under.test.com;branch=z9hG4bK332b23.1;

received=3ffe:501:ffff:100::30

From: <sip:UEa1_public_1@under.test.com>;tag=151170

To: <sip:UEa1_public_1@under.test.com>;tag=31415

Call-ID: b89rjhnedlrfflsij40a222@under.test.com

CSeq: 2 NOTIFY

Allow-Events: reg

Content-Length: 0

[OBSERVABLE RESULTS]

*1: 8 489 Bad Even from NUT to P-CSCF.

See generic_3XX-6XX

- Exception{

* To

-If the To header field in the request did not contain a tag, the URI in the To header field in the response MUST equal the URI in the To header field. [RFC3261-8.2-42]

-If the To header field in the request did not contain a tag, the UAS MUST add a tag to the To header field in the response. [RFC3261-8.2-43]

}

4.6.12 UE-SR-B-12-AKA - Sending 500 response



[NAME]

UE-SR-B-12-AKA - Sending 500 response.

[TARGET]

IMS User Equipment (NUT)

[PURPOSE]

To verify that UEa1 sends 500 response to BYE request that included CSeq header with wrong value (smaller than INVITE's).

[REFERENCE]

TS24.229 A.2.1.4.1

RFC3261 12.2.2

[REQUIREMENT]

NONE

[PARAMETER(NUT)]

public-user-id : sip:UEa1_public_1@under.test.com
private-user-id : UEa1_private@under.test.com
contact_URI : sip:UEa1_public_1@node.under.test.com
HOMENETWORK Domain : sip:under.test.com

[PARAMETER(TESTER)]

public-user-id(UEa2) : sip:UEa2_public_1@under.test.com
P-CSCFa1 : sip:p.a1.under.test.com

[ADDRESS]

UEa1(NUT) : 3ffe:501:fff:1000::1000
Router(R1) : 3ffe:501:fff:1000::1
P-CSCFa1 : 3ffe:501:fff:100::10
I-CSCFa1 : 3ffe:501:fff:100::20
S-CSCFa1 : 3ffe:501:fff:100::30
DNS : 3ffe:501:fff:100::40
DHCP : 3ffe:501:fff:100::50

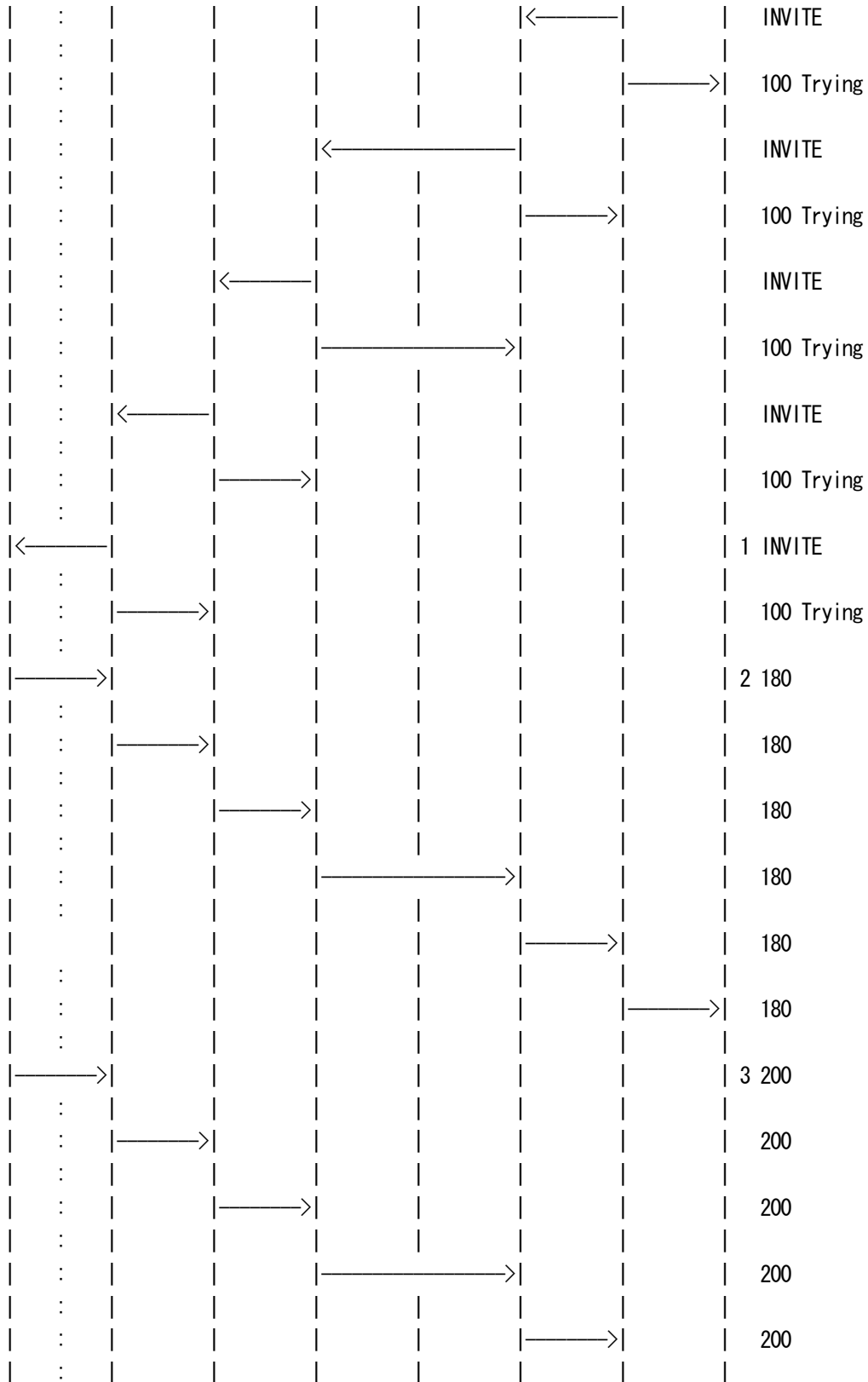

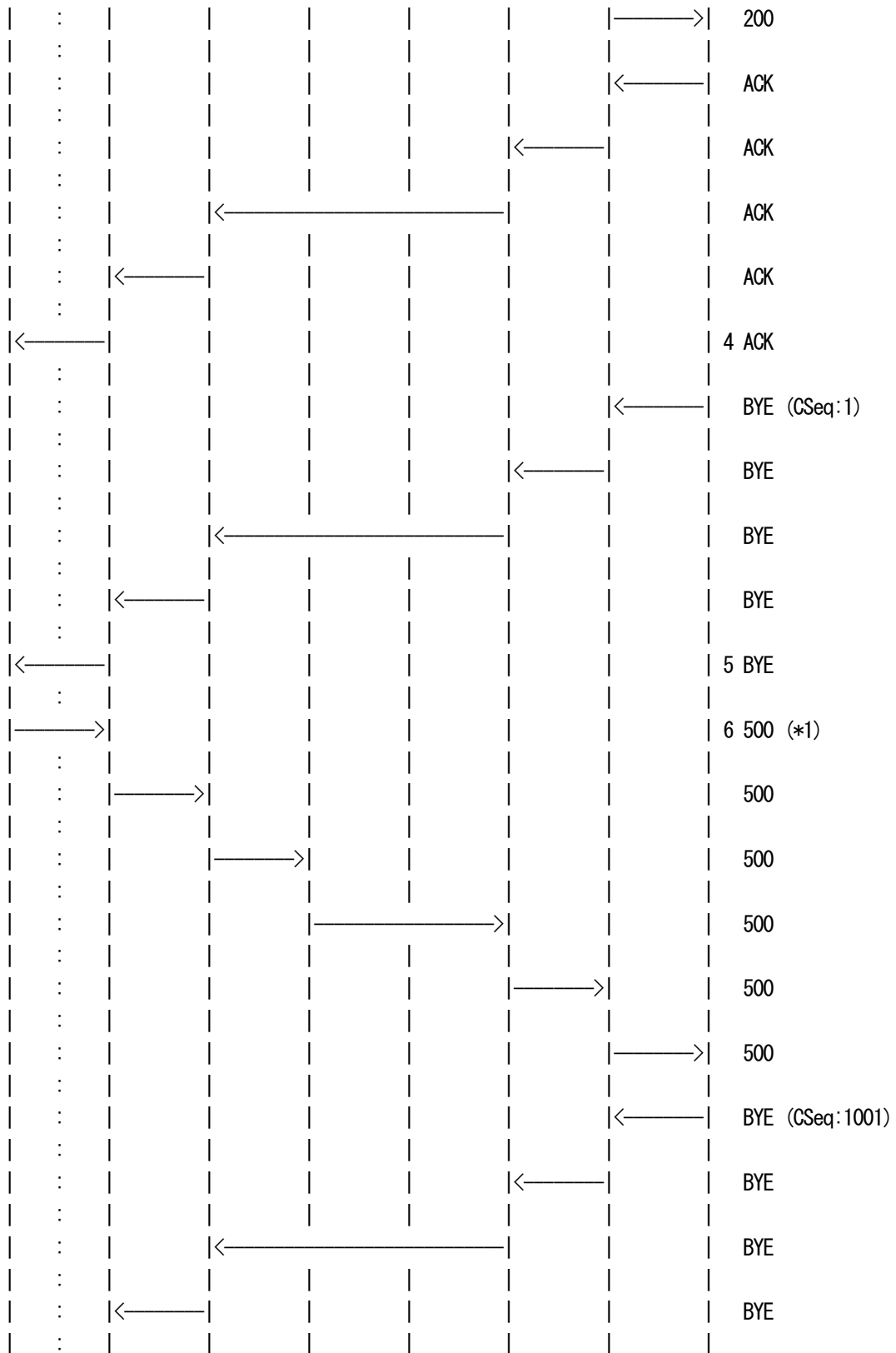



Allow-Events: reg
Accept: application/sdp,application/3gpp-ims+xml
P-Called-Party-ID: <sip:UEa1_public_1@under.test.com>
Content-Type: application/sdp
Content-Length: 154

v=0
o=UEa2 2890844526 2890844526 IN IP6 nodea2.under.test.com
s=-
c=IN IP6 nodea2.under.test.com
t=0 0
m=audio 49172 RTP/AVP 0
b=AS:75
a=rtpmap:0 PCMU/8000

2. 180 Ringing NUT -> P-CSCF

SIP/2.0 180 Ringing
Via: SIP/2.0/UDP p.a1.under.test.com:10001;branch=z9hG4bK431e418c233;
received=3ffe:501:ffff:100::10,SIP/2.0/UDP s.a1.under.test.com;branch=z9hG4bK431e418c4.2;
received=3ffe:501:ffff:100::30,SIP/2.0/UDP i.a1.under.test.com;branch=z9hG4bKnashds418c5a;
received=3ffe:501:ffff:100::20,SIP/2.0/UDP s.a2.under.test.com;branch=z9hG4bK721e418c657u;
received=3ffe:501:ffff:200::30,SIP/2.0/UDP p.a2.under.test.com;branch=z9hG4bKnaghc45ca8;
received=3ffe:501:ffff:200::10,SIP/2.0/UDP [3ffe:501:ffff:2000::1000]:22222;branch=z9hG4bKnashds45ba91
From: <sip:UEa2_public_1@under.test.com>;tag=10fxcde76sl
To: <sip:UEa1_public_1@under.test.com>;tag=414259
Call-ID: 3848276298220188511@under.test.com
CSeq: 1000 INVITE
Content-Length: 0

3. 200 OK NUT -> P-CSCF

SIP/2.0 200 OK
Via: SIP/2.0/UDP p.a1.under.test.com:10001;branch=z9hG4bK431e418c233;
received=3ffe:501:ffff:100::10,SIP/2.0/UDP s.a1.under.test.com;branch=z9hG4bK431e418c4.2;
received=3ffe:501:ffff:100::30,SIP/2.0/UDP i.a1.under.test.com;branch=z9hG4bKnashds418c5a;
received=3ffe:501:ffff:100::20,SIP/2.0/UDP s.a2.under.test.com;branch=z9hG4bK721e418c657u;
received=3ffe:501:ffff:200::30,SIP/2.0/UDP p.a2.under.test.com;branch=z9hG4bKnaghc45ca8;
received=3ffe:501:ffff:200::10,SIP/2.0/UDP [3ffe:501:ffff:2000::1000]:22222;branch=z9hG4bKnashds45ba91
Record-Route: <sip:p.a1.under.test.com:10001;lr>,<sip:s.a1.under.test.com;lr>,
<sip:s.a2.under.test.com;lr>,<sip:p.a2.under.test.com;lr>
From: <sip:UEa2_public_1@under.test.com>;tag=10fxcde76sl
To: <sip:UEa1_public_1@under.test.com>;tag=414259



Call-ID: 3848276298220188511@under.test.com
CSeq: 1000 INVITE
Contact: <sip:UEa1_public_1@node.under.test.com:1357>
Supported:
Allow: INVITE,ACK,CANCEL,OPTIONS,BYE
Allow-Events: reg
Content-Type: application/sdp
Content-Length: 153

v=0
o=UEa1 2890844527 2890844527 IN IP6 node.under.test.com
s=-
c=IN IP6 node.under.test.com
t=0 0
m=audio 3456 RTP/AVP 0
b=AS:75
a=rtpmap:0 PCMU/8000

4. ACK P-CSCF -> NUT

ACK sip:UEa1_public_1@node.under.test.com:1357 SIP/2.0
Via: SIP/2.0/UDP p.a1.under.test.com:10001;branch=z9hG4bK431e418c234,
SIP/2.0/UDP s.a1.under.test.com;branch=z9hG4bK431e418c4.3;received=3ffe:501:ffff:100::30,
SIP/2.0/UDP s.a2.under.test.com;branch=z9hG4bK721e418c657v;received=3ffe:501:ffff:200::30,
SIP/2.0/UDP p.a2.under.test.com;branch=z9hG4bKnaghc45ca9;received=3ffe:501:ffff:200::10,
SIP/2.0/UDP [3ffe:501:ffff:2000::1000]:22222;branch=z9hG4bKnashds45ba92
Max-Forwards: 66
From: <sip:UEa2_public_1@under.test.com>;tag=10fxced76sl
To: <sip:UEa1_public_1@under.test.com>;tag=414259
Call-ID: 3848276298220188511@under.test.com
CSeq: 1000 ACK
Content-Length: 0

5. BYE P-CSCF -> NUT

BYE sip:UEa1_public_1@node.under.test.com:1357 SIP/2.0
Via: SIP/2.0/UDP p.a1.under.test.com:10001;branch=z9hG4bK431e418c235,
SIP/2.0/UDP s.a1.under.test.com;branch=z9hG4bK431e418c4.4;received=3ffe:501:ffff:100::30,
SIP/2.0/UDP s.a2.under.test.com;branch=z9hG4bK721e418c657x;received=3ffe:501:ffff:200::30,
SIP/2.0/UDP p.a2.under.test.com;branch=z9hG4bKnaghc45ca10;received=3ffe:501:ffff:200::10,
SIP/2.0/UDP [3ffe:501:ffff:2000::1000]:22222;branch=z9hG4bKnashds45ba93
Max-Forwards: 66
From: <sip:UEa2_public_1@under.test.com>;tag=10fxced76sl



To: <sip:UEa1_public_1@under.test.com>;tag=414259
Call-ID: 3848276298220188511@under.test.com
CSeq: 1 BYE
Content-Length: 0

6. 500 Server Internal Error NUT -> P-CSCF

SIP/2.0 500 Server Internal Error

Via: SIP/2.0/UDP p.a1.under.test.com:10001;branch=z9hG4bK431e418c235;
received=3ffe:501:ffff:100::10,SIP/2.0/UDP s.a1.under.test.com;branch=z9hG4bK431e418c4.4;
received=3ffe:501:ffff:100::30,SIP/2.0/UDP s.a2.under.test.com;branch=z9hG4bK721e418c657x;
received=3ffe:501:ffff:200::30,SIP/2.0/UDP p.a2.under.test.com;branch=z9hG4bKnaghc45ca10;
received=3ffe:501:ffff:200::10,SIP/2.0/UDP [3ffe:501:ffff:2000::1000]:22222;branch=z9hG4bKnashds45ba93
From: <sip:UEa2_public_1@under.test.com>;tag=10fxcdd76sl
To: <sip:UEa1_public_1@under.test.com>;tag=414259
Call-ID: 3848276298220188511@under.test.com
CSeq: 1 BYE
Content-Length: 0

7. BYE P-CSCF -> NUT

BYE sip:UEa1_public_1@node.under.test.com:1357 SIP/2.0

Via: SIP/2.0/UDP p.a1.under.test.com:10001;branch=z9hG4bK431e418c235,
SIP/2.0/UDP s.a1.under.test.com;branch=z9hG4bK431e418c4.4;received=3ffe:501:ffff:100::30,
SIP/2.0/UDP s.a2.under.test.com;branch=z9hG4bK721e418c657x;received=3ffe:501:ffff:200::30,
SIP/2.0/UDP p.a2.under.test.com;branch=z9hG4bKnaghc45ca10;received=3ffe:501:ffff:200::10,
SIP/2.0/UDP [3ffe:501:ffff:2000::1000]:22222;branch=z9hG4bKnashds45ba93
Max-Forwards: 66
From: <sip:UEa2_public_1@under.test.com>;tag=10fxcdd76sl
To: <sip:UEa1_public_1@under.test.com>;tag=414259
Call-ID: 3848276298220188511@under.test.com
CSeq: 1001 BYE
Content-Length: 0

8. 200 OK NUT -> P-CSCF

SIP/2.0 200 OK

Via: SIP/2.0/UDP p.a1.under.test.com:10001;branch=z9hG4bK431e418c235;
received=3ffe:501:ffff:100::10,SIP/2.0/UDP s.a1.under.test.com;branch=z9hG4bK431e418c4.4;
received=3ffe:501:ffff:100::30,SIP/2.0/UDP s.a2.under.test.com;branch=z9hG4bK721e418c657x;
received=3ffe:501:ffff:200::30,SIP/2.0/UDP p.a2.under.test.com;branch=z9hG4bKnaghc45ca10;
received=3ffe:501:ffff:200::10,SIP/2.0/UDP [3ffe:501:ffff:2000::1000]:22222;branch=z9hG4bKnashds45ba93
From: <sip:UEa2_public_1@under.test.com>;tag=10fxcdd76sl



To: <sip:UEa1_public_1@under.test.com>;tag=414259
Call-ID: 3848276298220188511@under.test.com
CSeq: 1001 BYE
Content-Length: 0

[OBSERVABLE RESULTS]

*1: 6 500 Server Internal Error from NUT to P-CSCF.

See generic_3XX-6XX

- Exception{

* To

If the To header field in the request did not contain a tag, the URI
in the To header field in the response MUST equal the URI in the To
header field. [RFC3261-8.2-42]

If the To header field in the request did not contain a tag, the UAS
MUST add a tag to the To header field in the response. [RFC3261-8.2-43]

}

4.6.13 UE-SR-B-13-AKA - Sending 505 response

[NAME]

UE-SR-B-13-AKA - Sending 505 response.

[TARGET]

IMS User Equipment (NUT)

[PURPOSE]

To verify that UEa1 sends 505 (Version Not Supported) response to INVITE that has
illegal SIP version in Request-Line.

[REFERENCE]

TS24.229 A.2.1.4.1

RFC3261 21.5.6



[REQUIREMENT]

NONE

[PARAMETER(NUT)]

public-user-id : sip:UEa1_public_1@under.test.com
private-user-id : UEa1_private@under.test.com
contact_URI : sip:UEa1_public_1@node.under.test.com
HOMENETWORK Domain : sip:under.test.com

[PARAMETER(TESTER)]

public-user-id(UEa2) : sip:UEa2_public_1@under.test.com
P-CSCFa1 : sip:p.a1.under.test.com

[ADDRESS]

UEa1(NUT) : 3ffe:501:fff:1000::1000
Router(R1) : 3ffe:501:fff:1000::1
P-CSCFa1 : 3ffe:501:fff:100::10
I-CSCFa1 : 3ffe:501:fff:100::20
S-CSCFa1 : 3ffe:501:fff:100::30
DNS : 3ffe:501:fff:100::40
DHCP : 3ffe:501:fff:100::50

UEa2 : 3ffe:501:fff:2000::1000
P-CSCFa2 : 3ffe:501:fff:200::10
I-CSCFa2 : 3ffe:501:fff:200::20
S-CSCFa2 : 3ffe:501:fff:200::30

[TOPOLOGY]

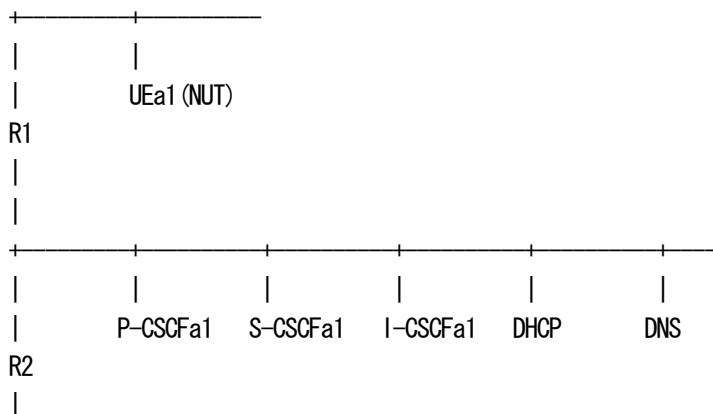

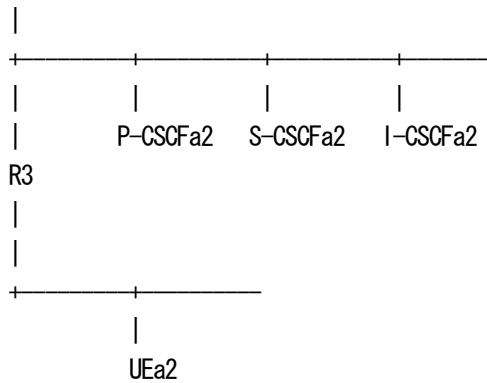

[INITIALIZATION]

UEa1 (NUT) must be registered with the tester by executing the scenario "UE-INI-B-1-AKA".
For details of "UE-INI-B-1-AKA", refer to the profile "UE-RG-B-1-AKA".

[PROCEDURE]

Home Network

(NUT)

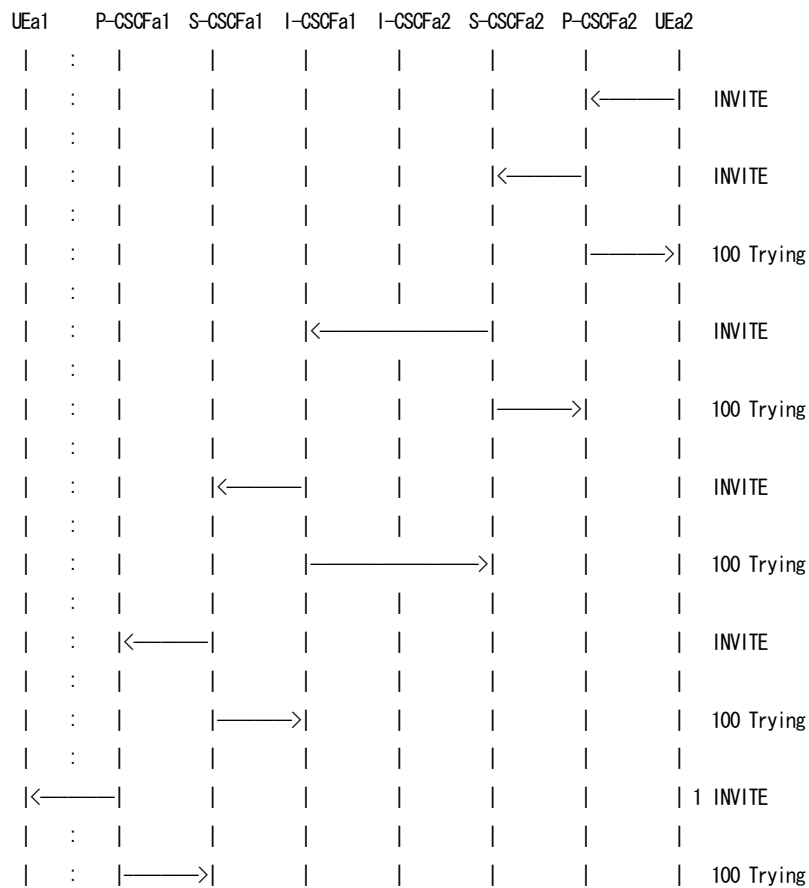

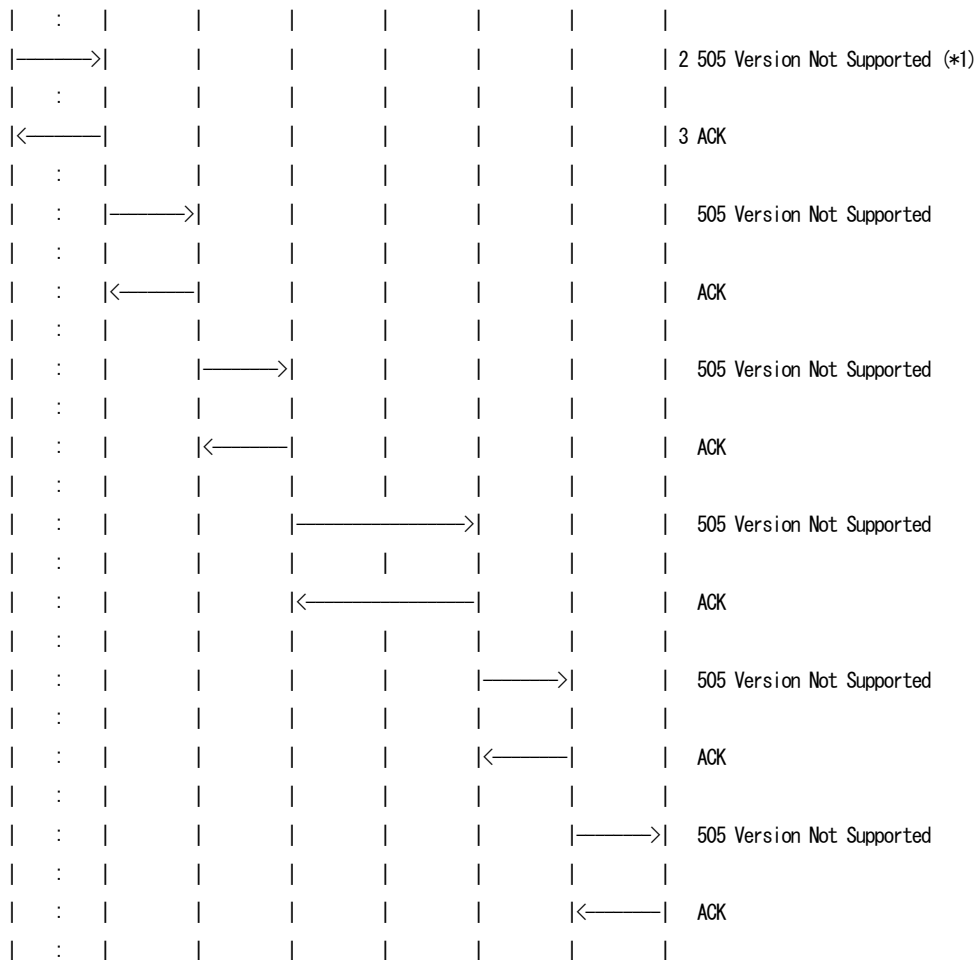

- 1 NUT receives INVITE.
- 2 NUT sends 505 Version Not Supported.
- 3 NUT receives ACK.

=== Message example ===

1. INVITE P-CSCF -> NUT

```

INVITE sip:UEa1_public_1@node.under.test.com:1357 SIP/9.8
Via: SIP/2.0/UDP p.a1.under.test.com:10001;branch=z9hG4bK431e418c233,
SIP/2.0/UDP s.a1.under.test.com;branch=z9hG4bK431e418c4.2;received=3ffe:501:ffff:100::30,
SIP/2.0/UDP i.a1.under.test.com;branch=z9hG4bKnashds418c5a;received=3ffe:501:ffff:100::20,
SIP/2.0/UDP s.a2.under.test.com;branch=z9hG4bK721e418c657u;received=3ffe:501:ffff:200::30,
SIP/2.0/UDP p.a2.under.test.com;branch=z9hG4bKnaghc45ca8;received=3ffe:501:ffff:200::10,
SIP/2.0/UDP [3ffe:501:ffff:2000::1000]:22222;branch=z9hG4bKnashds45ba91
Record-Route: <sip:p.a1.under.test.com:10001;lr>,<sip:s.a1.under.test.com;lr>,
<sip:s.a2.under.test.com;lr>,<sip:p.a2.under.test.com;lr>

```



Max-Forwards: 65
From: <sip:UEa2_public_1@under.test.com>;tag=10fxcde76sl
To: <sip:UEa1_public_1@under.test.com>
Call-ID: 3848276298220188511@under.test.com
CSeq: 1 INVITE
Contact: <sip:UEa2_public_1@nodea2.under.test.com:22222>
Supported:
Allow: INVITE,ACK,CANCEL,OPTIONS,BYE
Allow-Events: reg
Accept: application/sdp,application/3gpp-ims+xml
P-Called-Party-ID: <sip:UEa1_public_1@under.test.com>
Content-Type: application/sdp
Content-Length: 154

v=0
o=UEa2 2890844526 2890844526 IN IP6 nodea2.under.test.com
S=-
c=IN IP6 nodea2.under.test.com
t=0 0
m=audio 49172 RTP/AVP 0
b=AS:75
a=rtpmap:0 PCMU/8000

2. 505 Version Not Supported NUT -> P-CSCF

SIP/2.0 505 Version Not Supported

Via: SIP/2.0/UDP p.a1.under.test.com:10001;branch=z9hG4bK431e418c233;
received=3ffe:501:ffff:100::10,SIP/2.0/UDP s.a1.under.test.com;branch=z9hG4bK431e418c4.2;
received=3ffe:501:ffff:100::30,SIP/2.0/UDP i.a1.under.test.com;branch=z9hG4bKnashds418c5a;
received=3ffe:501:ffff:100::20,SIP/2.0/UDP s.a2.under.test.com;branch=z9hG4bK721e418c657u;
received=3ffe:501:ffff:200::30,SIP/2.0/UDP p.a2.under.test.com;branch=z9hG4bKnaghc45ca8;
received=3ffe:501:ffff:200::10,SIP/2.0/UDP [3ffe:501:ffff:2000::1000]:22222;
branch=z9hG4bKnashds45ba91

From: <sip:UEa2_public_1@under.test.com>;tag=10fxcde76sl
To: <sip:UEa1_public_1@under.test.com>;tag=414259
Call-ID: 3848276298220188511@under.test.com
CSeq: 1 INVITE
Content-Length: 0

3. ACK P-CSCF -> NUT

ACK sip:UEa1_public_1@node.under.test.com:1357 SIP/9.8
Via: SIP/2.0/UDP p.a1.under.test.com:10001;branch=z9hG4bK431e418c233



Max-Forwards: 65
From: <sip:UEa2_public_1@under.test.com>;tag=10fxced76sl
To: <sip:UEa1_public_1@under.test.com>;tag=414259
Call-ID: 3848276298220188511@under.test.com
CSeq: 1 ACK
Content-Length: 0

[OBSERVABLE RESULTS]

*1: 2 505 Version Not Supported from NUT to P-CSCF.

See generic_3XX-6XX

- Exception{

* To

If a request contained a To tag in the request, the To header field in the response MUST equal that of the request.[RFC3261-8.2-41]

The same tag MUST be used for all responses to that request, both final and provisional. [RFC3261-8.2-44])

}

4.7 Receiving Response

4.7.1 UE-RR-B-1-AKA - Receiving 100 response

[NAME]

UE-RR-B-1-AKA - Receiving 100 response

[TARGET]

IMS User Equipment (NUT)

[PURPOSE]

To verify that the UEa1 properly process a 100 (Trying) response.

[REFERENCE]

TS24.229 A.2.1.4.1



RFC3261 8.1.3.2
RFC3265 3.2.4

[REQUIREMENT]
NONE

[PARAMETER(NUT)]

public-user-id	:	sip:UEa1_public_1@under.test.com
private-user-id	:	UEa1_private@under.test.com
contact_URI	:	sip:UEa1_public_1@node.under.test.com
HOMENETWORK Domain	:	sip:under.test.com

[PARAMETER(TESTER)]

public-user-id(UEa2)	:	sip:UEa2_public_1@under.test.com
P-CSCFa1	:	sip:p.a1.under.test.com
S-CSCFa1	:	sip:s.a1.under.test.com

[ADDRESS]

UEa1(NUT)	:	3ffe:501:fff:1000::1000
Router(R1)	:	3ffe:501:fff:1000::1
P-CSCFa1	:	3ffe:501:fff:100::10
I-CSCFa1	:	3ffe:501:fff:100::20
S-CSCFa1	:	3ffe:501:fff:100::30
DNS	:	3ffe:501:fff:100::40
DHCP	:	3ffe:501:fff:100::50
UEa2	:	3ffe:501:fff:2000::1000
P-CSCFa2	:	3ffe:501:fff:200::10
I-CSCFa2	:	3ffe:501:fff:200::20
S-CSCFa2	:	3ffe:501:fff:200::30

[TOPOLOGY]

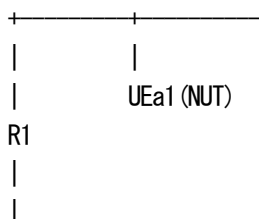

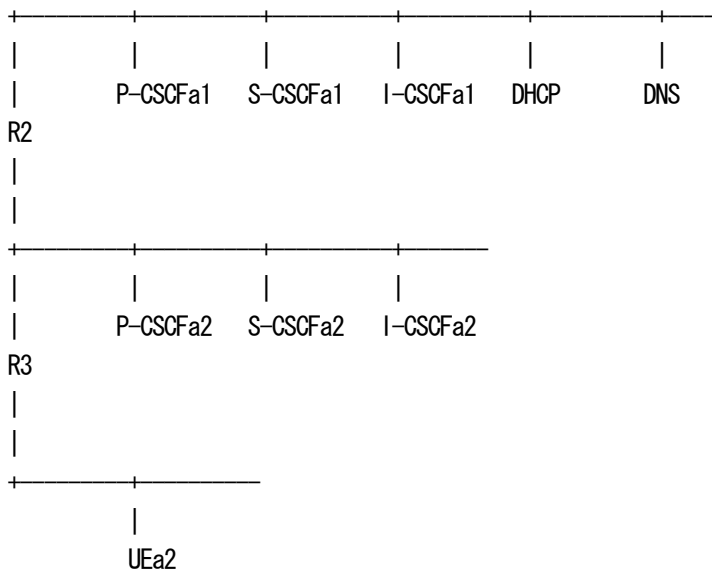

[INITIALIZATION]

Set up IP Address by A or B.

A. Router Advertisement

B. DHCPv6

(NUT)

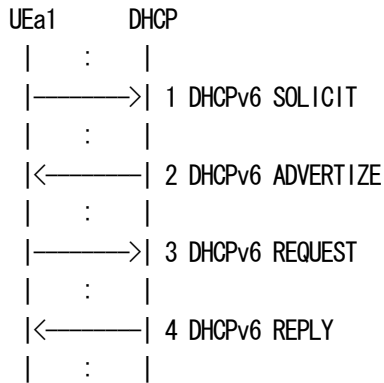

[PROCEDURE]

Home Network

(NUT)

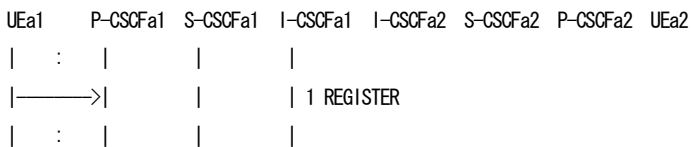



```
|<-----|           |           | 2 100 Trying
| : |           |           |
|----->|           |           | 3 REGISTER
| : |           |           |
|<-----|           |           | 4 100 Trying
| : |           |           |
| : |           |           |           :
| : |           |           |
| : |           |           | 5 <Wait 4 sec to check sending re-transmission>
| : |           |           | (Re-transmission by Timer E is sending after initial REGISTER)
| : |           |           |
| : |----->|           | REGISTER
| : |           |           |
| : |           |<-----| REGISTER
| : |           |           |
| : |           |----->| 401 Unauthorized
| : |           |           |
| : |<-----|           | 401 Unauthorized
| : |           |           |
|<-----|           |           | 6 401 Unauthorized
| : |           |           |
|----->|           |           | 7 REGISTER (*1)
| : |           |           |
| : |----->|           | REGISTER
| : |           |           |
| : |           |<-----| REGISTER
| : |           |           |
| : |           |----->| 200 OK
| : |           |           |
| : |<-----|           | 200 OK
| : |           |           |
|<-----|           |           | 8 200 OK
| : |           |           |
|----->|           |           | 9 SUBSCRIBE
| : |           |           |
|<-----|           |           | 10 100 Trying
| : |           |           |
|----->|           |           | 11 SUBSCRIBE
| : |           |           |
|<-----|           |           | 12 100 Trying
| : |           |           |
| : |           |           |           :
| : |           |           |
```



```

| : | | | 13 <Wait 4 sec to check sending re-transmission>
| : | | | (Re-transmission by Timer E is sending after initial SUBSCRIBE)
| : | | |
| : | |>| | SUBSCRIBE
| : | | |
| : | |<| | 200 OK
| : | | |
|<| | | | 14 200 OK
| : | | |
| : | |<| | NOTIFY
| : | | |
|<| | | | 15 NOTIFY
| : | | |
|>| | | | 16 200 OK (*2)
| : | | |
| : | |>| | 200 OK
| : | | |
| : | | | | | | | | |
|>| | | | | | | | | | 17 OPTIONS
| : | | | | | | | | | |
|<| | | | | | | | | | 18 100 Trying
| : | | | | | | | | | |
|>| | | | | | | | | | 19 OPTIONS
| : | | | | | | | | | |
|<| | | | | | | | | | 20 100 Trying
| : | | | | | | | | | |
| : | | | | | | | | | | :
| : | | | | | | | | | |
| : | | | | | | | | | | 21 <Wait 4 sec to check sending re-transmission>
| : | | | | | | | | | | (Re-transmission by Timer E is
| : | | | | | | | | | | sending after initial OPTIONS)
| : | |>| | | | | | | | | | OPTIONS
| : | | | |>| | | | | | | | | | OPTIONS
| : | | | | |>| | | | | | | | | | OPTIONS
| : | | | | | |>| | | | | | | | | | OPTIONS
| : | | | | | | |>| | | | | | | | | | OPTIONS
| : | | | | | | | |>| | | | | | | | | | OPTIONS
| : | | | | | | | | |<| | | | | | | | | | 200 OK

```

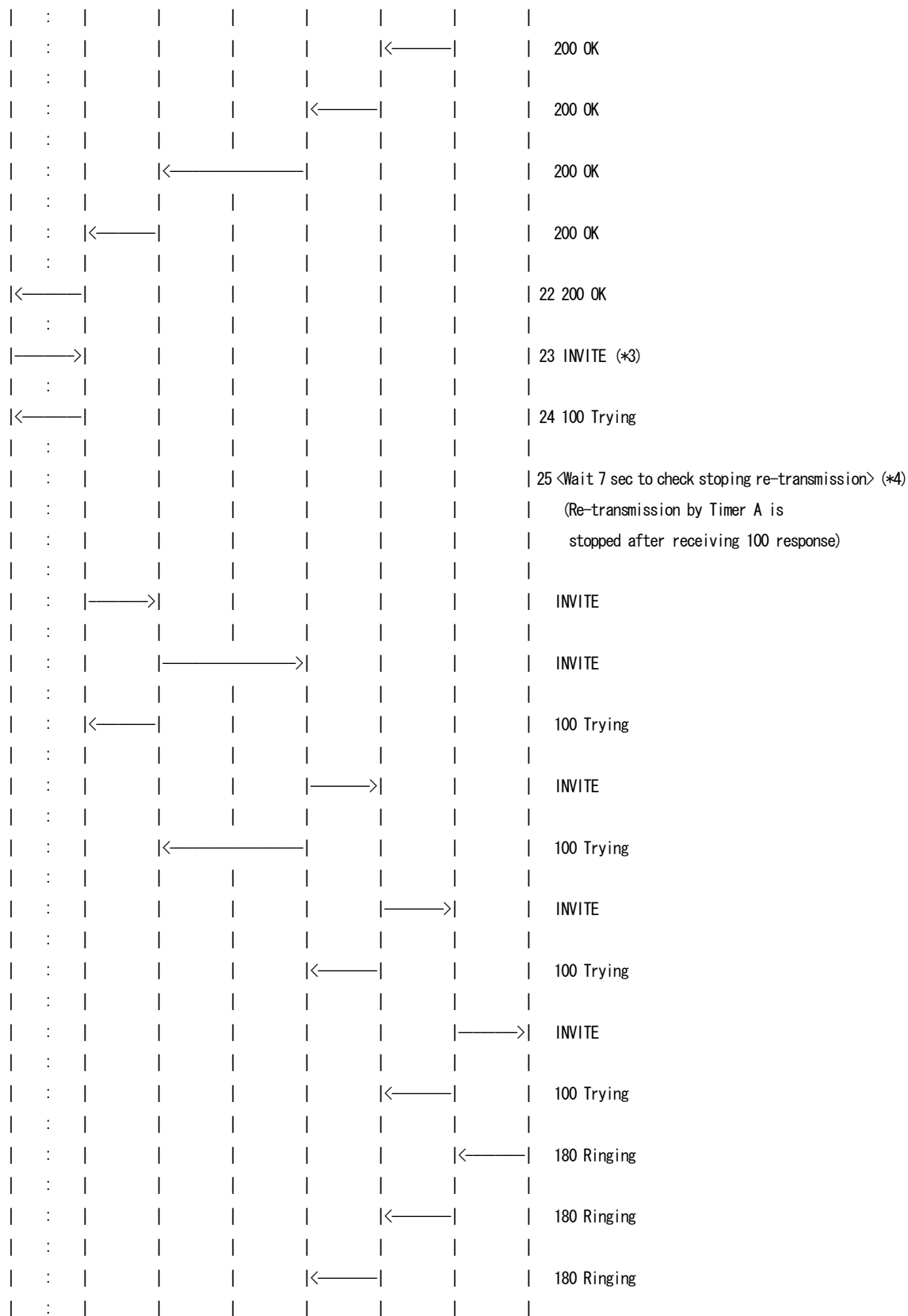

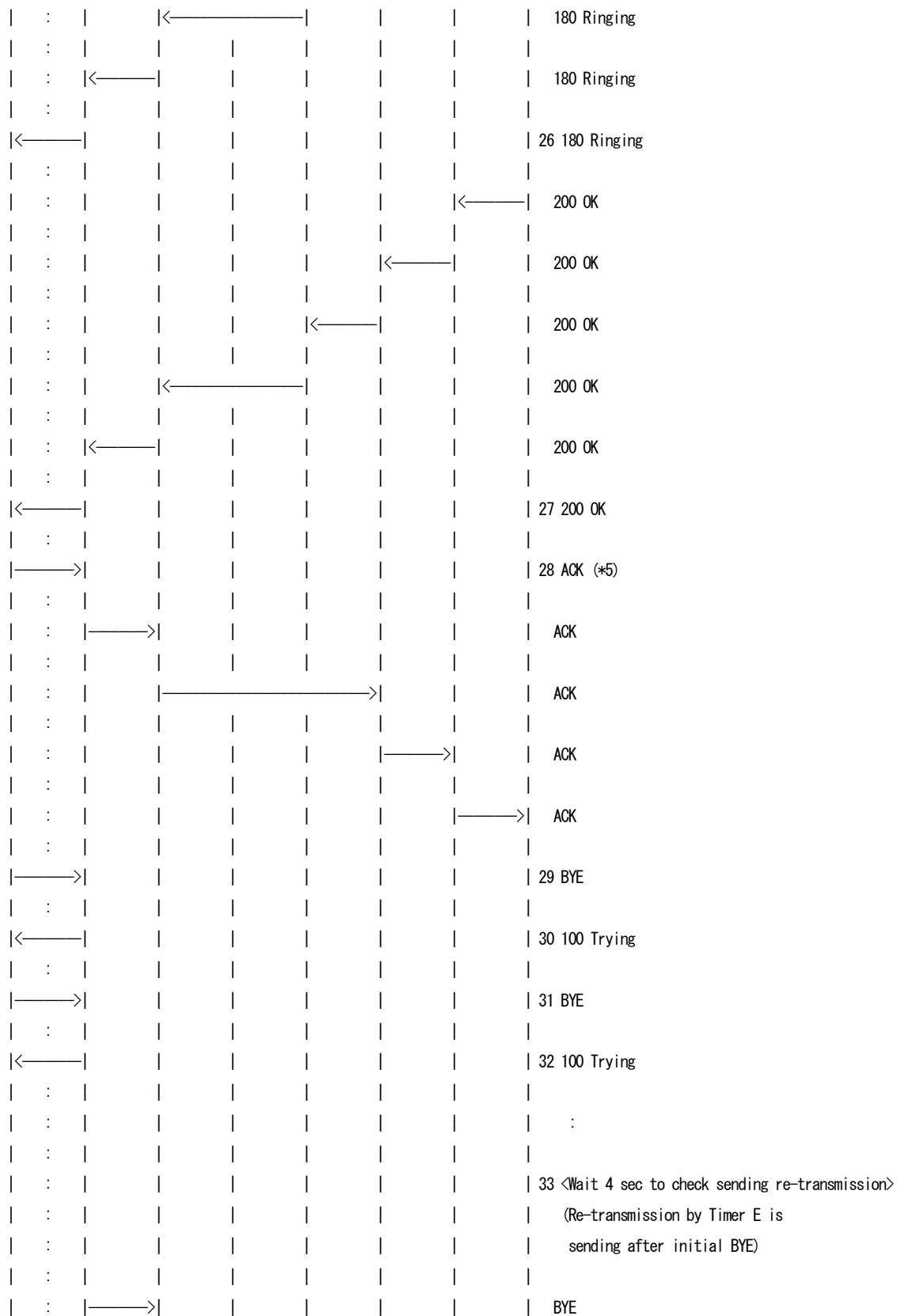

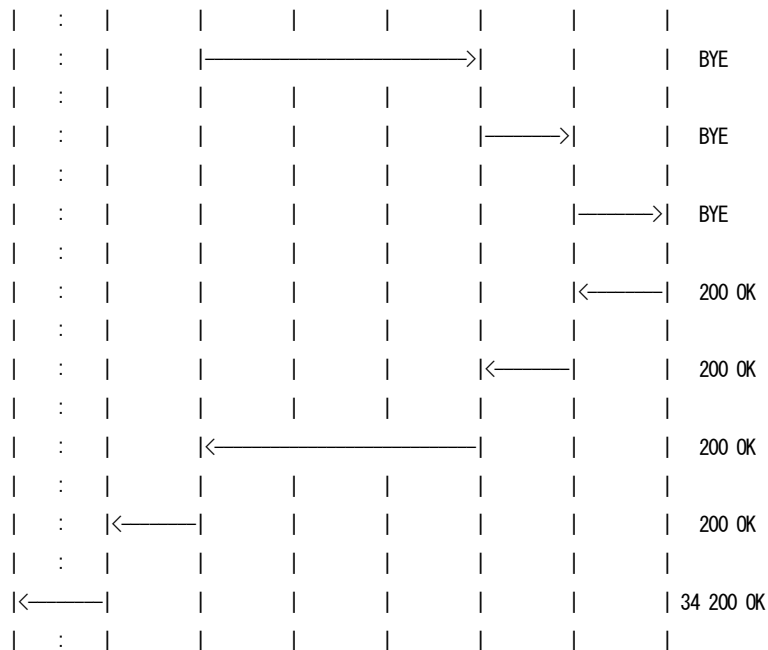

- 1 NUT sends REGISTER
- 2 NUT receives 100 Trying
- 3 NUT sends REGISTER
- 4 NUT receives 100 Trying
- 5 <Wait 4 sec to check sending re-transmission>
- 6 NUT receives 401 Unauthorized
- 7 NUT sends REGISTER for authentication
- 8 NUT receives 200 OK
- 9 NUT sends SUBSCRIBE
- 10 NUT receives 100 Trying
- 11 NUT sends SUBSCRIBE
- 12 NUT receives 100 Trying
- 13 <Wait 4 sec to check sending re-transmission>
- 14 NUT receives 200 OK
- 15 NUT receives NOTIFY
- 16 NUT sends 200 OK
- 17 NUT sends OPTIONS
- 18 NUT receives 100 Trying
- 19 NUT sends OPTIONS
- 20 NUT receives 100 Trying
- 21 <Wait 4 sec to check sending re-transmission>
- 22 NUT receives 200 OK
- 23 NUT sends INVITE
- 24 NUT receives 100 Trying
- 25 <Wait 7 sec to check stopping re-transmission>



26 NUT receives 180 Ringing
27 NUT receives 200 OK
28 NUT sends ACK
29 NUT sends BYE
30 NUT receives 100 Trying
31 NUT sends BYE
32 NUT receives 100 Trying
33 <Wait 4 sec to check stoping re-transmission>
34 NUT receives 200 OK

=== Message example ===

As regards the message 1, please refer to the message 1 in UE-RG-B-1-AKA.

2. 100 Trying P-CSCF -> NUT
SIP/2.0 100 Trying
Via: SIP/2.0/UDP [3ffe:501:ffff:1000::1000]:5060;branch=z9hG4bKnashds7
From: <sip:UEa1_public_1@under.test.com>;tag=4fa3
To: <sip:UEa1_public_1@under.test.com>
Call-ID: apb03a0s09dkjdfglkj49111@under.test.com
CSeq: 1 REGISTER
Content-Length: 0

As regards the message 3, please refer to the message 1 in UE-RG-B-1-AKA.

As regards the message 4, please refer to the message 2 in this.

5. <Wait 4 sec to check sending re-transmission.>

As regards the message 6-9, please refer to the message 2-5 in UE-RG-B-1-AKA.

10. 100 Trying P-CSCF -> NUT
SIP/2.0 100 Trying
Via: SIP/2.0/UDP [3ffe:501:ffff:1000::1000]:1357;branch=z9hG4bKnashdsa1
From: <sip:UEa1_public_1@under.test.com>;tag=31415
To: <sip:UEa1_public_1@under.test.com>



Call-ID: b89rjhnedlrffflslj40a222@under.test.com

CSeq: 1 SUBSCRIBE

Content-Length: 0

As regards the message 11, please refer to the message 5 in UE-RG-B-1-AKA.

As regards the message 12, please refer to the message 10 in this.

13. <Wait 4 sec to check sending re-transmission.>

As regards the message 14-16, please refer to the message 6-8 in UE-RG-B-1-AKA.

As regards the message 17, please refer to the message 1 in UE-OP-B-1-AKA.

18. 100 Trying P-CSCF -> NUT

SIP/2.0 100 Trying

Via: SIP/2.0/UDP [3ffe:501:ffff:1000::1000]:1357;branch=z9hG4bK74b1a

From: <sip:UEa1_public_1@under.test.com>;tag=9fxced76tm

To: <sip:UEa2_public_1@under.test.com>

Call-ID: 3848276298220188522@under.test.com

CSeq: 1 OPTIONS

Content-Length: 0

As regards the message 19, please refer to the message 1 in UE-OP-B-1-AKA.

As regards the message 20, please refer to the message 18 in this.

21. <Wait 4 sec to check sending re-transmission.>

As regards the message 22, please refer to the message 2 in UE-OP-B-1-AKA.

As regards the message 23, please refer to the message 1 in UE-SE-B-2-AKA.

24. 100 Trying P-CSCF -> NUT

SIP/2.0 100 Trying

Via: SIP/2.0/UDP [3ffe:501:ffff:1000::1000]:1357;branch=z9hG4bK74bf9

From: <sip:UEa1_public_1@under.test.com>;tag=9fxced76sl

To: <sip:UEa2_public_1@under.test.com>

Call-ID: 3848276298220188511@under.test.com



CSeq: 1 INVITE
Content-Length: 0

25. <Wait 7 sec to check stoping re-transmission.>

As regards the message 26-29, please refer to the message 3-6 in UE-SE-B-2-AKA.

30. 100 Trying P-CSCF -> NUT
SIP/2.0 100 Trying
Via: SIP/2.0/UDP [3ffe:501:ffff:1000::1000]:1357;branch=z9hG4bK74bf11
From: <sip:UEa1_public_1@under.test.com>;tag=9fxced76sl
To: <sip:UEa2_public_1@under.test.com>;tag=314259
Call-ID: 3848276298220188511@under.test.com
CSeq: 2 BYE
Content-Length: 0

As regards the message 31, please refer to the message 6 in UE-SE-B-2-AKA.
As regards the message 32, please refer to the message 30 in this.

33. <Wait 4 sec to check sending re-transmission.>

As regards the message 34, please refer to the message 7 in UE-SE-B-2-AKA.

[OBSERVABLE RESULTS]

*1: 7 REGISTER for authentication from NUT to P-CSCF.

See generic_Auth_REGISTER

*2: 16 NOTIFY 200 OK from NUT to P-CSCF.

See generic_200-NOTIFY

*3: 23 INVITE from NUT to P-CSCF.

See generic_INVITE



*4: 25 Wait 7 sec to check stoping re-transmission

In the "Proceeding" state, the client transaction SHOULD NOT retransmit the request any longer. [RFC3261-17.1-17]

*5: 28 ACK from NUT to P-CSCF.

See generic_ACK

4.7.2 UE-RR-B-2-AKA - Receiving 181 response (Call transfer by S-CSCFa2 to UEa2')

[NAME]

UE-RR-B-2-AKA - Receiving 181 response (Call transfer by S-CSCFa2 to UEa2')

[TARGET]

IMS User Equipment (NUT)

[PURPOSE]

To verify that the UEa1 properly process a 181 (Call is Being Forwarded) response, and verify that the UEa1 properly creates an ACK request and a 200 (OK) response to BYE.

[REFERENCE]

TS24.229 A.2.1.4.1

[REQUIREMENT]

NONE

[PARAMETER(NUT)]

public-user-id	:	sip:UEa1_public_1@under.test.com
private-user-id	:	UEa1_private@under.test.com
contact_URI	:	sip:UEa1_public_1@node.under.test.com
HOMENETWORK Domain	:	sip:under.test.com



[PARAMETER(TESTER)]

public-user-id : sip:UEa2_public_1@under.test.com
P-CSCFa1 : sip:p.a1.under.test.com

[ADDRESS]

UEa1(NUT) : 3ffe:501:ffff:1000::1000
Router(R1) : 3ffe:501:ffff:1000::1
P-CSCFa1 : 3ffe:501:ffff:100::10
I-CSCFa1 : 3ffe:501:ffff:100::20
S-CSCFa1 : 3ffe:501:ffff:100::30
DNS : 3ffe:501:ffff:100::40
DHCP : 3ffe:501:ffff:100::50

UEa2 : 3ffe:501:ffff:2000::1000
UEa2' : 3ffe:501:ffff:2000::1001
P-CSCFa2 : 3ffe:501:ffff:200::10
I-CSCFa2 : 3ffe:501:ffff:200::20
S-CSCFa2 : 3ffe:501:ffff:200::30

[TOPOLOGY]

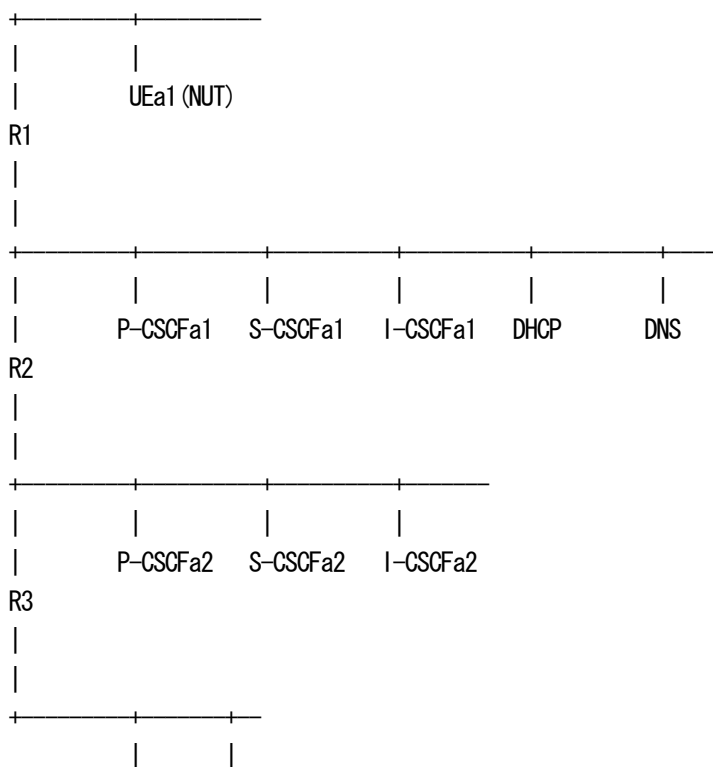

UEa2 UEa2'

[INITIALIZATION]

UEa1(NUT) must be registered with the tester by executing the scenario "UE-INI-B-1-AKA".

For details of "UE-INI-B-1-AKA", refer to the profile "UE-RG-B-1-AKA".

[PROCEDURE]

Home Network

(NUT)

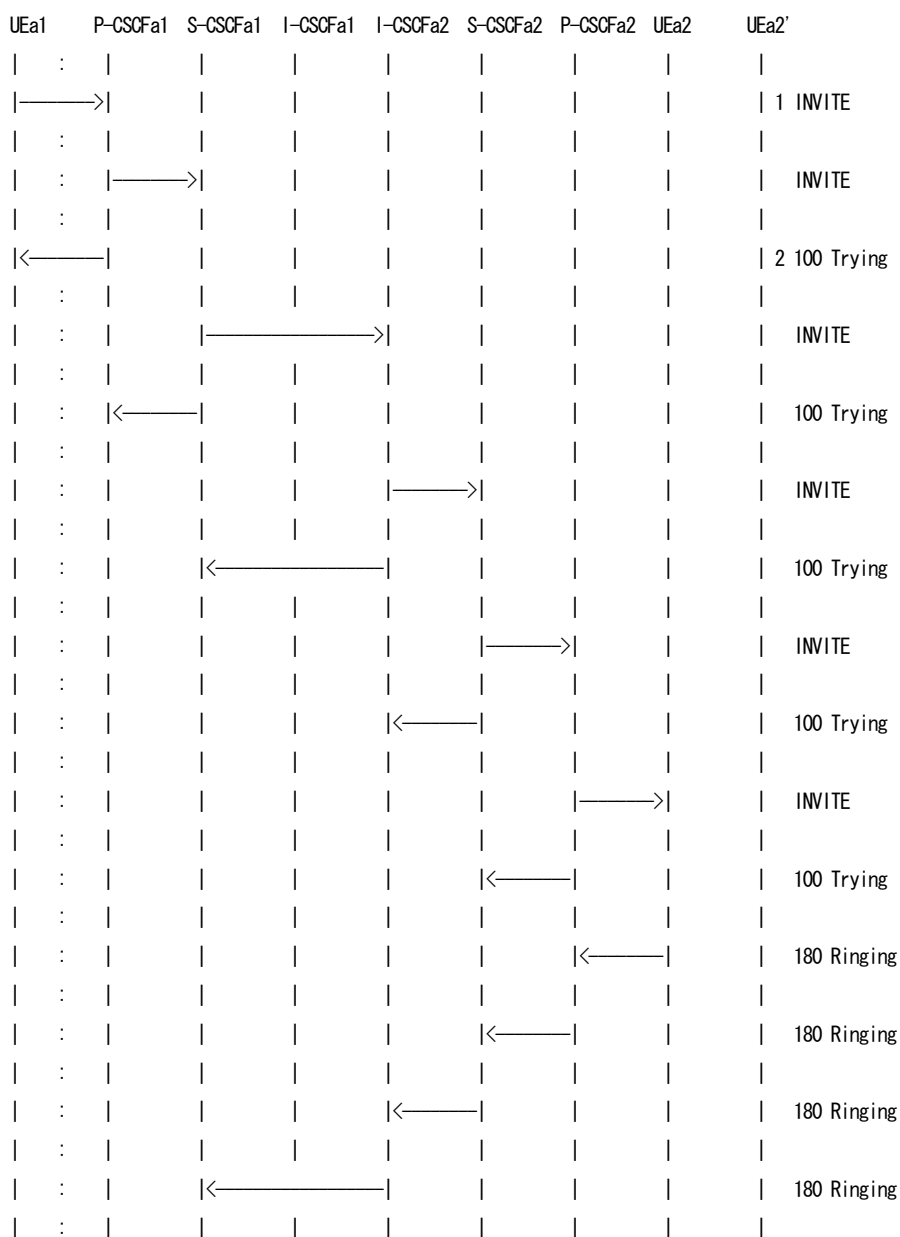

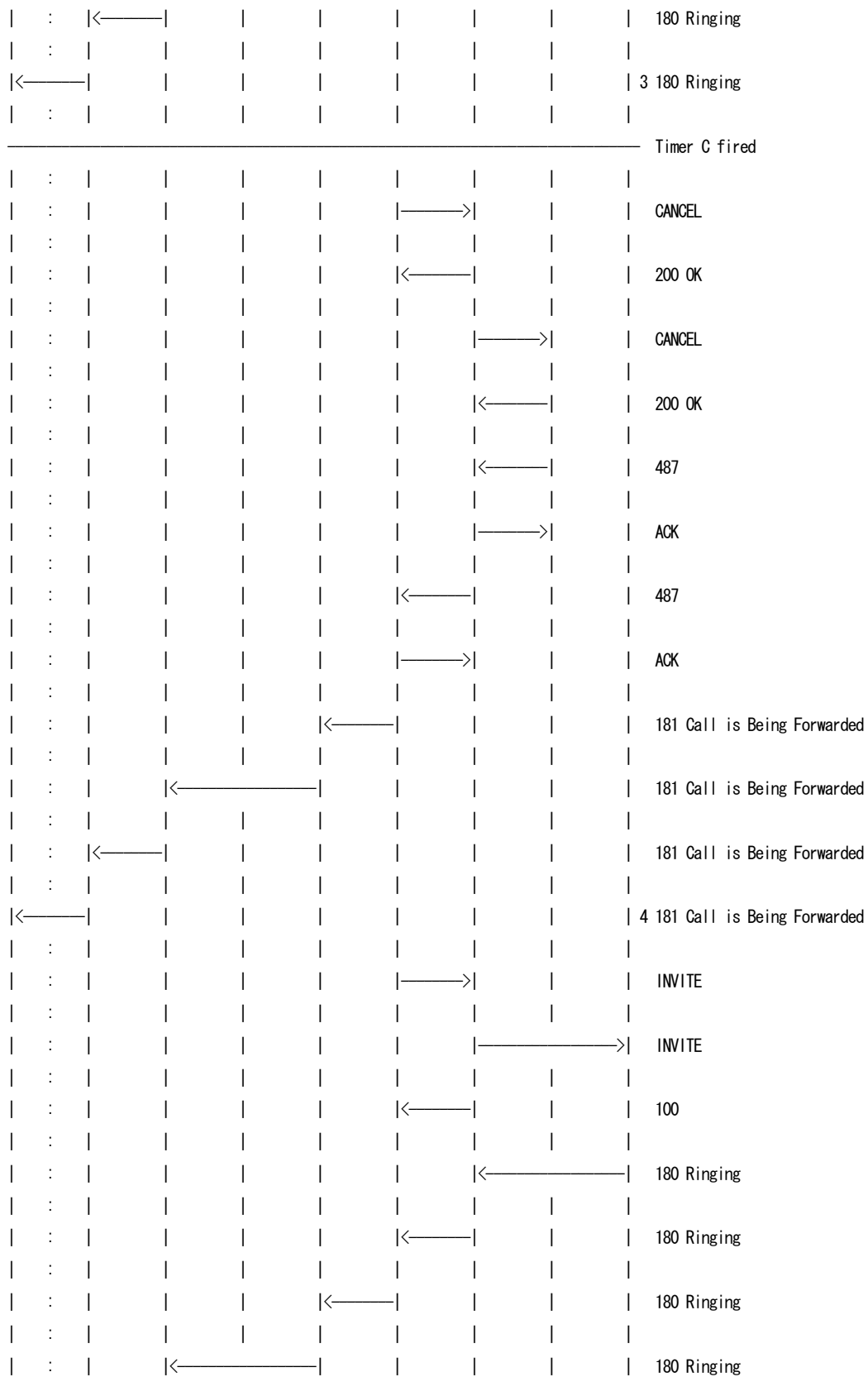

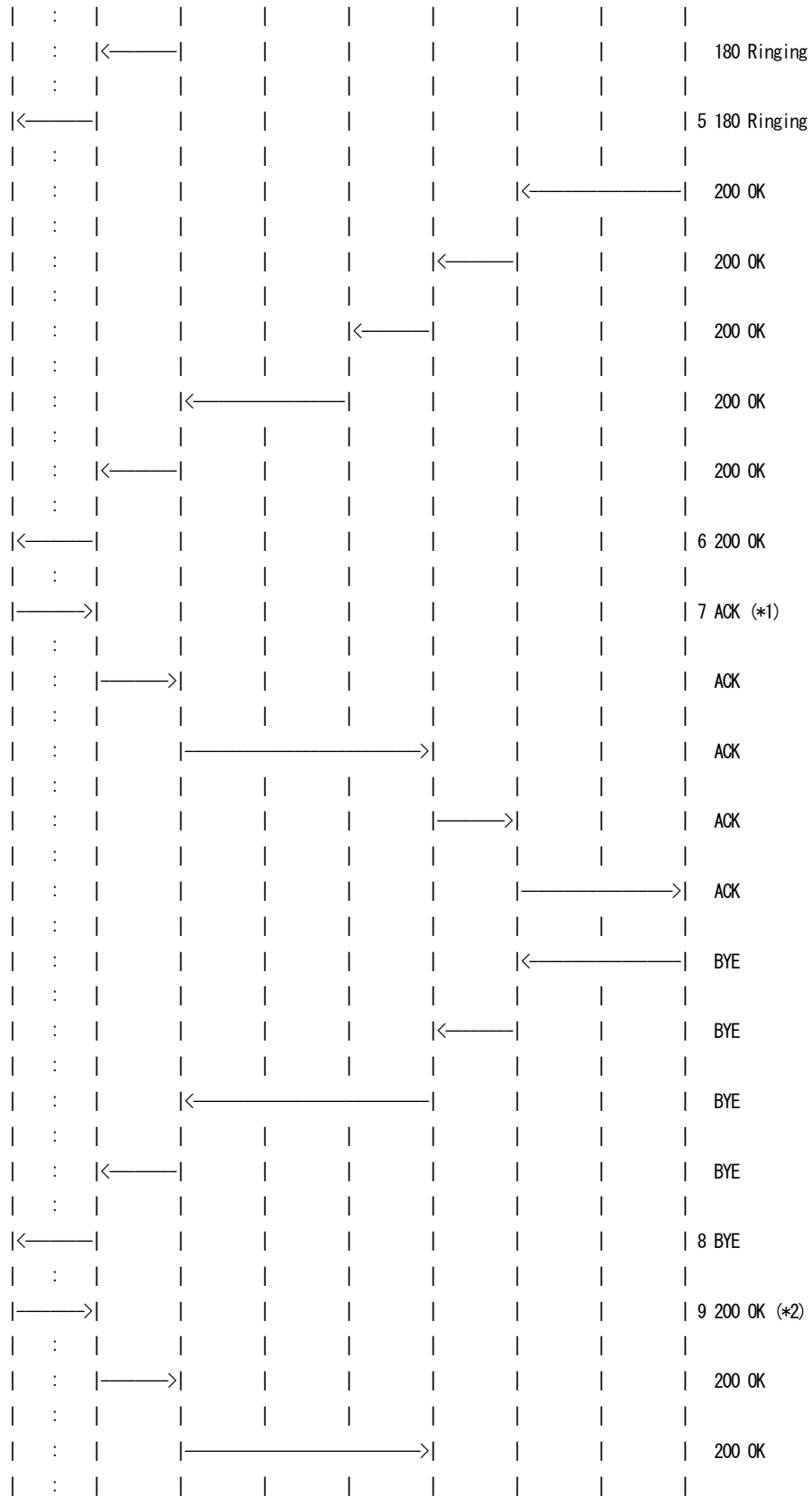



	:									200 OK
	:									
	:									200 OK
	:									

- 1 NUT sends INVITE
- 2 NUT receives 100 Trying
- 3 NUT receives 180 Ringing from UEa2
- 4 NUT receives 181 Call Is Being Forwarded
- 5 NUT receives 180 Ringing from UEa2'
- 6 NUT receives 200 OK
- 7 NUT sends ACK
- 8 NUT receives BYE
- 9 NUT sends 200 OK

=== Message example ===

As regards the message 1-2, please refer to the message 1-2 in UE-SE-B-1-AKA.

3. 180 Ringing P-CSCF -> NUT

SIP/2.0 180 Ringing

Via: SIP/2.0/UDP [3ffe:501:ffff:1000::1000]:1357;branch=z9hG4bK74bf9

From: <sip:UEa1_public_1@under.test.com>;tag=9fxced76sl

To: <sip:UEa2_public_1@under.test.com>;tag=314259

Call-ID: 3848276298220188511@under.test.com

CSeq: 1 INVITE

Content-Length: 0

4. 181 Call Is Being Forwarded P-CSCF -> NUT

SIP/2.0 181 Call Is Being Forwarded

Via: SIP/2.0/UDP [3ffe:501:ffff:1000::1000]:1357;branch=z9hG4bK74bf9

From: <sip:UEa1_public_1@under.test.com>;tag=9fxced76sl

To: <sip:UEa2_public_1@under.test.com>

Call-ID: 3848276298220188511@under.test.com

CSeq: 1 INVITE

Content-Length: 0

5. 180 Ringing P-CSCF -> NUT

SIP/2.0 180 Ringing



Via: SIP/2.0/UDP [3ffe:501:ffff:1000::1000]:1357;branch=z9hG4bK74bf9
From: <sip:UEa1_public_1@under.test.com>;tag=9fxced76sl
To: <sip:UEa2_public_1@under.test.com>;tag=314260
Call-ID: 3848276298220188511@under.test.com
CSeq: 1 INVITE
Content-Length: 0

6. 200 OK P-CSCF -> NUT

SIP/2.0 200 OK

Via: SIP/2.0/UDP [3ffe:501:ffff:1000::1000]:1357;branch=z9hG4bK74bf9
Record-Route: <sip:p.a2.under.test.com;lr>,<sip:s.a2.under.test.com;lr>,
<sip:s.a1.under.test.com;lr>,<sip:p.a1.under.test.com:10001;lr>
From: <sip:UEa1_public_1@under.test.com>;tag=9fxced76sl
To: <sip:UEa2_public_1@under.test.com>;tag=314260
Call-ID: 3848276298220188511@under.test.com
CSeq: 1 INVITE
Contact: <sip:UEa2_public_1@3nodea2.under.test.com:22222>
Supported:
Allow: INVITE,ACK,CANCEL,OPTIONS,BYE
Allow-Events: reg
Content-Type: application/sdp
Content-Length: 153

v=0

o=UEa2 2890844527 2890844527 IN IP6 3nodea2.under.test.com

s=-

c=IN IP6 3nodea2.under.test.com

t=0 0

m=audio 3456 RTP/AVP 0

b=AS:75

a=rtpmap:0 PCMU/8000

7. ACK NUT -> P-CSCF

ACK sip:UEa2_public_1@3nodea2.under.test.com:22222 SIP/2.0

Via: SIP/2.0/UDP [3ffe:501:ffff:1000::1000]:1357;branch=z9hG4bK74bf10

Route: <sip:p.a1.under.test.com:10001;lr>,<sip:s.a1.under.test.com;lr>,
<sip:s.a2.under.test.com;lr>,<sip:p.a2.under.test.com;lr>

Max-Forwards: 70

From: <sip:UEa1_public_1@under.test.com>;tag=9fxced76sl

To: <sip:UEa2_public_1@under.test.com>;tag=314260

Call-ID: 3848276298220188511@under.test.com



CSeq: 1 ACK
Content-Length: 0

8. BYE P-CSCF -> NUT

BYE sip:UEa1_public_1@node.under.test.com:1357 SIP/2.0
Via: SIP/2.0/UDP p.a1.under.test.com:10001;branch=z9hG4bK431e418c501,
SIP/2.0/UDP s.a1.under.test.com;branch=z9hG4bKnashdsa2.3;received=3ffe:501:ffff:100::30,
SIP/2.0/UDP s.a2.under.test.com;branch=z9hG4bK721e418c9.1;received=3ffe:501:ffff:200::30,
SIP/2.0/UDP p.a2.under.test.com;branch=z9hG4bKnaghds30;received=3ffe:501:ffff:200::10,
SIP/2.0/UDP [3ffe:501:ffff:2000::1001];22222;branch=z9hG4bKnashdsb3
Max-Forwards: 66
From: <sip:UEa2_public_1@under.test.com>;tag=314260
To: <sip:UEa1_public_1@under.test.com>;tag=9fxced76sl
Call-ID: 3848276298220188511@under.test.com
CSeq: 2 BYE
Content-Length: 0

9. 200 OK NUT -> P-CSCF

SIP/2.0 200 OK
Via: SIP/2.0/UDP p.a1.under.test.com:10001;branch=z9hG4bK431e418c501;
received=3ffe:501:ffff:100::10,SIP/2.0/UDP s.a1.under.test.com;branch=z9hG4bKnashdsa2.3;
received=3ffe:501:ffff:100::30,SIP/2.0/UDP s.a2.under.test.com;branch=z9hG4bK721e418c9.1;
received=3ffe:501:ffff:200::30,SIP/2.0/UDP p.a2.under.test.com;branch=z9hG4bKnaghds30;
received=3ffe:501:ffff:200::10,SIP/2.0/UDP [3ffe:501:ffff:2000::1001];22222;branch=z9hG4bKnashdsb3
From: <sip:UEa2_public_1@under.test.com>;tag=314260
To: <sip:UEa1_public_1@under.test.com>;tag=9fxced76sl
Call-ID: 3848276298220188511@under.test.com
CSeq: 2 BYE
Content-Length: 0

[OBSERVABLE RESULTS]

*1: 4 181 Call is Being Forwarded from NUT to P-CSCF.

See generic_180-INVITE

*2: 7 ACK from NUT to P-CSCF.

See generic_ACK



*3: 9 BYE 200 OK from NUT to P-CSCF.

See generic_200-BYE

4.7.3 UE-RR-B-3-AKA - Receiving 182 response (Request is queued by P-CSCFa2)

[NAME]

UE-RR-B-3-AKA - Receiving 182 response (Request is queued by P-CSCFa2)

[TARGET]

IMS User Equipment (NUT)

[PURPOSE]

To verify that the UEa1 properly process a 182 (Queued) response, and verify that the UEa1 properly creates an ACK request and a 200 (OK) response to BYE.

[REFERENCE]

TS24.229 A.2.1.4.1

[REQUIREMENT]

NONE

[PARAMETER(NUT)]

public-user-id : sip:UEa1_public_1@under.test.com
private-user-id : UEa1_private@under.test.com
contact_URI : sip:UEa1_public_1@node.under.test.com
HOMENETWORK Domain : sip:under.test.com

[PARAMETER(TESTER)]

public-user-id(UEa2) : sip:UEa2_public_1@under.test.com
P-CSCFa1 : sip:p.a1.under.test.com

[ADDRESS]

UEa1(NUT) : 3ffe:501:ffff:1000::1000



Router(R1)	:	3ffe:501:fff:1000::1
P-CSCFa1	:	3ffe:501:fff:100::10
I-CSCFa1	:	3ffe:501:fff:100::20
S-CSCFa1	:	3ffe:501:fff:100::30
DNS	:	3ffe:501:fff:100::40
DHCP	:	3ffe:501:fff:100::50
UEa2	:	3ffe:501:fff:2000::1000
P-CSCFa2	:	3ffe:501:fff:200::10
I-CSCFa2	:	3ffe:501:fff:200::20
S-CSCFa2	:	3ffe:501:fff:200::30

[TOPOLOGY]

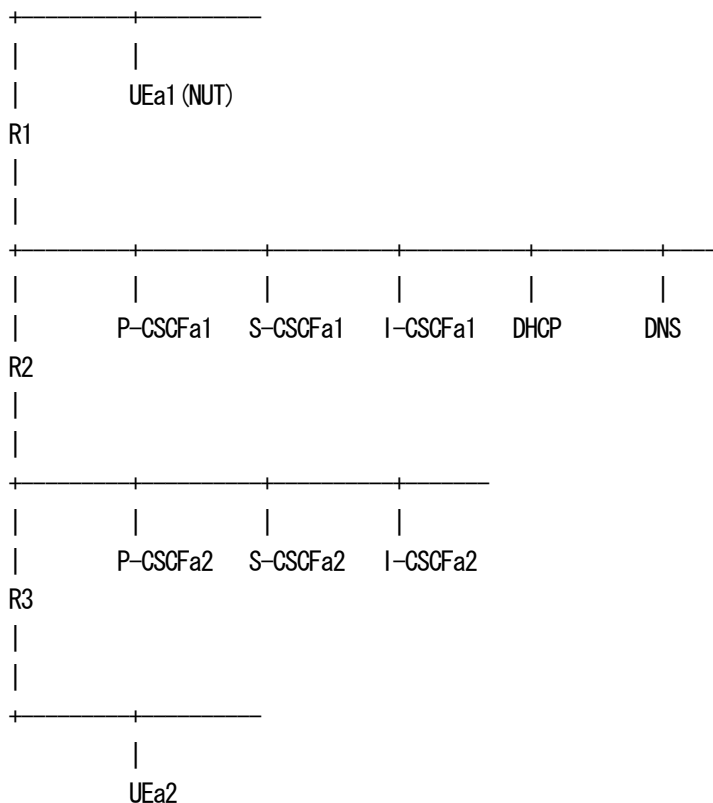

[INITIALIZATION]

UEa1(NUT) must be registered with the tester by executing the scenario "UE-INI-B-1-AKA".
For details of "UE-INI-B-1-AKA", refer to the profile "UE-RG-B-1-AKA".

[PROCEDURE]

Home Network

(NUT)

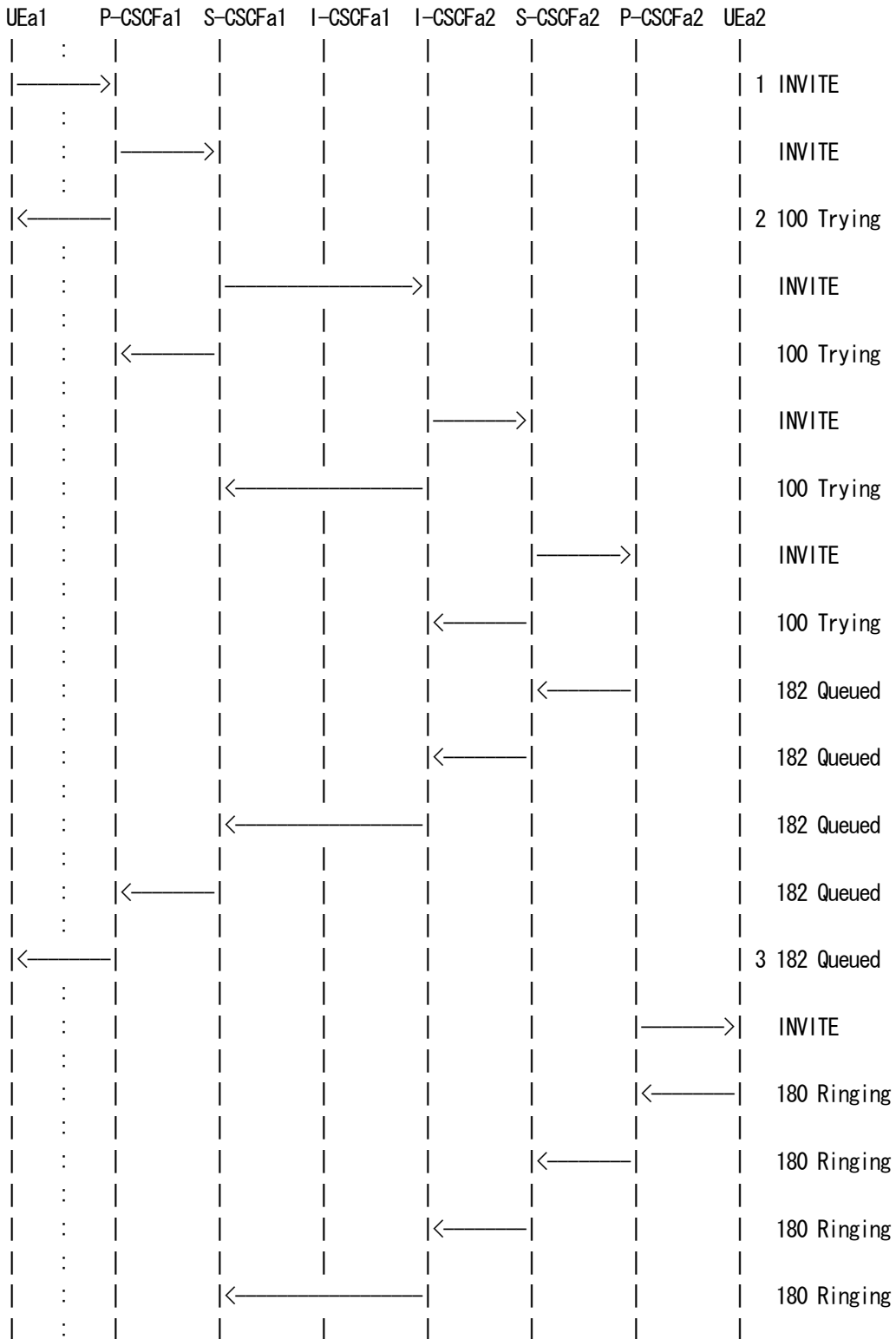

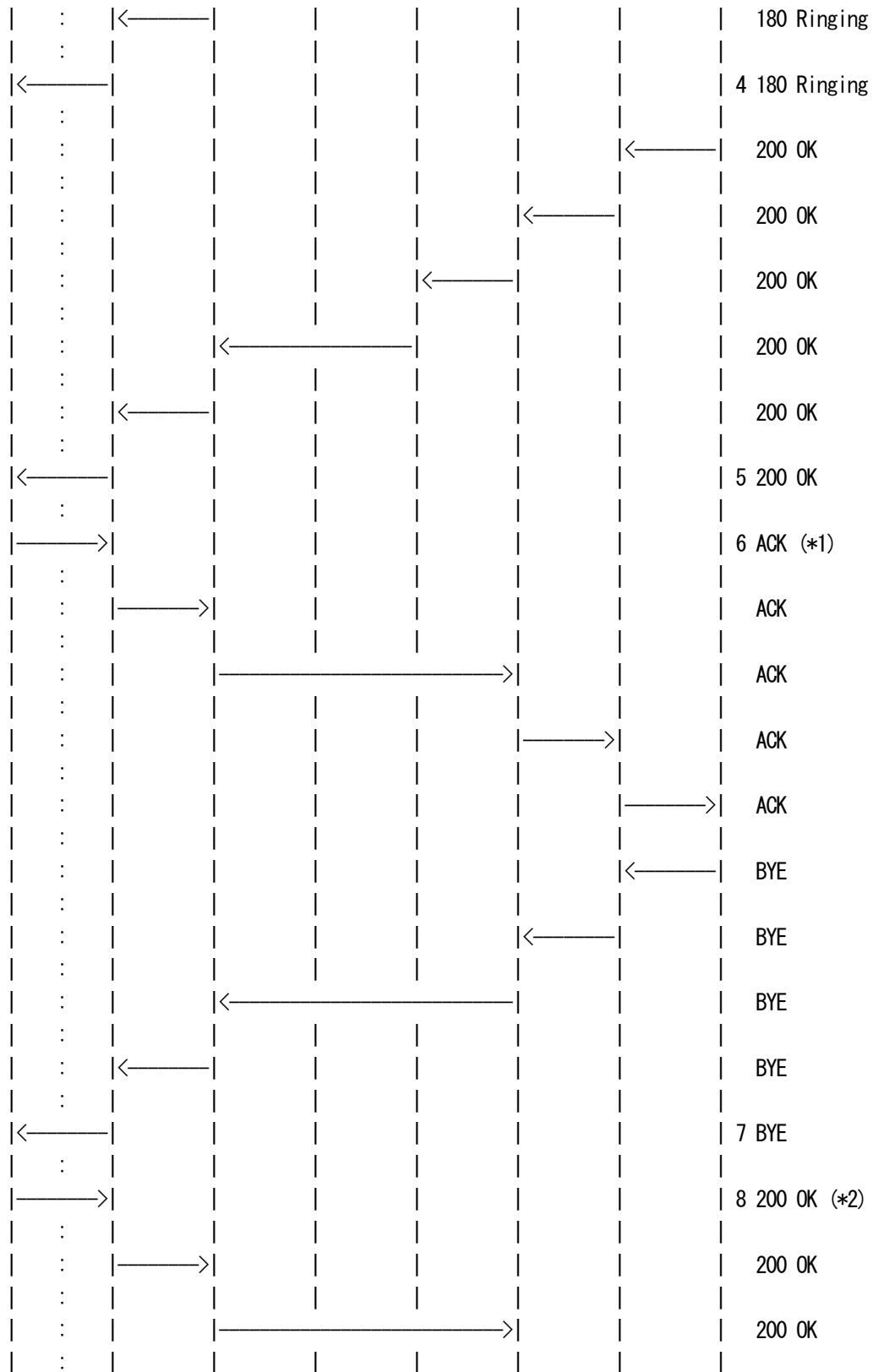

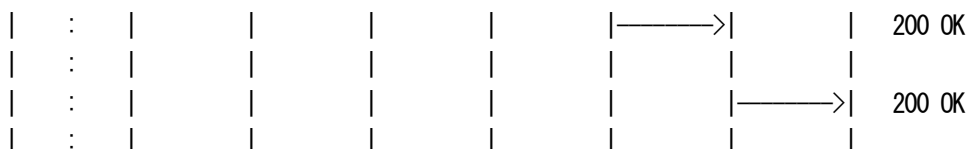

- 1 NUT sends INVITE
- 2 NUT receives 100 Trying
- 3 NUT receives 182 Queued
- 4 NUT receives 180 Ringing
- 5 NUT receives 200 OK
- 6 NUT sends ACK
- 7 NUT receives BYE
- 8 NUT sends 200 OK

=== Message example ===

As regards the message 1-2, please refer to the message 1-2 in UE-SE-B-1-AKA.

3. 182 Queued P-CSCF -> NUT

SIP/2.0 182 Queued

Via: SIP/2.0/UDP [3ffe:501:ffff:1000::1000]:1357;branch=z9hG4bK74bf9

From: <sip:UEa1_public_1@under.test.com>;tag=9fxced76sl

To: <sip:UEa2_public_1@under.test.com>

Call-ID: 3848276298220188511@under.test.com

CSeq: 1 INVITE

Content-Length: 0

As regards the message 4-8, please refer to the message 3-7 in UE-SE-B-1-AKA.

[OBSERVABLE RESULTS]

*1: 6 ACK from NUT to P-CSCF.

See generic_ACK

*2: 8 BYE 200 OK from NUT to P-CSCF.

See generic_200-BYE



4.7.4 UE-RR-B-4-AKA - Receiving 183 response

[NAME]

UE-RR-B-4-AKA - Receiving 183 response

[TARGET]

IMS User Equipment (NUT)

[PURPOSE]

To verify that the UEa1 properly process a 183 (Session Progress) response, and verify that the UEa1 properly process a 200 (OK) response and creates an ACK request and a 200 (OK) response to BYE.

[REFERENCE]

TS24.229 A.2.1.4.1

RFC3261 8.1.3.2

[REQUIREMENT]

NONE

[PARAMETER(NUT)]

public-user-id : sip:UEa1_public_1@under.test.com
private-user-id : UEa1_private@under.test.com
contact_URI : sip:UEa1_public_1@node.under.test.com
HOMENETWORK Domain : sip:under.test.com

[PARAMETER(TESTER)]

public-user-id(UEa2) : sip:UEa2_public_1@under.test.com
P-CSCFa1 : sip:p.a1.under.test.com

[ADDRESS]

UEa1(NUT) : 3ffe:501:ffff:1000::1000
Router(R1) : 3ffe:501:ffff:1000::1
P-CSCFa1 : 3ffe:501:ffff:100::10
I-CSCFa1 : 3ffe:501:ffff:100::20



S-CSCFa1	:	3ffe:501:fff:100::30
DNS	:	3ffe:501:fff:100::40
DHCP	:	3ffe:501:fff:100::50
UEa2	:	3ffe:501:fff:2000::1000
P-CSCFa2	:	3ffe:501:fff:200::10
I-CSCFa2	:	3ffe:501:fff:200::20
S-CSCFa2	:	3ffe:501:fff:200::30

[TOPOLOGY]

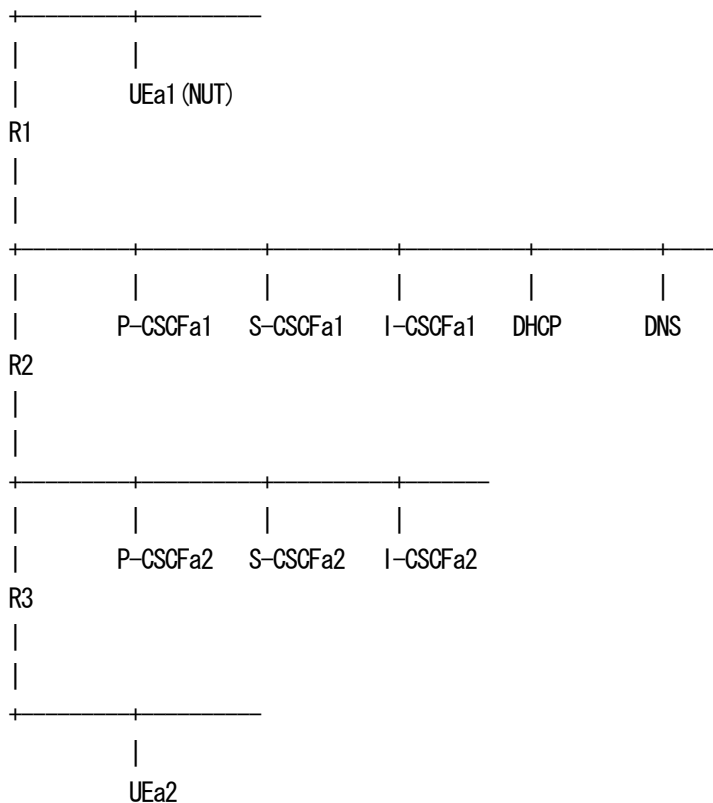

[INITIALIZATION]

UEa1(NUT) must be registered with the tester by executing the scenario "UE-INI-B-1-AKA".
For details of "UE-INI-B-1-AKA", refer to the profile "UE-RG-B-1-AKA".

[PROCEDURE]

Home Network

(NUT)

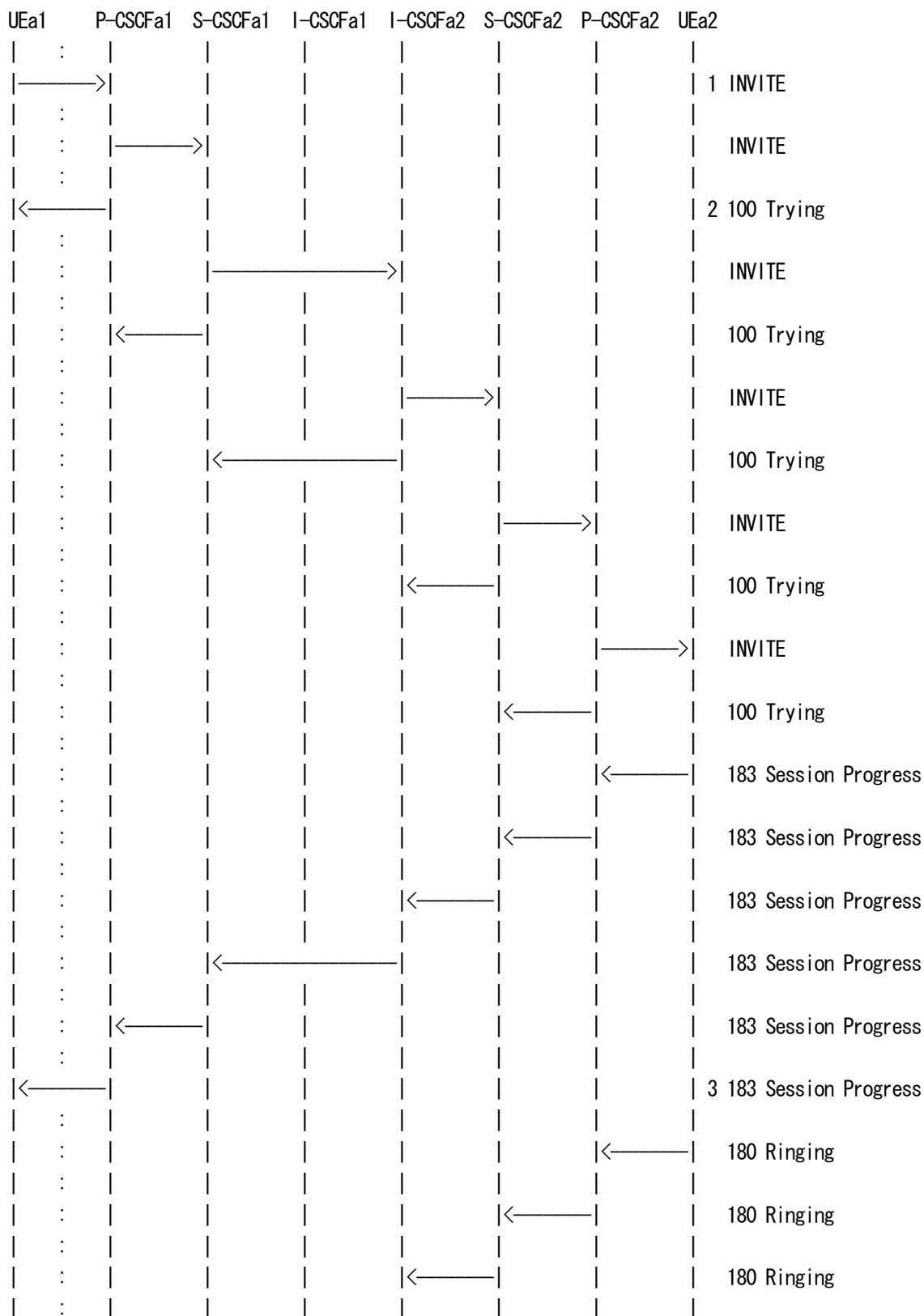

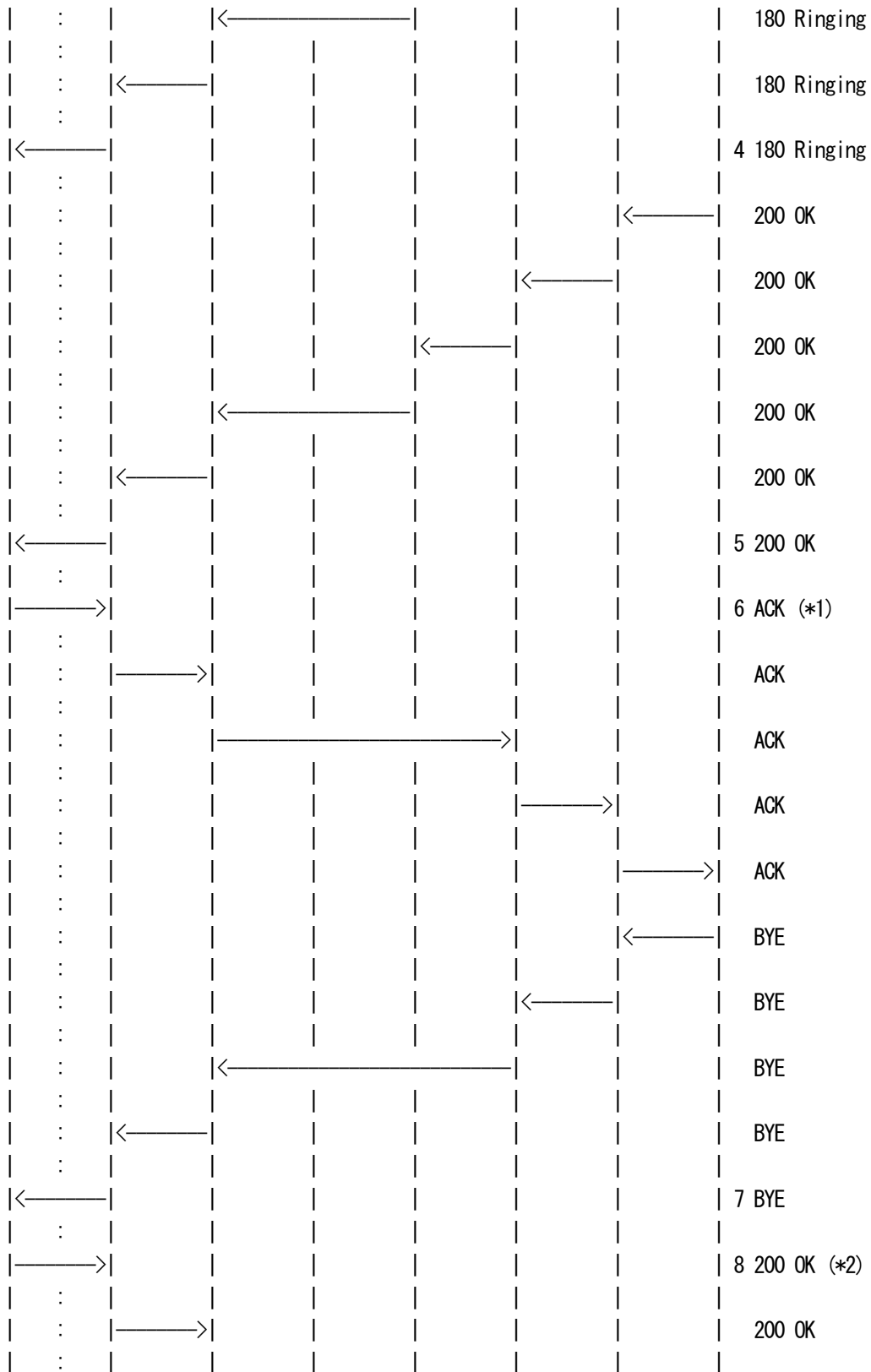

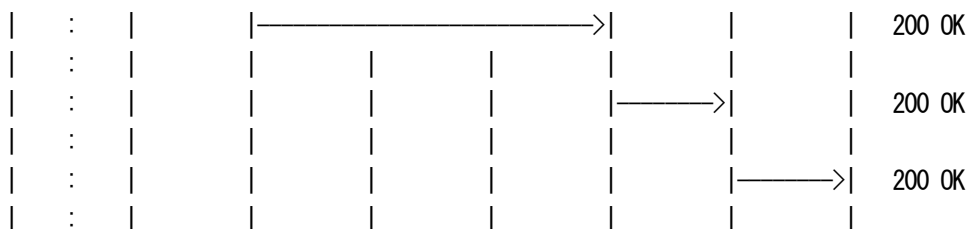

- 1 NUT sends INVITE
- 2 NUT receives 100 Trying
- 3 NUT receives 183 Session Progress
- 4 NUT receives 180 Ringing
- 5 NUT receives 200 OK
- 6 NUT sends ACK
- 7 NUT receives BYE
- 8 NUT sends 200 OK

=== Message example ===

As regards the message 1-2, please refer to the message 1-2 in UE-SE-B-1-AKA.

3. 183 Session Progress P-CSCF -> NUT
SIP/2.0 183 Session Progress
Via: SIP/2.0/UDP [3ffe:501:ffff:1000::1000]:1357;branch=z9hG4bK74bf9
From: <sip:UEa1_public_1@under.test.com>;tag=9fxced76sl
To: <sip:UEa2_public_1@under.test.com>;tag=314259
Call-ID: 3848276298220188511@under.test.com
CSeq: 1 INVITE
Content-Length: 0

As regards the message 4-8, please refer to the message 3-7 in UE-SE-B-1-AKA.

[OBSERVABLE RESULTS]

*1: 6 ACK from NUT to P-CSCF.

See generic_ACK

*2: 8 BYE 200 from NUT to P-CSCF.



See generic_200-BYE

4.7.5 UE-RR-B-5-AKA - Receiving 202 response

[NAME]

UE-RR-B-5-AKA - Receiving 202 response

[TARGET]

IMS User Equipment (NUT)

[PURPOSE]

To verify that the UEa1 properly process a 202 (Accepted) response, and verify that the UEa1 properly creates a 200 (OK) response to NOTIFY.

[REFERENCE]

TS24.229 A.2.1.4.1

[REQUIREMENT]

NONE

[PARAMETER(NUT)]

public-user-id : sip:UEa1_public_1@under.test.com
private-user-id : UEa1_private@under.test.com
contact_URI : sip:UEa1_public_1@node.under.test.com
HOMENETWORK Domain : sip:under.test.com

[PARAMETER(TESTER)]

P-CSCFa1 : sip:p.a1.under.test.com
S-CSCFa1 : sip:s.a1.under.test.com

[ADDRESS]

UEa1(NUT) : 3ffe:501:ffff:1000::1000
Router(R1) : 3ffe:501:ffff:1000::1
P-CSCFa1 : 3ffe:501:ffff:100::10
I-CSCFa1 : 3ffe:501:ffff:100::20



```

S-CSCFa1      :      3ffe:501:fff:100::30
DNS           :      3ffe:501:fff:100::40
DHCP         :      3ffe:501:fff:100::50
  
```

[TOPOLOGY]

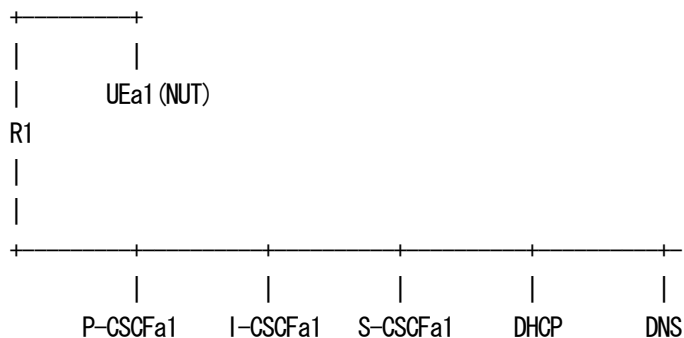

[INITIALIZATION]

Set up IP Address by A or B.

A. Router Advertisement

B. DHCPv6

(NUT)

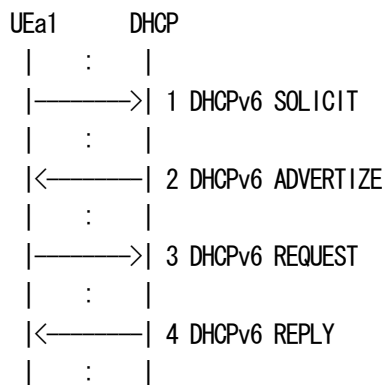

[PROCEDURE]

Home Network

(NUT)

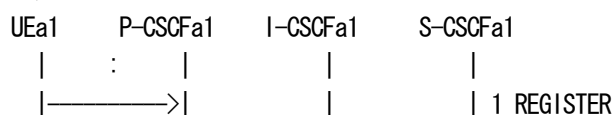

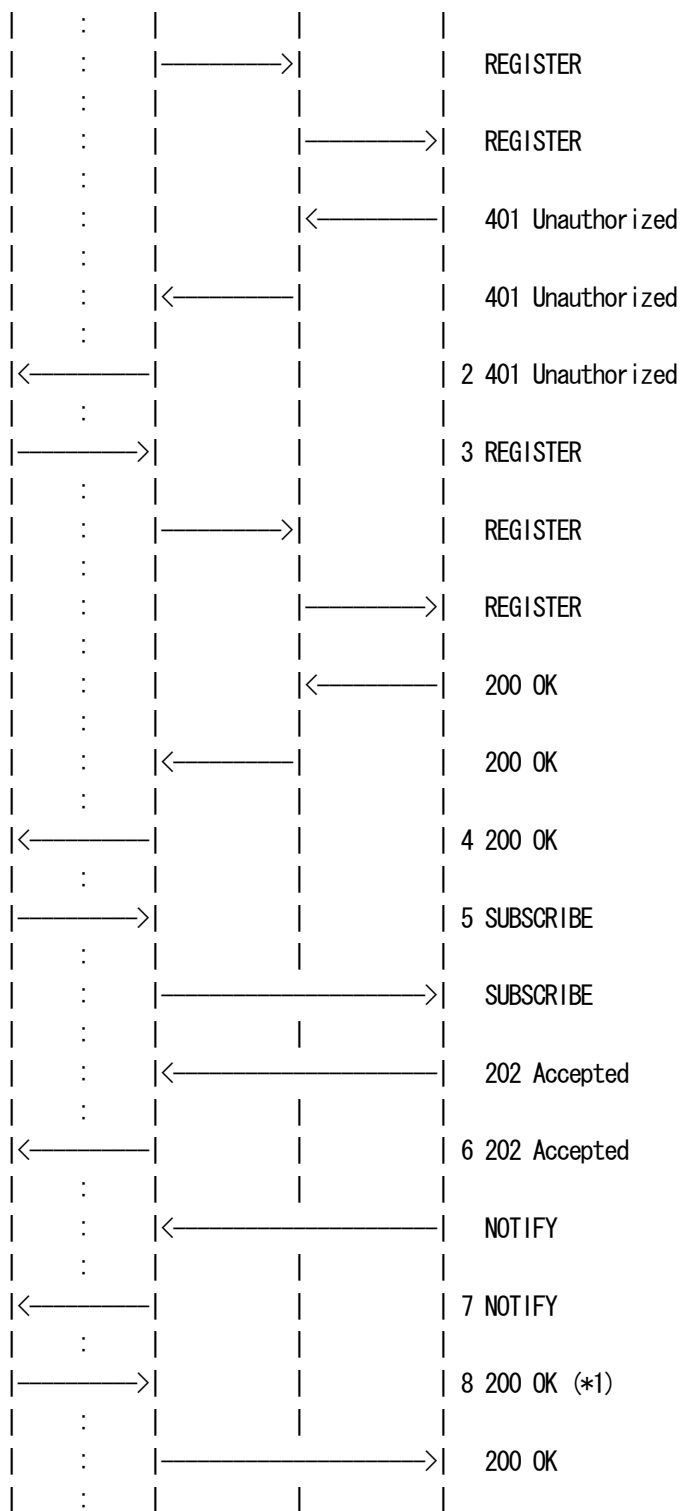

1 NUT sends REGISTER
 2 NUT receives 401 Unauthorized



- 3 NUT sends REGISTER for authentication
- 4 NUT receives 200 OK
- 5 NUT sends SUBSCRIBE
- 6 NUT receives 202 Accepted
- 7 NUT receives NOTIFY
- 8 NUT sends 200 OK

=== Message example ===

As regards the message 1-5, please refer to the message 1-5 in UE-RG-B-1-AKA.

```
6. 202 Accepted P-CSCF -> NUT
SIP/2.0 202 Accepted
Via: SIP/2.0/UDP [3ffe:501:ffff:1000::1000]:1357;branch=z9hG4bKnashdsa1
Record-Route: <sip:p.a1.under.test.com:10001;lr>
From: <sip:UEa1_public_1@under.test.com>;tag=31415
To: <sip:UEa1_public_1@under.test.com>;tag=151170
Call-ID: b89rjhnedlrfflsj40a222@under.test.com
CSeq: 1 SUBSCRIBE
Contact: <sip:s.a1.under.test.com>
Allow-Events: reg
Expires: 600000
Content-Length: 0
```

As regards the message 7-8, please refer to the message 7-8 in UE-RG-B-1-AKA.

[OBSERVABLE RESULTS]

*1: 8 NOTIFY 200 OK from NUT to P-CSCF.

See generic_200-NOTIFY

4.7.6 UE-RR-B-6-AKA - Receiving 400 response

[NAME]

UE-RR-B-6-AKA - Receiving 400 response



[TARGET]

IMS User Equipment (NUT)

[PURPOSE]

To verify that the UEa1 properly process a 400 (Bad Request) response, and verify that the UEa1 properly creates an ACK request.

[REFERENCE]

TS24.229 A.2.1.4.1

[REQUIREMENT]

NONE

[PARAMETER(NUT)]

public-user-id : sip:UEa1_public_1@under.test.com
private-user-id : UEa1_private@under.test.com
contact_URI : sip:UEa1_public_1@node.under.test.com
HOMENETWORK Domain : sip:under.test.com

[PARAMETER(TESTER)]

public-user-id(UEa2) : sip:UEa2_public_1@under.test.com
P-CSCFa1 : sip:p.a1.under.test.com

[ADDRESS]

UEa1(NUT) : 3ffe:501:ffff:1000::1000
Router(R1) : 3ffe:501:ffff:1000::1
P-CSCFa1 : 3ffe:501:ffff:100::10
I-CSCFa1 : 3ffe:501:ffff:100::20
S-CSCFa1 : 3ffe:501:ffff:100::30
DNS : 3ffe:501:ffff:100::40
DHCP : 3ffe:501:ffff:100::50

UEa2 : 3ffe:501:ffff:2000::1000
P-CSCFa2 : 3ffe:501:ffff:200::10
I-CSCFa2 : 3ffe:501:ffff:200::20
S-CSCFa2 : 3ffe:501:ffff:200::30

[TOPOLOGY]

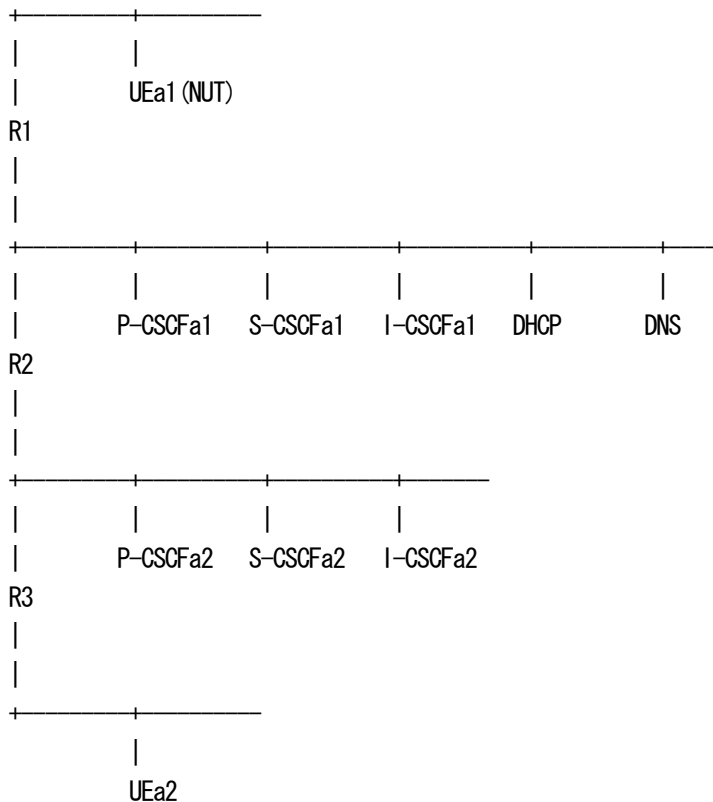

[INITIALIZATION]

UEa1(NUT) must be registered with the tester by executing the scenario "UE-INI-B-1-AKA".
 For details of "UE-INI-B-1-AKA", refer to the profile "UE-RG-B-1-AKA".

[PROCEDURE]

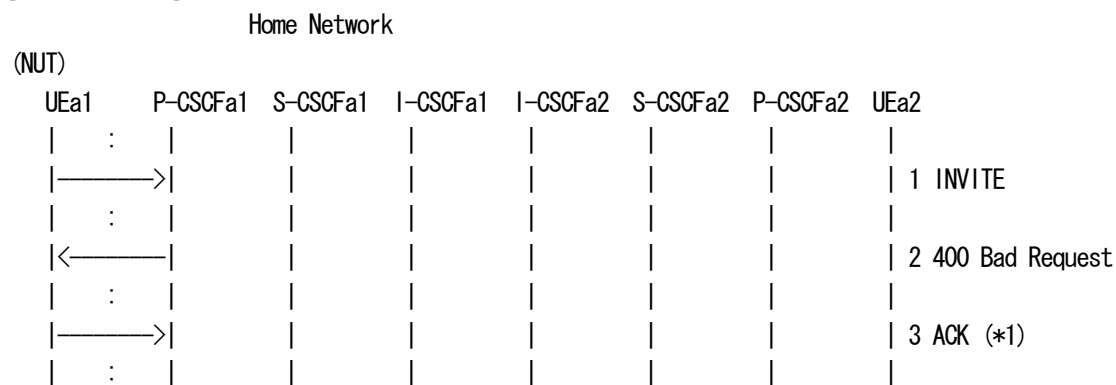

1 NUT sends INVITE



2 NUT receives 400 Bad Request
3 NUT sends ACK

=== Message example ===

As regards the message 1, please refer to the message 1 in UE-SE-B-1-AKA.

2. 400 Bad Request P-CSCF -> NUT

SIP/2.0 400 Bad Request

Via: SIP/2.0/UDP [3ffe:501:ffff:1000::1000]:1357;branch=z9hG4bK74bf9

From: <sip:UEa1_public_1@under.test.com>;tag=9fxced76sl

To: <sip:UEa2_public_1@under.test.com>;tag=314259

Call-ID: 3848276298220188511@under.test.com

CSeq: 1 INVITE

Content-Length: 0

3. ACK NUT -> P-CSCF

ACK sip:UEa2_public_1@under.test.com SIP/2.0

Via: SIP/2.0/UDP [3ffe:501:ffff:1000::1000]:1357;branch=z9hG4bK74bf9

Route: <sip:p.a1.under.test.com:10001;lr>,<sip:orig@s.a1.under.test.com;lr>

Max-Forwards: 70

From: <sip:UEa1_public_1@under.test.com>;tag=9fxced76sl

To: <sip:UEa2_public_1@under.test.com>;tag=314259

Call-ID: 3848276298220188511@under.test.com

CSeq: 1 ACK

Content-Length: 0

[OBSERVABLE RESULTS]

*1: 3 ACK from NUT to P-CSCF.

See generic_ACK-non2XX

4.7.7 UE-RR-B-7-AKA - Receiving 404 response

[NAME]

UE-RR-B-7-AKA - Receiving 404 response



[TARGET]

IMS User Equipment (NUT)

[PURPOSE]

To verify that the UEa1 properly process a 404 (Not Found) response, and verify that the UEa1 properly creates an ACK request.

[REFERENCE]

TS24.229 A.2.1.4.1

[REQUIREMENT]

NONE

[PARAMETER(NUT)]

public-user-id : sip:UEa1_public_1@under.test.com
private-user-id : UEa1_private@under.test.com
contact_URI : sip:UEa1_public_1@node.under.test.com
HOMENETWORK Domain : sip:under.test.com

[PARAMETER(TESTER)]

public-user-id(UEa2) : sip:UEa2_public_1@under.test.com
P-CSCFa1 : sip:p.a1.under.test.com

[ADDRESS]

UEa1(NUT) : 3ffe:501:fff:1000::1000
Router(R1) : 3ffe:501:fff:1000::1
P-CSCFa1 : 3ffe:501:fff:100::10
I-CSCFa1 : 3ffe:501:fff:100::20
S-CSCFa1 : 3ffe:501:fff:100::30
DNS : 3ffe:501:fff:100::40
DHCP : 3ffe:501:fff:100::50

UEa2 : 3ffe:501:fff:2000::1000
P-CSCFa2 : 3ffe:501:fff:200::10
I-CSCFa2 : 3ffe:501:fff:200::20
S-CSCFa2 : 3ffe:501:fff:200::30

[TOPOLOGY]

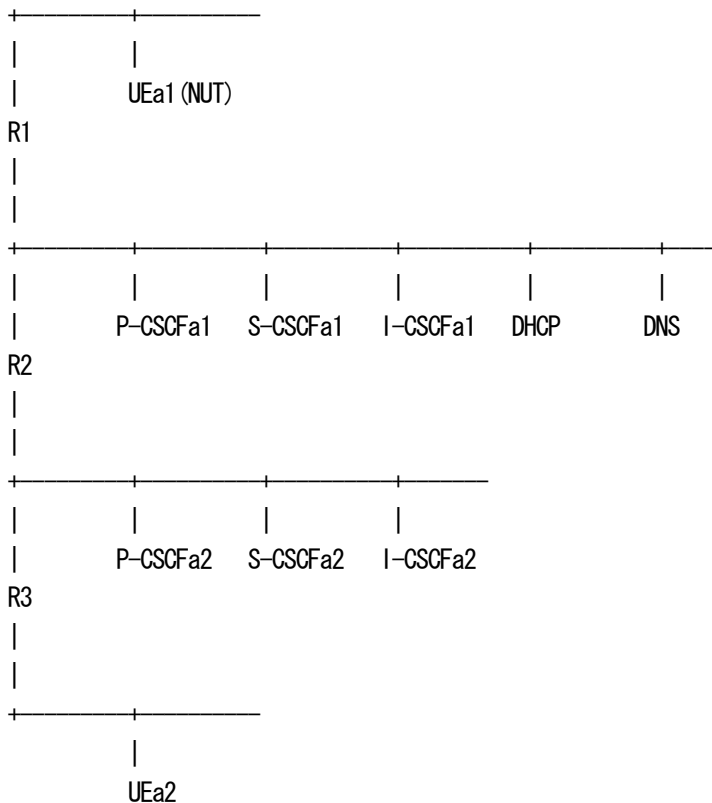

[INITIALIZATION]

UEa1(NUT) must be registered with the tester by executing the scenario "UE-INI-B-1-AKA".

For details of "UE-INI-B-1-AKA", refer to the profile "UE-RG-B-1-AKA".

[PROCEDURE]

Home Network

(NUT)

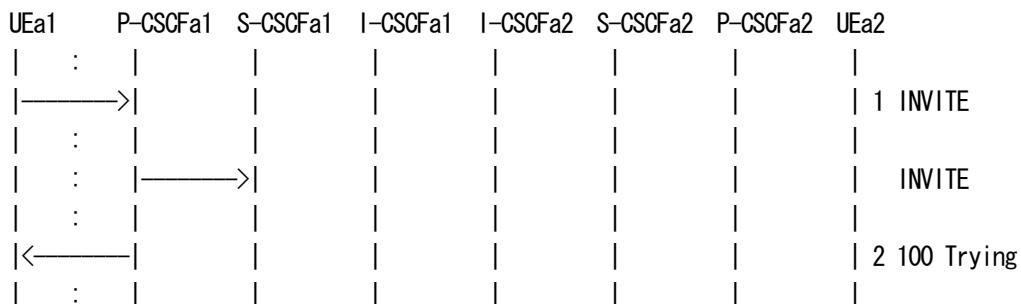

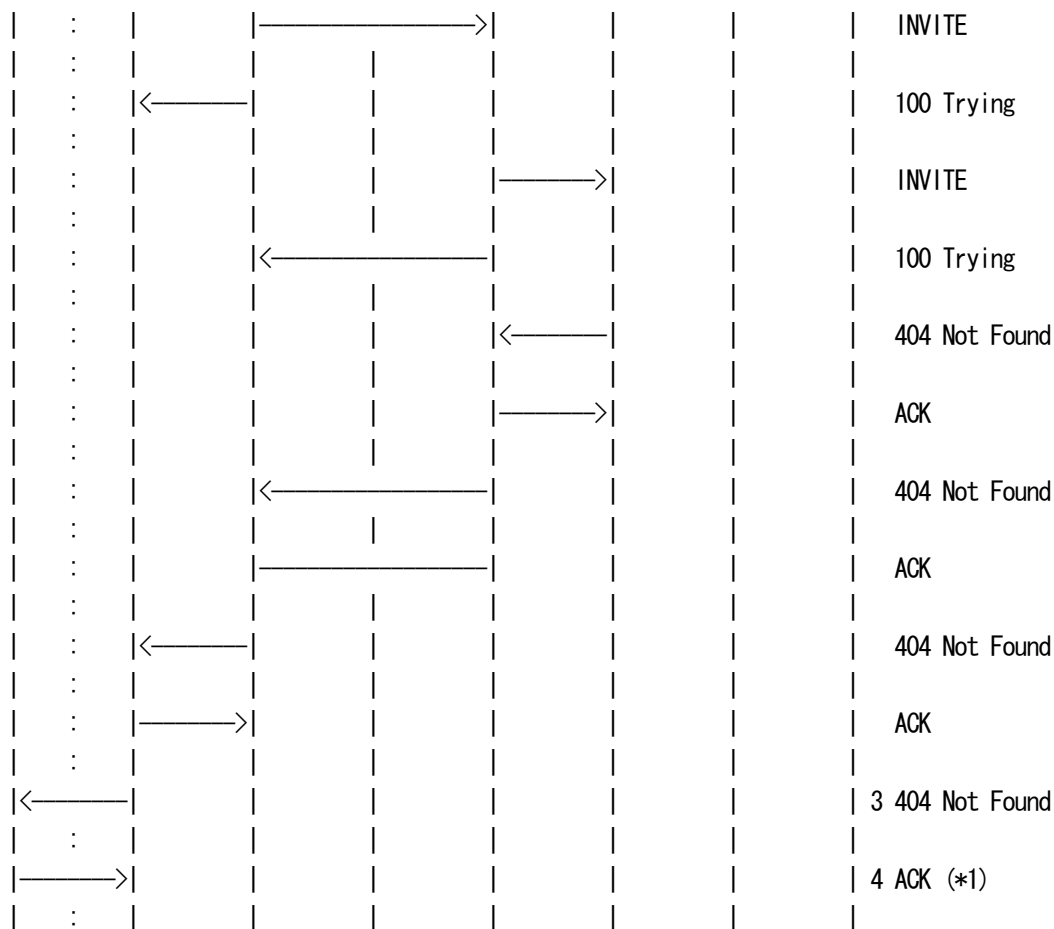

- 1 NUT sends INVITE
- 2 NUT receives 100 Trying
- 3 NUT receives 404 Not Found
- 4 NUT sends ACK

=== Message example ===

As regards the message 1-2, please refer to the message 1-2 in UE-SE-B-1-AKA.

3. 404 Not Found P-CSCF -> NUT

SIP/2.0 404 Not Found

Via: SIP/2.0/UDP [3ffe:501:ffff:1000::1000]:1357;branch=z9hG4bK74bf9

From: <sip:UEa1_public_1@under.test.com>;tag=9fxced76sl

To: <sip:UEa2_public_1@under.test.com>;tag=314259

Call-ID: 3848276298220188511@under.test.com

CSeq: 1 INVITE



Content-Length: 0

4. ACK NUT -> P-CSCF

ACK sip:UEa2_public_1@under.test.com SIP/2.0

Via: SIP/2.0/UDP [3ffe:501:ffff:1000::1000]:1357;branch=z9hG4bK74bf9

Route: <sip:p.a1.under.test.com:10001;lr>, <sip:orig@s.a1.under.test.com;lr>

Max-Forwards: 70

From: <sip:UEa1_public_1@under.test.com>;tag=9fxced76sl

To: <sip:UEa2_public_1@under.test.com>;tag=314259

Call-ID: 3848276298220188511@under.test.com

CSeq: 1 ACK

Content-Length: 0

[OBSERVABLE RESULTS]

*1: 4 ACK from NUT to P-CSCF.

See generic_ACK-non2XX

4.7.8 UE-RR-B-8-AKA - Receiving 405 response

[NAME]

UE-RR-B-8-AKA - Receiving 405 response

[TARGET]

IMS User Equipment (NUT)

[PURPOSE]

To verify that the UEa1 properly process a 405 (Method Not Allowed) response, and verify that the UEa1 properly creates an ACK request.

[REFERENCE]

TS24.229 A.2.1.4.1

[REQUIREMENT]

NONE



[PARAMETER(NUT)]

public-user-id : sip:UEa1_public_1@under.test.com
private-user-id : UEa1_private@under.test.com
contact_URI : sip:UEa1_public_1@node.under.test.com
HOMENETWORK Domain : sip:under.test.com

[PARAMETER(TESTER)]

public-user-id(UEa2) : sip:UEa2_public_1@under.test.com
P-CSCFa1 : sip:p.a1.under.test.com

[ADDRESS]

UEa1(NUT) : 3ffe:501:fff:1000::1000
Router(R1) : 3ffe:501:fff:1000::1
P-CSCFa1 : 3ffe:501:fff:100::10
I-CSCFa1 : 3ffe:501:fff:100::20
S-CSCFa1 : 3ffe:501:fff:100::30
DNS : 3ffe:501:fff:100::40
DHCP : 3ffe:501:fff:100::50

UEa2 : 3ffe:501:fff:2000::1000
P-CSCFa2 : 3ffe:501:fff:200::10
I-CSCFa2 : 3ffe:501:fff:200::20
S-CSCFa2 : 3ffe:501:fff:200::30

[TOPOLOGY]

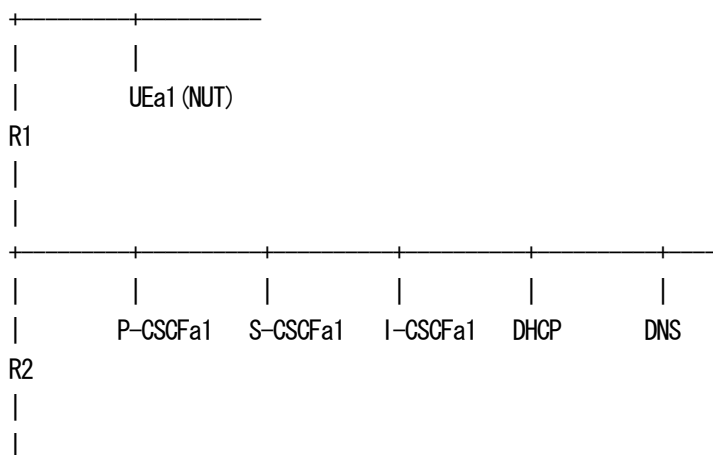

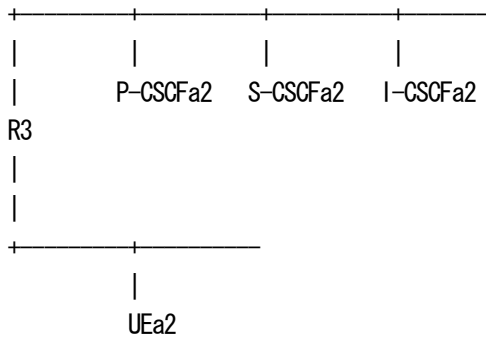

[INITIALIZATION]

UEa1(NUT) must be registered with the tester by executing the scenario "UE-INI-B-1-AKA".
 For details of "UE-INI-B-1-AKA", refer to the profile "UE-RG-B-1-AKA".

[PROCEDURE]

Home Network

(NUT)

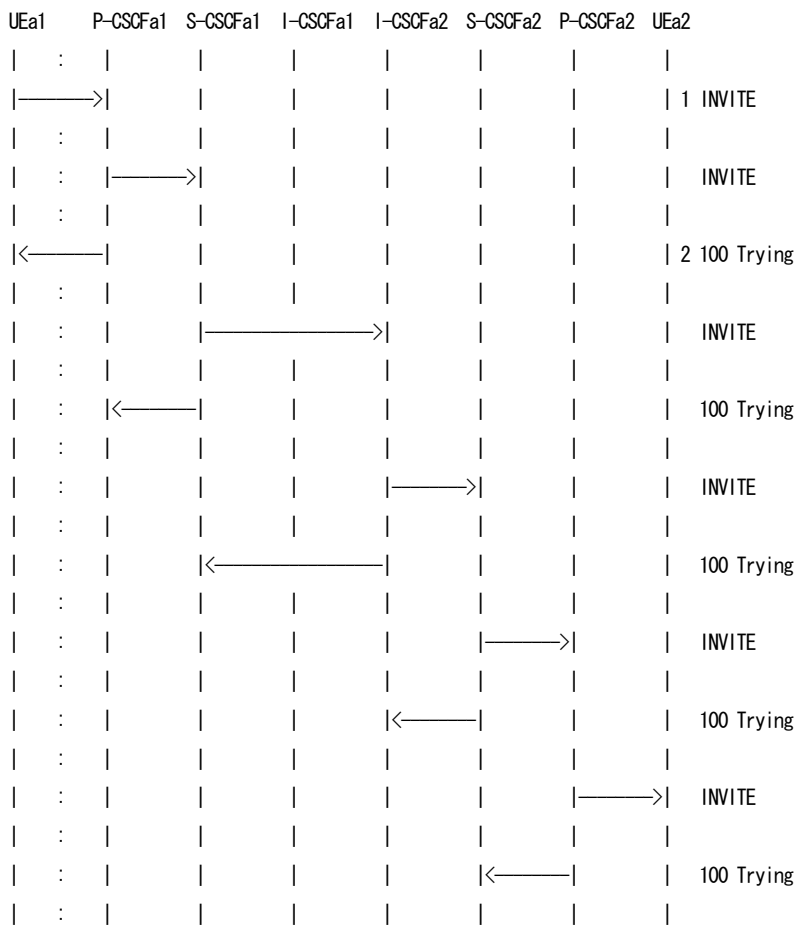



Allow: INVITE
Content-Length: 0

4. ACK NUT -> P-CSCF
ACK sip:UEa2_public_1@under.test.com SIP/2.0
Via: SIP/2.0/UDP [3ffe:501:ffff:1000::1000]:1357;branch=z9hG4bK74bf9
Route: <sip:p.a1.under.test.com:10001;lr>,<sip:orig@s.a1.under.test.com;lr>
Max-Forwards: 70
From: <sip:UEa1_public_1@under.test.com>;tag=9fxced76sl
To: <sip:UEa2_public_1@under.test.com>;tag=314259
Call-ID: 3848276298220188511@under.test.com
CSeq: 1 ACK
Content-Length: 0

[OBSERVABLE RESULTS]

*1: 4 ACK from NUT to P-CSCF.

See generic_ACK-non2XX

4.7.9 UE-RR-B-9-AKA - Receiving 406 response

[NAME]

UE-RR-B-9-AKA - Receiving 406 response

[TARGET]

IMS User Equipment (NUT)

[PURPOSE]

To verify that the UEa1 properly process a 406 (Not Acceptable) response, and verify that the UEa1 properly creates a initial INVITE request.

[REFERENCE]

TS24.229 A.2.1.4.1

[REQUIREMENT]



NONE

[PARAMETER(NUT)]

public-user-id : sip:UEa1_public_1@under.test.com
private-user-id : UEa1_private@under.test.com
contact_URI : sip:UEa1_public_1@node.under.test.com
HOMENETWORK Domain : sip:under.test.com

[PARAMETER(TESTER)]

public-user-id(UEa2) : sip:UEa2_public_1@under.test.com
P-CSCFa1 : sip:p.a1.under.test.com

[ADDRESS]

UEa1(NUT) : 3ffe:501:fff:1000::1000
Router(R1) : 3ffe:501:fff:1000::1
P-CSCFa1 : 3ffe:501:fff:100::10
I-CSCFa1 : 3ffe:501:fff:100::20
S-CSCFa1 : 3ffe:501:fff:100::30
DNS : 3ffe:501:fff:100::40
DHCP : 3ffe:501:fff:100::50

UEa2 : 3ffe:501:fff:2000::1000
P-CSCFa2 : 3ffe:501:fff:200::10
I-CSCFa2 : 3ffe:501:fff:200::20
S-CSCFa2 : 3ffe:501:fff:200::30

[TOPOLOGY]

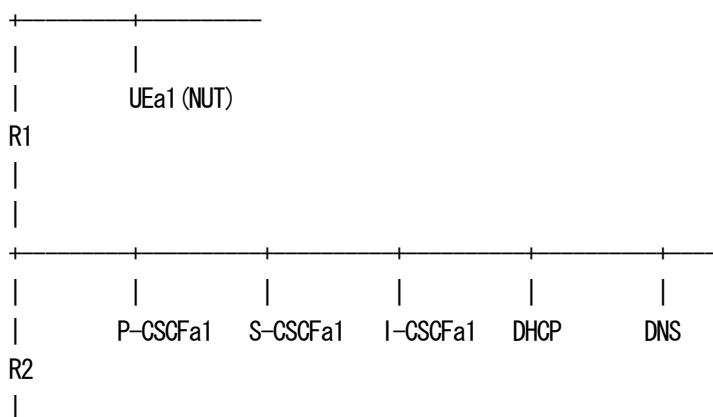

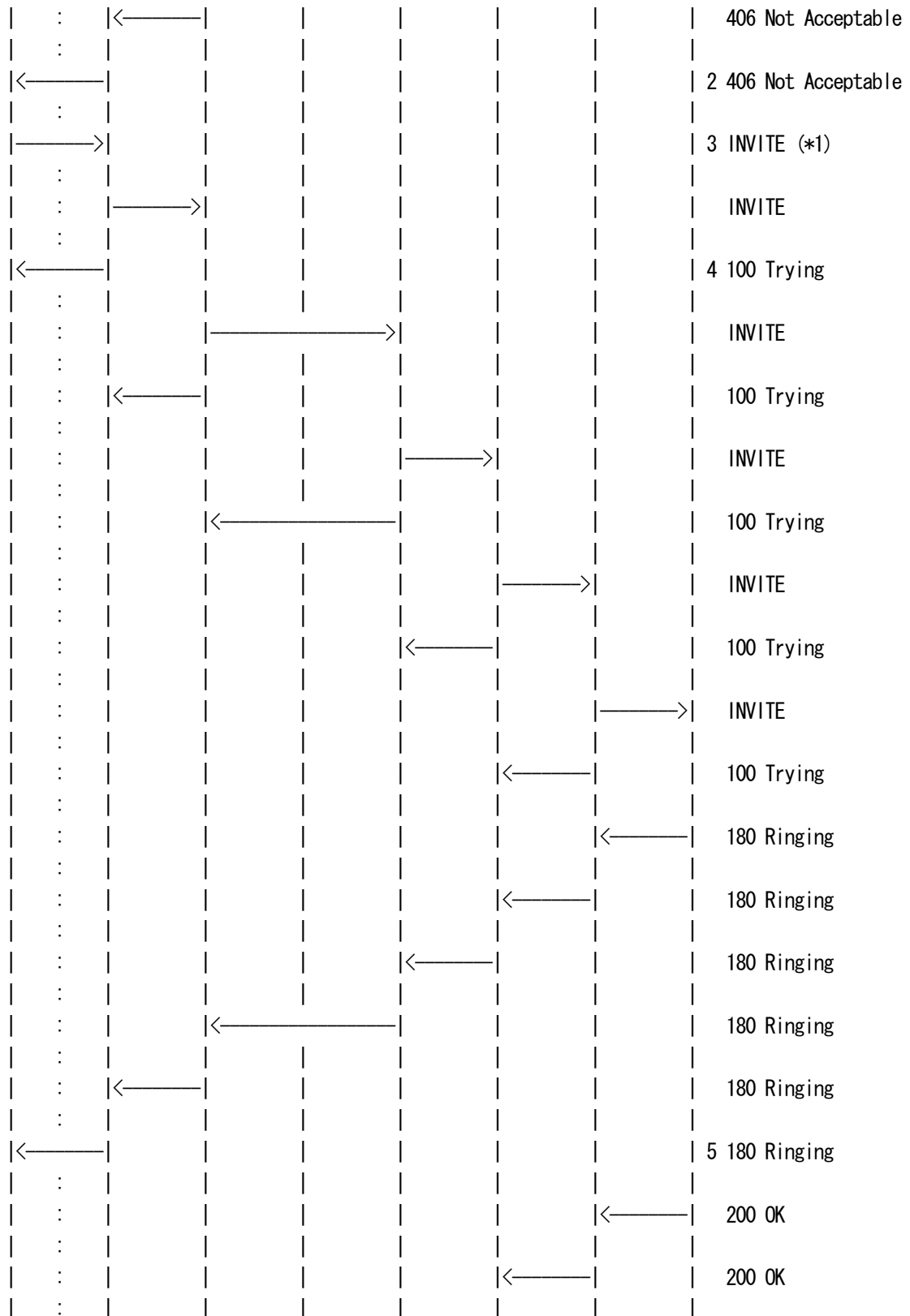

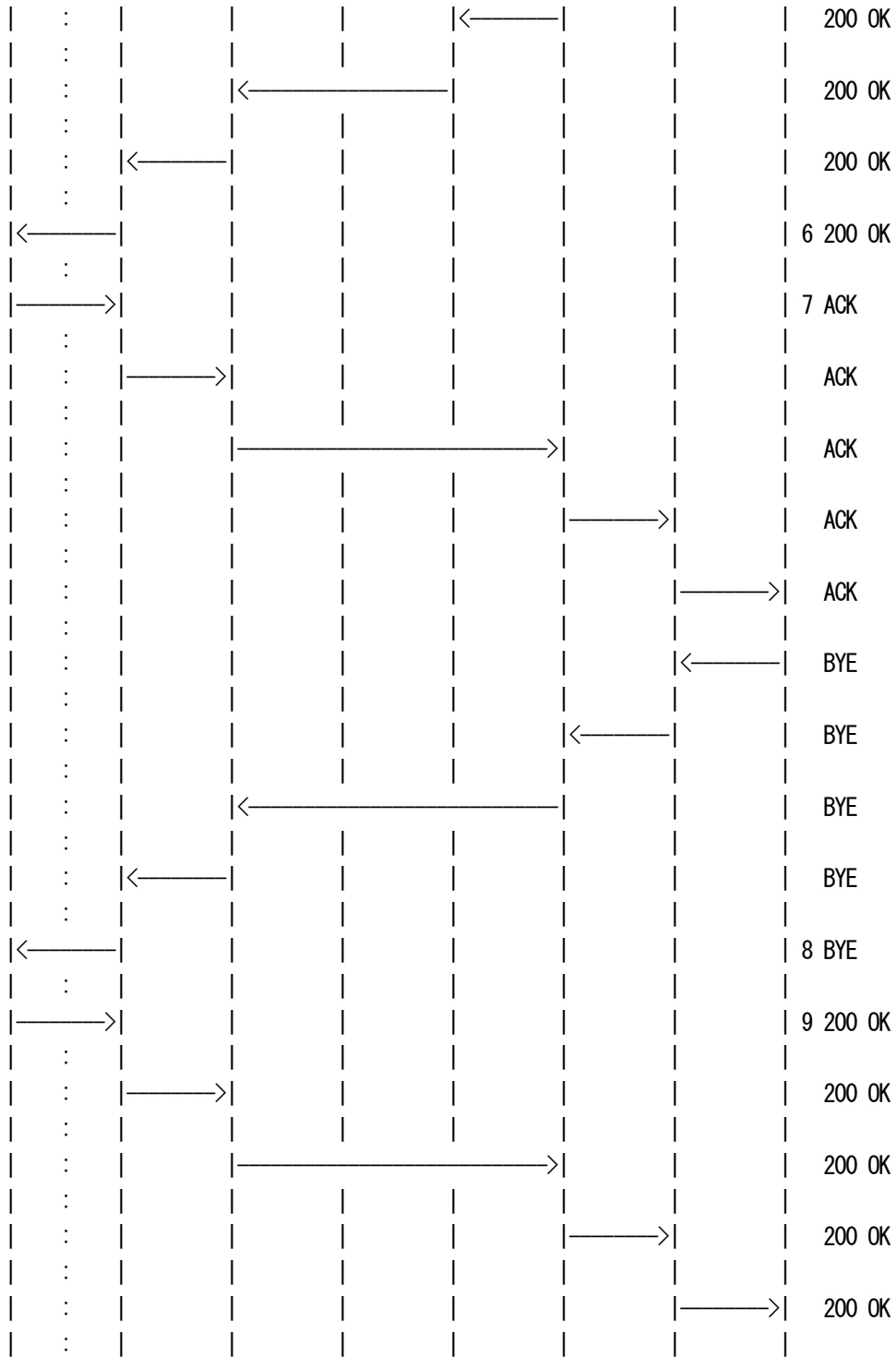

- 1 NUT sends OPTIONS
- 2 NUT receives 406 Not Acceptable
- 3 NUT sends INVITE



4 NUT receives 100 Trying
5 NUT receives 180 Ringing
6 NUT receives 200 OK
7 NUT sends ACK
8 NUT receives BYE
9 NUT sends 200 OK

=== Message example ===

As regards the message 1, please refer to the message 1 in UE-OP-B-1-AKA.

2. 406 Not Acceptable P-CSCF -> NUT
SIP/2.0 406 Not Acceptable
Via: SIP/2.0/UDP [3ffe:501:ffff:1000::1000]:1357;branch=z9hG4bK74b1a
From: <sip:UEa1_public_1@under.test.com>;tag=9fxced76tm
To: <sip:UEa2_public_1@under.test.com>;tag=314071
Call-ID: 3848276298220188522@under.test.com
CSeq: 1 OPTIONS
Content-Length: 0

As regards the message 3-9, please refer to the message 1-7 in UE-SE-B-1-AKA.

[OBSERVABLE RESULTS]

*1: 3 INVITE from NUT to P-CSCF.

See generic_INVITE

4.7.10 UE-RR-B-10-AKA - Receiving 410 response

[NAME]
UE-RR-B-10-AKA - Receiving 410 response

[TARGET]
IMS User Equipment (NUT)



[PURPOSE]

To verify that the UEa1 properly process a 410 (Gone) response,
and verify that the UEa1 properly creates an ACK request.

[REFERENCE]

TS24.229 A.2.1.4.1

[REQUIREMENT]

NONE

[PARAMETER(NUT)]

public-user-id : sip:UEa1_public_1@under.test.com
private-user-id : UEa1_private@under.test.com
contact_URI : sip:UEa1_public_1@node.under.test.com
HOMENETWORK Domain : sip:under.test.com

[PARAMETER(TESTER)]

public-user-id(UEa2) : sip:UEa2_public_1@under.test.com
P-CSCFa1 : sip:p.a1.under.test.com

[ADDRESS]

UEa1(NUT) : 3ffe:501:fff:1000::1000
Router(R1) : 3ffe:501:fff:1000::1
P-CSCFa1 : 3ffe:501:fff:100::10
I-CSCFa1 : 3ffe:501:fff:100::20
S-CSCFa1 : 3ffe:501:fff:100::30
DNS : 3ffe:501:fff:100::40
DHCP : 3ffe:501:fff:100::50

UEa2 : 3ffe:501:fff:2000::1000
P-CSCFa2 : 3ffe:501:fff:200::10
I-CSCFa2 : 3ffe:501:fff:200::20
S-CSCFa2 : 3ffe:501:fff:200::30

[TOPOLOGY]

+-----+

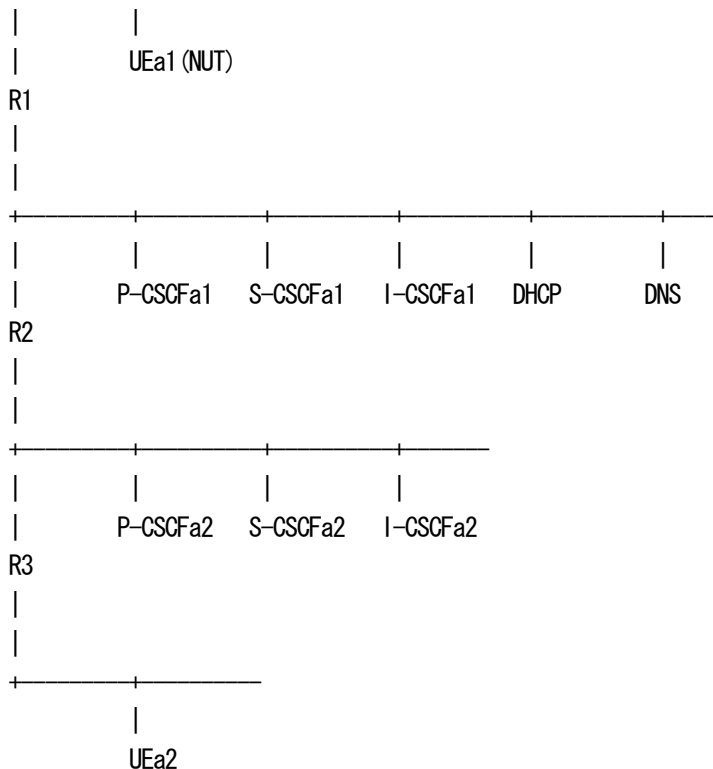

[INITIALIZATION]

UEa1(NUT) must be registered with the tester by executing the scenario "UE-INI-B-1-AKA".
For details of "UE-INI-B-1-AKA", refer to the profile "UE-RG-B-1-AKA".

[PROCEDURE]

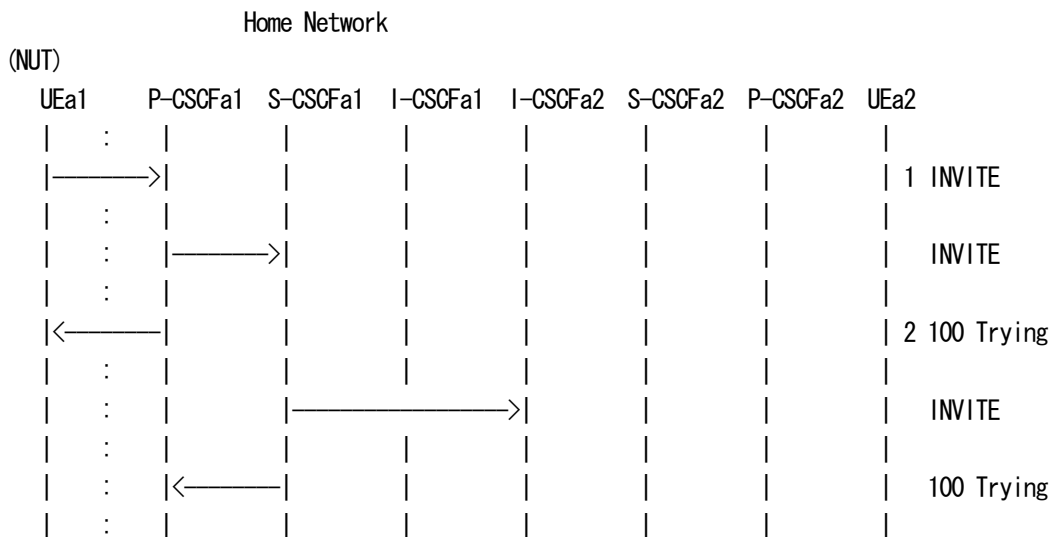

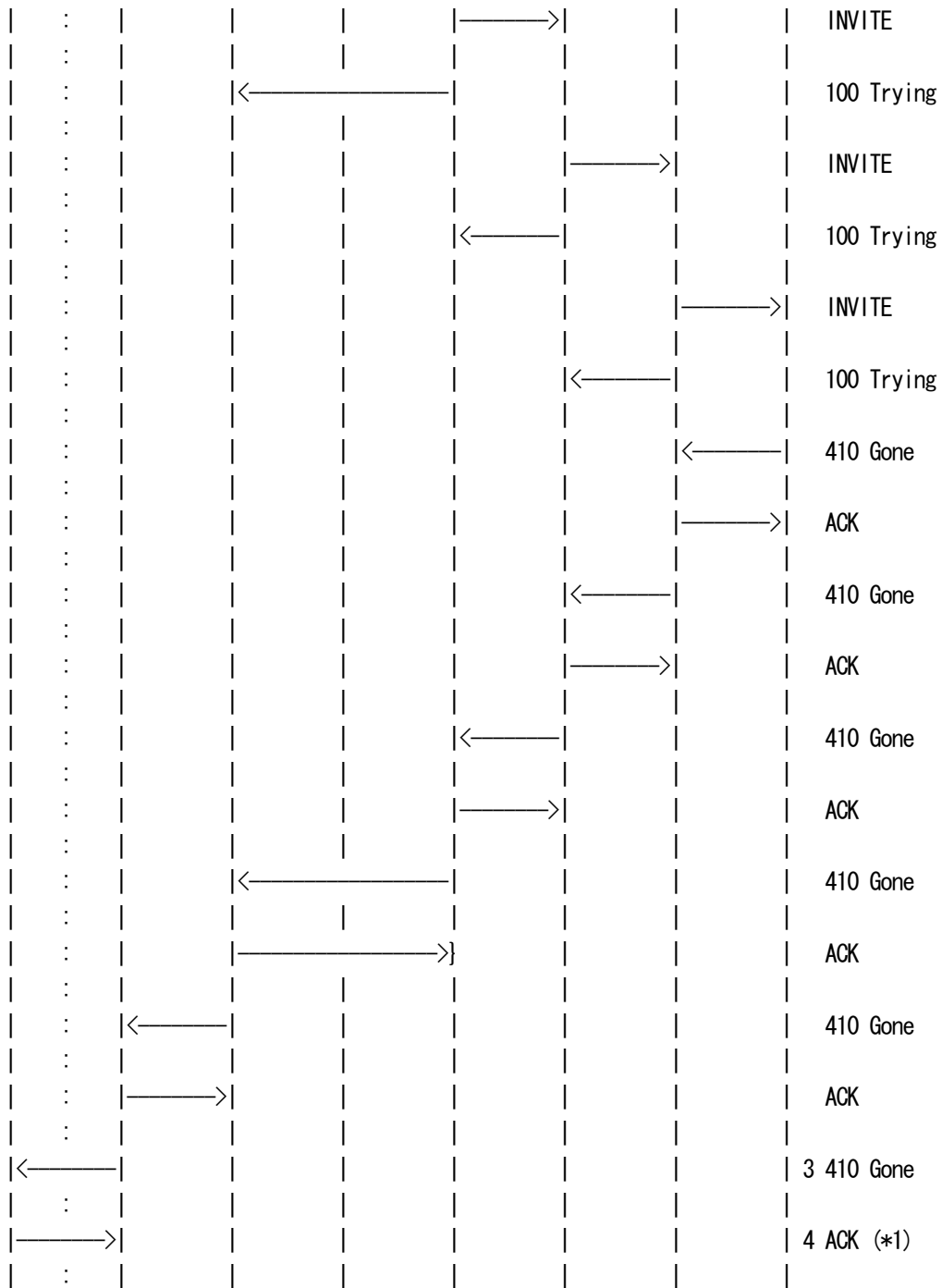

- 1 NUT sends INVITE
- 2 NUT receives 100 Trying
- 3 NUT receives 410 Gone
- 4 NUT sends ACK



==== Message example ====

As regards the message 1-2, please refer to the message 1-2 in UE-SE-B-1-AKA.

3. 410 Gone P-CSCF -> NUT

SIP/2.0 410 Gone

Via: SIP/2.0/UDP [3ffe:501:ffff:1000::1000]:1357;branch=z9hG4bK74bf9

From: <sip:UEa1_public_1@under.test.com>;tag=9fxced76sl

To: <sip:UEa2_public_1@under.test.com>;tag=314259

Call-ID: 3848276298220188511@under.test.com

CSeq: 1 INVITE

Content-Length: 0

4. ACK NUT -> P-CSCF

ACK sip:UEa2_public_1@under.test.com SIP/2.0

Via: SIP/2.0/UDP [3ffe:501:ffff:1000::1000]:1357;branch=z9hG4bK74bf9

Route: <sip:p.a1.under.test.com:10001;lr>,<sip:orig@s.a1.under.test.com;lr>

Max-Forwards: 70

From: <sip:UEa1_public_1@under.test.com>;tag=9fxced76sl

To: <sip:UEa2_public_1@under.test.com>;tag=314259

Call-ID: 3848276298220188511@under.test.com

CSeq: 1 ACK

Content-Length: 0

[OBSERVABLE RESULTS]

*1: 4 ACK from NUT to P-CSCF.

See generic_ACK-non2XX

4.7.11 UE-RR-B-11-AKA - Receiving 413 response

[NAME]

UE-RR-B-11-AKA - Receiving 413 response

[TARGET]

IMS User Equipment (NUT)



[PURPOSE]

To verify that the UEa1 properly process a 413 (Request Entity Too Large) response, and verify that the UEa1 properly creates an ACK request.

[REFERENCE]

TS24.229 A.2.1.4.1

[REQUIREMENT]

NONE

[PARAMETER(NUT)]

public-user-id : sip:UEa1_public_1@under.test.com
private-user-id : UEa1_private@under.test.com
contact_URI : sip:UEa1_public_1@node.under.test.com
HOMENETWORK Domain : sip:under.test.com

[PARAMETER(TESTER)]

public-user-id(UEa2) : sip:UEa2_public_1@under.test.com
P-CSCFa1 : sip:p.a1.under.test.com

[ADDRESS]

UEa1(NUT) : 3ffe:501:fff:1000::1000
Router(R1) : 3ffe:501:fff:1000::1
P-CSCFa1 : 3ffe:501:fff:100::10
I-CSCFa1 : 3ffe:501:fff:100::20
S-CSCFa1 : 3ffe:501:fff:100::30
DNS : 3ffe:501:fff:100::40
DHCP : 3ffe:501:fff:100::50

UEa2 : 3ffe:501:fff:2000::1000
P-CSCFa2 : 3ffe:501:fff:200::10
I-CSCFa2 : 3ffe:501:fff:200::20
S-CSCFa2 : 3ffe:501:fff:200::30

[TOPOLOGY]

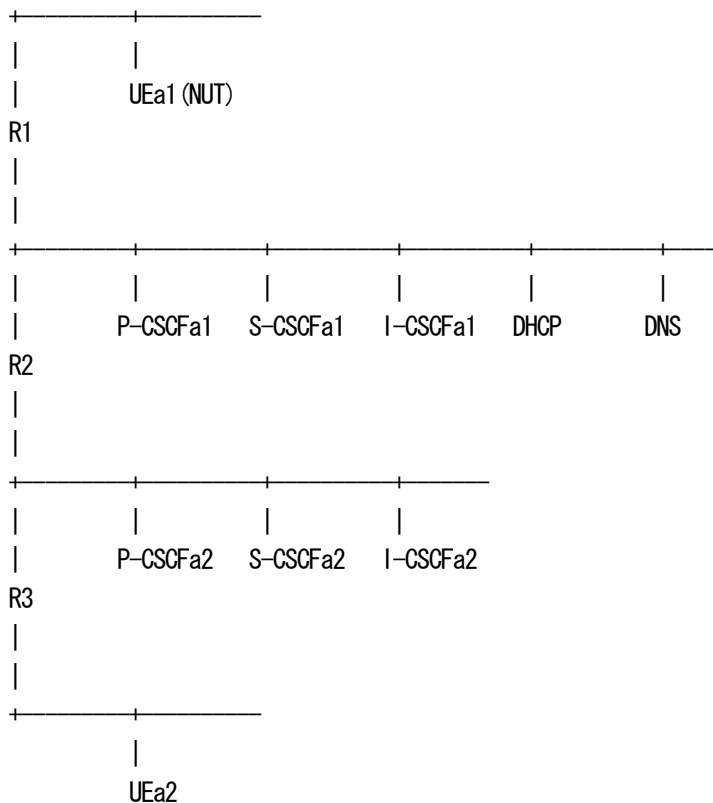

[INITIALIZATION]

UEa1(NUT) must be registered with the tester by executing the scenario "UE-INI-B-1-AKA".
 For details of "UE-INI-B-1-AKA", refer to the profile "UE-RG-B-1-AKA".

[PROCEDURE]

Home Network

(NUT)

UEa1	P-CSCFa1	S-CSCFa1	I-CSCFa1	I-CSCFa2	S-CSCFa2	P-CSCFa2	UEa2
	:						
	→						1 INVITE
	:						
	:	→					INVITE
	:						
	←						2 100 Trying
	:						
	:		→				INVITE
	:						
	:	←					100 Trying
	:						

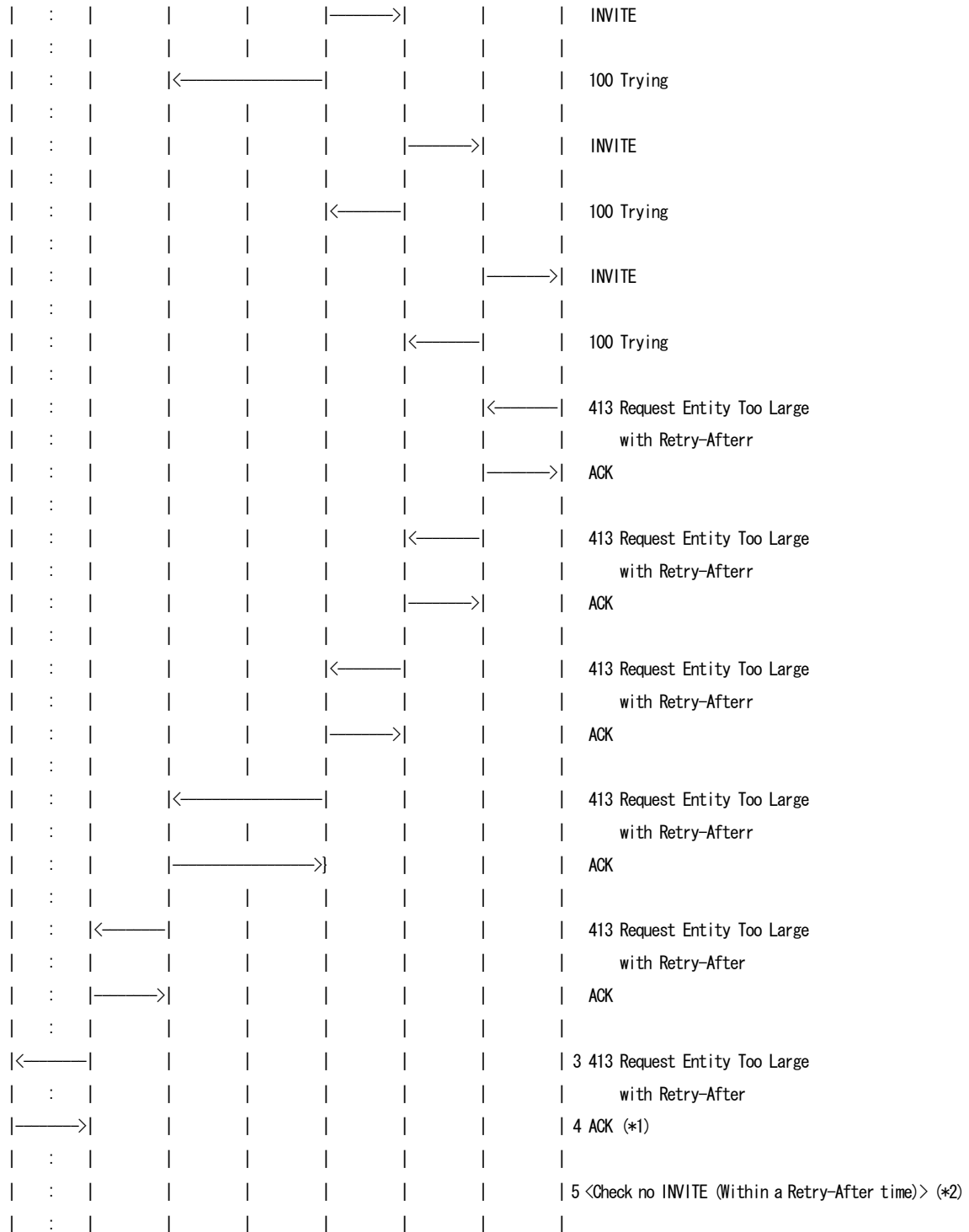

- 1 NUT sends INVITE
- 2 NUT receives 100 Trying
- 3 NUT receives 413 Request Entity Too Large with Retry-After



- 4 NUT sends ACK
- 5 <Check no INVITE (Within a Retry-After time)>

==== Message example ====

As regards the message 1-2, please refer to the message 1-2 in UE-SE-B-1-AKA.

3. 413 Request Entity Too Large P-CSCF -> NUT
SIP/2.0 413 Request Entity Too Large
Via: SIP/2.0/UDP [3ffe:501:ffff:1000::1000]:1357;branch=z9hG4bK74bf9
From: <sip:UEa1_public_1@under.test.com>;tag=9fxced76sl
To: <sip:UEa2_public_1@under.test.com>;tag=314259
Call-ID: 3848276298220188511@under.test.com
CSeq: 1 INVITE
Retry-After: 30
Content-Length: 0

4. ACK NUT -> P-CSCF
ACK sip:UEa2_public_1@under.test.com SIP/2.0
Via: SIP/2.0/UDP [3ffe:501:ffff:1000::1000]:1357;branch=z9hG4bK74bf9
Route: <sip:p.a1.under.test.com:10001;lr>,<sip:orig@s.a1.under.test.com;lr>
Max-Forwards: 70
From: <sip:UEa1_public_1@under.test.com>;tag=9fxced76sl
To: <sip:UEa2_public_1@under.test.com>;tag=314259
Call-ID: 3848276298220188511@under.test.com
CSeq: 1 ACK
Content-Length: 0

- 5. <Check no INVITE (Within a Retry-After time)>

[OBSERVABLE RESULTS]

*1: 4 ACK from NUT to P-CSCF.

See generic_ACK-non2XX

*2: 5 Check no INVITE (Within a Retry-After time) from NUT to P-CSCF.



4.7.12 UE-RR-B-12-AKA - Receiving 414 response

[NAME]

UE-RR-B-12-AKA - Receiving 414 response

[TARGET]

IMS User Equipment (NUT)

[PURPOSE]

To verify that the UEa1 properly process a 414 (Request-URI Too Large) response, and verify that the UEa1 properly creates an ACK request.

[REFERENCE]

TS24.229 A.2.1.4.1

[REQUIREMENT]

NONE

[PARAMETER(NUT)]

public-user-id : sip:UEa1_public_1@under.test.com
private-user-id : UEa1_private@under.test.com
contact_URI : sip:UEa1_public_1@node.under.test.com
HOMENETWORK Domain : sip:under.test.com

[PARAMETER(TESTER)]

public-user-id(UEa2) : sip:UEa2_public_1@under.test.com
P-CSCFa1 : sip:p.a1.under.test.com

[ADDRESS]

UEa1(NUT) : 3ffe:501:fff:1000::1000
Router(R1) : 3ffe:501:fff:1000::1
P-CSCFa1 : 3ffe:501:fff:100::10
I-CSCFa1 : 3ffe:501:fff:100::20
S-CSCFa1 : 3ffe:501:fff:100::30



DNS : 3fe:501:fff:100::40
 DHCP : 3fe:501:fff:100::50

 UEa2 : 3fe:501:fff:2000::1000
 P-CSCFa2 : 3fe:501:fff:200::10
 I-CSCFa2 : 3fe:501:fff:200::20
 S-CSCFa2 : 3fe:501:fff:200::30

[TOPOLOGY]

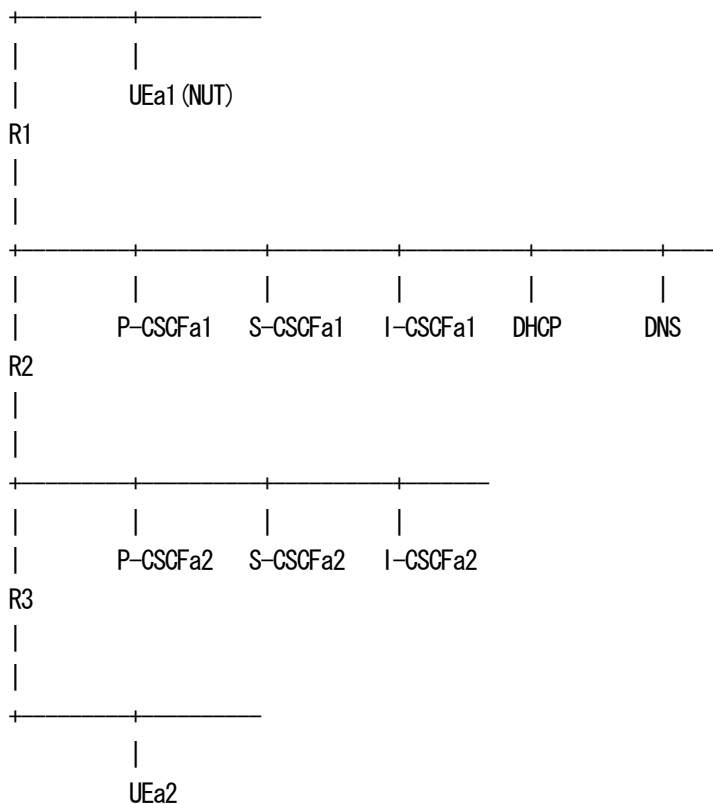

[INITIALIZATION]

UEa1(NUT) must be registered with the tester by executing the scenario "UE-INI-B-1-AKA".
 For details of "UE-INI-B-1-AKA", refer to the profile "UE-RG-B-1-AKA".

[PROCEDURE]

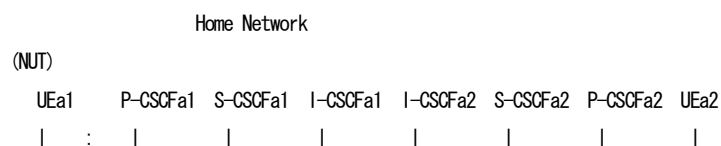



See generic_ACK-non2XX

4.7.13 UE-RR-B-13-AKA - Receiving 415 response

[NAME]

UE-RR-B-13-AKA - Receiving 415 response

[TARGET]

IMS User Equipment (NUT)

[PURPOSE]

To verify that the UEa1 properly process a 415 (Unsupported Media Type) response, and verify that the UEa1 properly creates an ACK request and retry modified INVITE request.

[REFERENCE]

TS24.229 A.2.1.4.1

[REQUIREMENT]

Two media type support.

[PARAMETER(NUT)]

public-user-id : sip:UEa1_public_1@under.test.com
private-user-id : UEa1_private@under.test.com
contact_URI : sip:UEa1_public_1@node.under.test.com
HOMENETWORK Domain : sip:under.test.com

[PARAMETER(TESTER)]

public-user-id(UEa2) : sip:UEa2_public_1@under.test.com
P-CSCFa1 : sip:p.a1.under.test.com

[ADDRESS]

UEa1(NUT) : 3ffe:501:fff:1000::1000
Router(R1) : 3ffe:501:fff:1000::1
P-CSCFa1 : 3ffe:501:fff:100::10



I-CSCFa1	:	3ffe:501:fff:100::20
S-CSCFa1	:	3ffe:501:fff:100::30
DNS	:	3ffe:501:fff:100::40
DHCP	:	3ffe:501:fff:100::50
UEa2	:	3ffe:501:fff:2000::1000
P-CSCFa2	:	3ffe:501:fff:200::10
I-CSCFa2	:	3ffe:501:fff:200::20
S-CSCFa2	:	3ffe:501:fff:200::30

[TOPOLOGY]

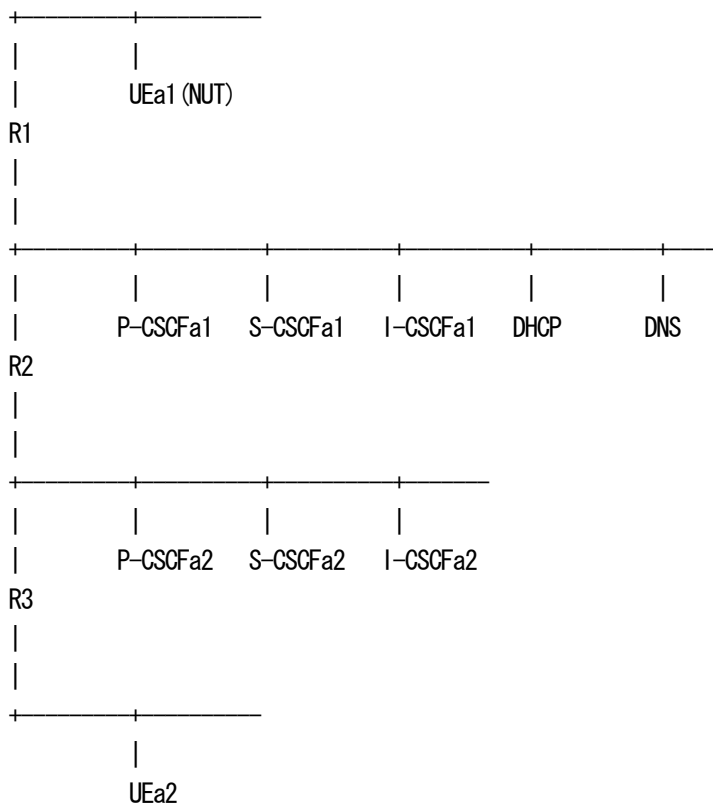

[INITIALIZATION]

UEa1(NUT) must be registered with the tester by executing the scenario "UE-INI-B-1-AKA".
For details of "UE-INI-B-1-AKA", refer to the profile "UE-RG-B-1-AKA".

[PROCEDURE]

Home Network

(NUT)

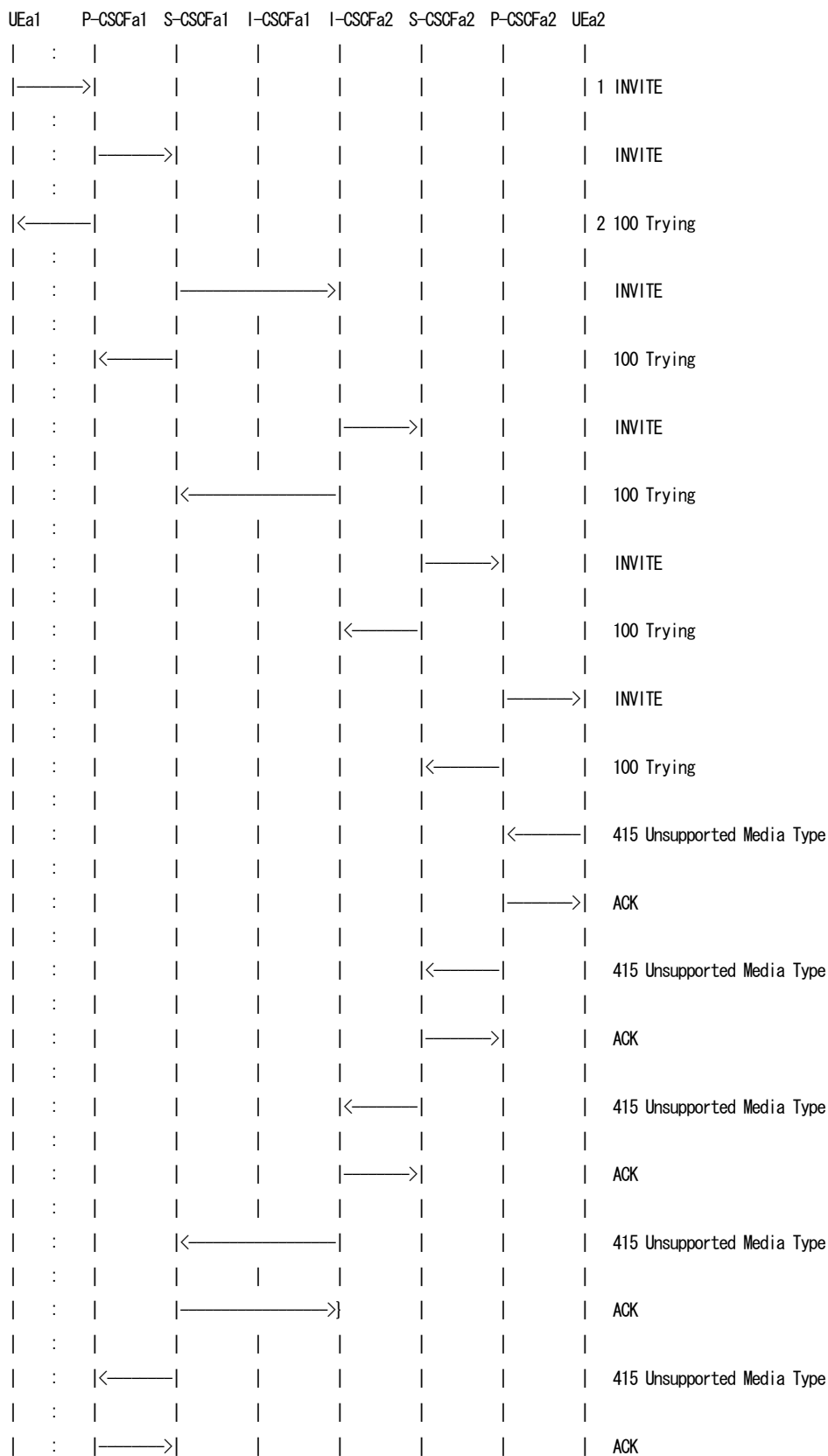



- 1 NUT sends INVITE
- 2 NUT receives 100 Trying
- 3 NUT receives 415 Unsupported Media Type
- 4 NUT sends ACK

=== Message example ===

As regards the message 1-2, please refer to the message 1-2 in UE-SE-B-1-AKA.

3. 415 Unsupported Media Type P-CSCF -> NUT
SIP/2.0 415 Unsupported Media Type
Via: SIP/2.0/UDP [3ffe:501:ffff:1000::1000]:1357;branch=z9hG4bK74bf9
From: <sip:UEa1_public_1@under.test.com>;tag=9fxced76sl
To: <sip:UEa2_public_1@under.test.com>;tag=314259
Call-ID: 3848276298220188511@under.test.com
CSeq: 1 INVITE
Accept: application/sdp,application/3gpp-ims+xml
Content-Length: 0

4. ACK NUT -> P-CSCF
ACK sip:UEa2_public_1@under.test.com SIP/2.0
Via: SIP/2.0/UDP [3ffe:501:ffff:1000::1000]:1357;branch=z9hG4bK74bf9
Route: <sip:p.a1.under.test.com:10001;lr>,<sip:orig@s.a1.under.test.com;lr>
Max-Forwards: 70
From: <sip:UEa1_public_1@under.test.com>;tag=9fxced76sl
To: <sip:UEa2_public_1@under.test.com>;tag=314259
Call-ID: 3848276298220188511@under.test.com
CSeq: 1 ACK
Content-Length: 0

[OBSERVABLE RESULTS]

*1: 4 ACK from NUT to P-CSCF.



See generic_ACK-non2XX

4.7.14 UE-RR-B-14-AKA - Response 480 response

[NAME]

UE-RR-B-14-AKA - Receiving 480 response

[TARGET]

IMS User Equipment (NUT)

[PURPOSE]

To verify that the UEa1 properly process a 480 (Temporarily Unavailable) response, and verify that the UEa1 properly creates an ACK request.

[REFERENCE]

TS24.229 A.2.1.4.1

[REQUIREMENT]

NONE

[PARAMETER(NUT)]

public-user-id : sip:UEa1_public_1@under.test.com
private-user-id : UEa1_private@under.test.com
contact_URI : sip:UEa1_public_1@node.under.test.com
HOMENETWORK Domain : sip:under.test.com

[PARAMETER(TESTER)]

public-user-id(UEa2) : sip:UEa2_public_1@under.test.com
P-CSCFa1 : sip:p.a1.under.test.com

[ADDRESS]

UEa1(NUT) : 3ffe:501:fff:1000::1000
Router(R1) : 3ffe:501:fff:1000::1
P-CSCFa1 : 3ffe:501:fff:100::10



I-CSCFa1	:	3ffe:501:fff:100::20
S-CSCFa1	:	3ffe:501:fff:100::30
DNS	:	3ffe:501:fff:100::40
DHCP	:	3ffe:501:fff:100::50
UEa2	:	3ffe:501:fff:2000::1000
P-CSCFa2	:	3ffe:501:fff:200::10
I-CSCFa2	:	3ffe:501:fff:200::20
S-CSCFa2	:	3ffe:501:fff:200::30

[TOPOLOGY]

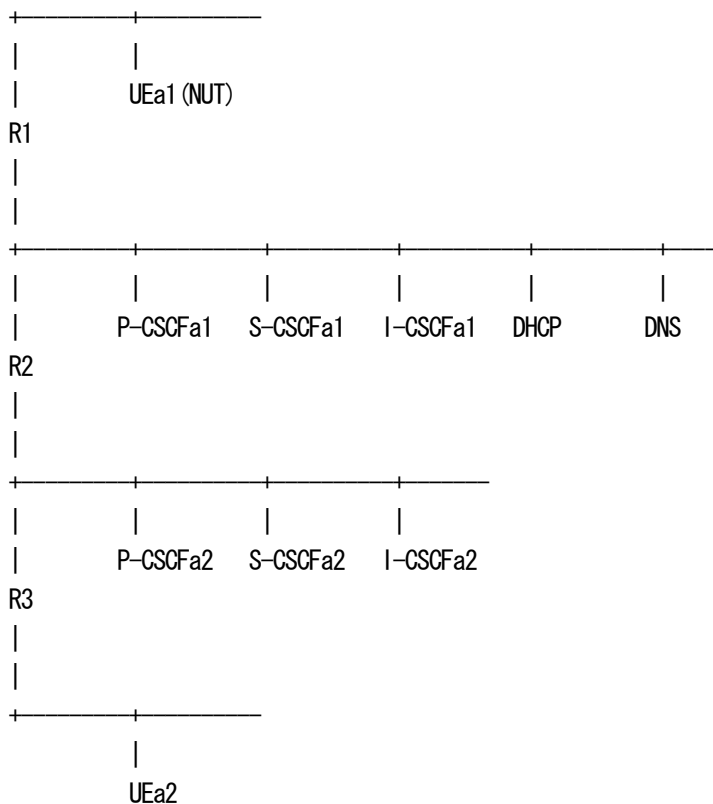

[INITIALIZATION]

UEa1(NUT) must be registered with the tester by executing the scenario "UE-INI-B-1-AKA".
 For details of "UE-INI-B-1-AKA", refer to the profile "UE-RG-B-1-AKA".

[PROCEDURE]

Home Network

(NUT)



UEa1	P-CSCFa1	S-CSCFa1	I-CSCFa1	I-CSCFa2	S-CSCFa2	P-CSCFa2	UEa2
:							
———>							1 INVITE
:							
<———							2 480 Temporarily Unavailable
:							
———>							3 ACK (*1)
:							

- 1 NUT sends INVITE
- 2 NUT receives 480 Temporarily Unavailable
- 3 NUT sends ACK

=== Message example ===

As regards the message 1, please refer to the message 1 in UE-SE-B-1-AKA.

2. 480 Temporarily Unavailable P-CSCF -> NUT
 SIP/2.0 480 Temporarily Unavailable
 Via: SIP/2.0/UDP [3ffe:501:ffff:1000::1000]:1357;branch=z9hG4bK74bf9
 From: <sip:UEa1_public_1@under.test.com>;tag=9fxced76sl
 To: <sip:UEa2_public_1@under.test.com>;tag=314259
 Call-ID: 3848276298220188511@under.test.com
 CSeq: 1 INVITE
 Content-Length: 0

3. ACK NUT -> P-CSCF
 ACK sip:UEa2_public_1@under.test.com SIP/2.0
 Via: SIP/2.0/UDP [3ffe:501:ffff:1000::1000]:1357;branch=z9hG4bK74bf9
 Route: <sip:p.a1.under.test.com:10001;lr>,<sip:orig@s.a1.under.test.com;lr>
 Max-Forwards: 70
 From: <sip:UEa1_public_1@under.test.com>;tag=9fxced76sl
 To: <sip:UEa2_public_1@under.test.com>;tag=314259
 Call-ID: 3848276298220188511@under.test.com
 CSeq: 1 ACK
 Content-Length: 0

[OBSERVABLE RESULTS]



*1: 3 ACK from NUT to P-CSCF.

See generic_ACK-non2XX

4.7.15 UE-RR-B-15-AKA - Receiving 482 response

[NAME]

UE-RR-B-15-AKA - Receiving 482 response

[TARGET]

IMS User Equipment (NUT)

[PURPOSE]

To verify that the UEa1 properly process a 482 (Loop Detected) response, and verify that the UEa1 properly creates an ACK request.

[REFERENCE]

TS24.229 A.2.1.4.1

[REQUIREMENT]

NONE

[PARAMETER(NUT)]

public-user-id : sip:UEa1_public_1@under.test.com
private-user-id : UEa1_private@under.test.com
contact_URI : sip:UEa1_public_1@node.under.test.com
HOMENETWORK Domain : sip:under.test.com

[PARAMETER(TESTER)]

public-user-id(UEa2) : sip:UEa2_public_1@under.test.com
P-CSCFa1 : sip:p.a1.under.test.com

[ADDRESS]

UEa1(NUT) : 3ffe:501:ffff:1000::1000
Router(R1) : 3ffe:501:ffff:1000::1



P-CSCFa1	:	3ffe:501:fff:100::10
I-CSCFa1	:	3ffe:501:fff:100::20
S-CSCFa1	:	3ffe:501:fff:100::30
DNS	:	3ffe:501:fff:100::40
DHCP	:	3ffe:501:fff:100::50
UEa2	:	3ffe:501:fff:2000::1000
P-CSCFa2	:	3ffe:501:fff:200::10
I-CSCFa2	:	3ffe:501:fff:200::20
S-CSCFa2	:	3ffe:501:fff:200::30

[TOPOLOGY]

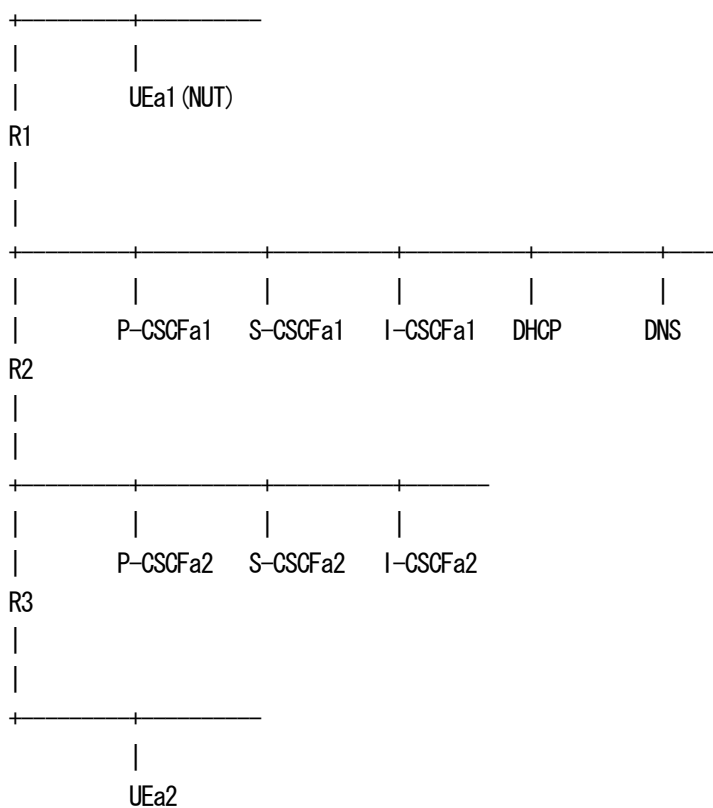

[INITIALIZATION]

UEa1(NUT) must be registered with the tester by executing the scenario "UE-INI-B-1-AKA".
For details of "UE-INI-B-1-AKA", refer to the profile "UE-RG-B-1-AKA".

[PROCEDURE]



Home Network

(NUT)

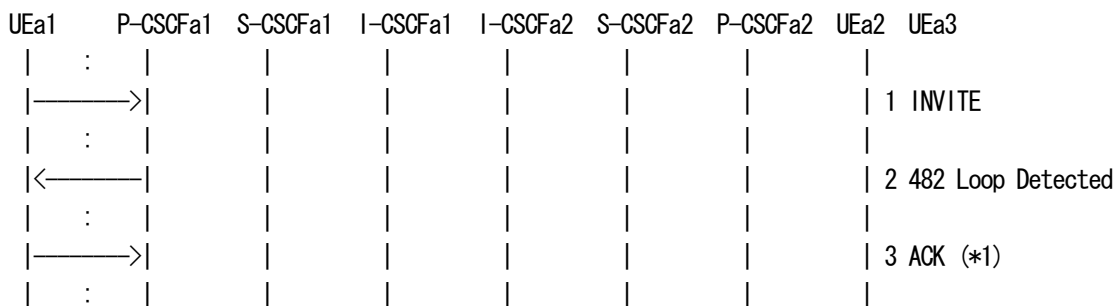

- 1 NUT sends INVITE
- 2 NUT receives 482 Loop Detected
- 3 NUT sends ACK

=== Message example ===

As regards the message 1, please refer to the message 1 in UE-SE-B-1-AKA.

2. 482 Loop Detected P-CSCF -> NUT

SIP/2.0 482 Loop Detected

Via: SIP/2.0/UDP [3ffe:501:ffff:1000::1000]:1357;branch=z9hG4bK74bf9

From: <sip:UEa1_public_1@under.test.com>;tag=9fxced76sl

To: <sip:UEa2_public_1@under.test.com>;tag=314259

Call-ID: 3848276298220188511@under.test.com

CSeq: 1 INVITE

Content-Length: 0

3. ACK NUT -> P-CSCF

ACK sip:UEa2_public_1@under.test.com SIP/2.0

Via: SIP/2.0/UDP [3ffe:501:ffff:1000::1000]:1357;branch=z9hG4bK74bf9

Route: <sip:p.a1.under.test.com:10001;lr>,<sip:orig@s.a1.under.test.com;lr>

Max-Forwards: 70

From: <sip:UEa1_public_1@under.test.com>;tag=9fxced76sl

To: <sip:UEa2_public_1@under.test.com>;tag=314259

Call-ID: 3848276298220188511@under.test.com

CSeq: 1 ACK

Content-Length: 0



[OBSERVABLE RESULTS]

*1: 3 ACK from NUT to P-CSCF.

See generic_ACK-non2XX

4.7.16 UE-RR-B-16-AKA - Receiving 483 response

[NAME]

UE-RR-B-16-AKA - Receiving 483 response

[TARGET]

IMS User Equipment (NUT)

[PURPOSE]

To verify that the UEa1 properly process a 483 (Too Many Hops) response, and verify that the UEa1 properly creates an ACK request.

[REFERENCE]

TS24.229 A.2.1.4.1

[REQUIREMENT]

NONE

[PARAMETER(NUT)]

public-user-id : sip:UEa1_public_1@under.test.com
private-user-id : UEa1_private@under.test.com
contact_URI : sip:UEa1_public_1@node.under.test.com
HOMENETWORK Domain : sip:under.test.com

[PARAMETER(TESTER)]

public-user-id(UEa2) : sip:UEa2_public_1@under.test.com
P-CSCFa1 : sip:p.a1.under.test.com

[ADDRESS]



UEa1(NUT)	:	3ffe:501:fff:1000::1000
Router(R1)	:	3ffe:501:fff:1000::1
P-CSCFa1	:	3ffe:501:fff:100::10
I-CSCFa1	:	3ffe:501:fff:100::20
S-CSCFa1	:	3ffe:501:fff:100::30
DNS	:	3ffe:501:fff:100::40
DHCP	:	3ffe:501:fff:100::50
UEa2	:	3ffe:501:fff:2000::1000
P-CSCFa2	:	3ffe:501:fff:200::10
I-CSCFa2	:	3ffe:501:fff:200::20
S-CSCFa2	:	3ffe:501:fff:200::30

[TOPOLOGY]

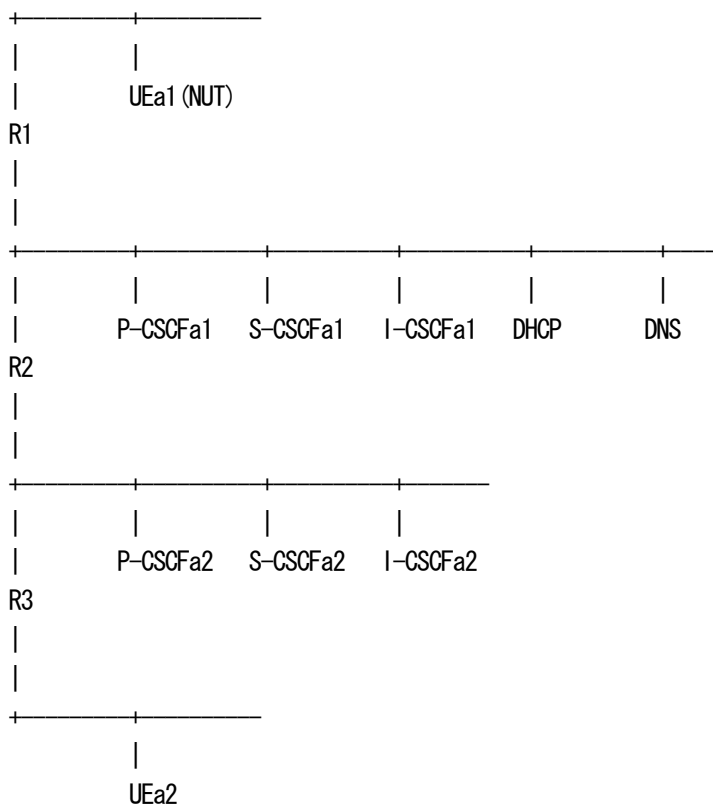

[INITIALIZATION]

UEa1(NUT) must be registered with the tester by executing the scenario "UE-INI-B-1-AKA".
For details of "UE-INI-B-1-AKA", refer to the profile "UE-RG-B-1-AKA".

[PROCEDURE]

Home Network

(NUT)

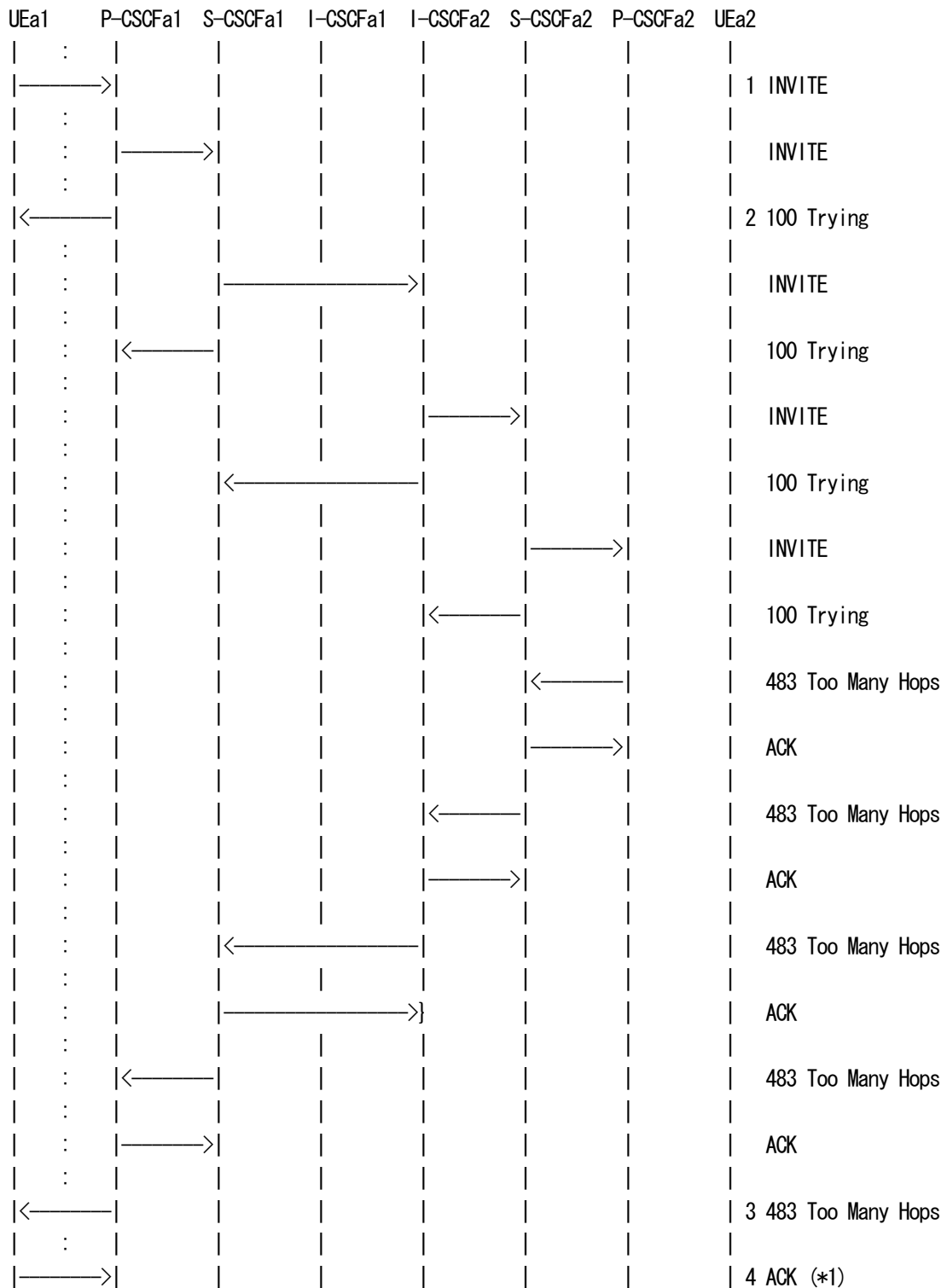



- 1 NUT sends INVITE
- 2 NUT receives 100 Trying
- 3 NUT receives 483 Too Many Hops
- 4 NUT sends ACK

=== Message example ===

As regards the message 1-2, please refer to the message 1-2 in UE-SE-B-1-AKA.

3. 483 Too Many Hops P-CSCF -> NUT

SIP/2.0 483 Too Many Hops

Via: SIP/2.0/UDP [3ffe:501:ffff:1000::1000]:1357;branch=z9hG4bK74bf9

From: <sip:UEa1_public_1@under.test.com>;tag=9fxced76sl

To: <sip:UEa2_public_1@under.test.com>;tag=314259

Call-ID: 3848276298220188511@under.test.com

CSeq: 1 INVITE

Content-Length: 0

4. ACK NUT -> P-CSCF

ACK sip:UEa2_public_1@under.test.com SIP/2.0

Via: SIP/2.0/UDP [3ffe:501:ffff:1000::1000]:1357;branch=z9hG4bK74bf9

Route: <sip:p.a1.under.test.com:10001;lr>,<sip:orig@s.a1.under.test.com;lr>

Max-Forwards: 70

From: <sip:UEa1_public_1@under.test.com>;tag=9fxced76sl

To: <sip:UEa2_public_1@under.test.com>;tag=314259

Call-ID: 3848276298220188511@under.test.com

CSeq: 1 ACK

Content-Length: 0

[OBSERVABLE RESULTS]

*1: 4 ACK from NUT to P-CSCF.

See generic_ACK-non2XX



4.7.17 UE-RR-B-17-AKA - Receiving 484 response

[NAME]

UE-RR-B-17-AKA - Receiving 484 response

[TARGET]

IMS User Equipment (NUT)

[PURPOSE]

To verify that the UEa1 properly process a 484 (Address Incomplete) response, and verify that the UEa1 properly creates an ACK request.

[REFERENCE]

TS24.229 A.2.1.4.1

[REQUIREMENT]

NONE

[PARAMETER(NUT)]

public-user-id : sip:UEa1_public_1@under.test.com
private-user-id : UEa1_private@under.test.com
contact_URI : sip:UEa1_public_1@node.under.test.com
HOMENETWORK Domain : sip:under.test.com

[PARAMETER(TESTER)]

public-user-id(UEa2) : sip:UEa2_public_1@under.test.com
P-CSCFa1 : sip:p.a1.under.test.com

[ADDRESS]

UEa1(NUT) : 3ffe:501:fff:1000::1000
Router(R1) : 3ffe:501:fff:1000::1
P-CSCFa1 : 3ffe:501:fff:100::10
I-CSCFa1 : 3ffe:501:fff:100::20
S-CSCFa1 : 3ffe:501:fff:100::30
DNS : 3ffe:501:fff:100::40
DHCP : 3ffe:501:fff:100::50



From: <sip:UEa1_public_1@under.test.com>;tag=9fxced76sl
To: <sip:UEa2_public_1@under.test.com>;tag=314259
Call-ID: 3848276298220188511@under.test.com
CSeq: 1 INVITE
Content-Length: 0

4. ACK NUT -> P-CSCF

ACK sip:UEa2_public_1@under.test.com SIP/2.0
Via: SIP/2.0/UDP [3ffe:501:ffff:1000::1000]:1357;branch=z9hG4bK74bf9
Route: <sip:p.a1.under.test.com:10001;lr>,<sip:orig@s.a1.under.test.com;lr>
Max-Forwards: 70
From: <sip:UEa1_public_1@under.test.com>;tag=9fxced76sl
To: <sip:UEa2_public_1@under.test.com>;tag=314259
Call-ID: 3848276298220188511@under.test.com
CSeq: 1 ACK
Content-Length: 0

[OBSERVABLE RESULTS]

*1: 4 ACK from NUT to P-CSCF.

See generic_ACK-non2XX

4.7.18 UE-RR-B-18-AKA - Receiving 485 response

[NAME]

UE-RR-B-18-AKA - Receiving 485 response

[TARGET]

IMS User Equipment (NUT)

[PURPOSE]

To verify that the UEa1 properly process a 485 (Ambiguous) response,
and verify that the UEa1 properly creates an ACK request.

[REFERENCE]

TS24.229 A.2.1.4.1



[REQUIREMENT]

NONE

[PARAMETER(NUT)]

public-user-id : sip:UEa1_public_1@under.test.com
 private-user-id : UEa1_private@under.test.com
 contact_URI : sip:UEa1_public_1@node.under.test.com
 HOMENETWORK Domain : sip:under.test.com

[PARAMETER(TESTER)]

public-user-id(UEa2) : sip:UEa2_public_1@under.test.com
 P-CSCFa1 : sip:p.a1.under.test.com

[ADDRESS]

UEa1(NUT) : 3ffe:501:fff:1000::1000
 Router(R1) : 3ffe:501:fff:1000::1
 P-CSCFa1 : 3ffe:501:fff:100::10
 I-CSCFa1 : 3ffe:501:fff:100::20
 S-CSCFa1 : 3ffe:501:fff:100::30
 DNS : 3ffe:501:fff:100::40
 DHCP : 3ffe:501:fff:100::50

UEa2 : 3ffe:501:fff:2000::1000
 P-CSCFa2 : 3ffe:501:fff:200::10
 I-CSCFa2 : 3ffe:501:fff:200::20
 S-CSCFa2 : 3ffe:501:fff:200::30

[TOPOLOGY]

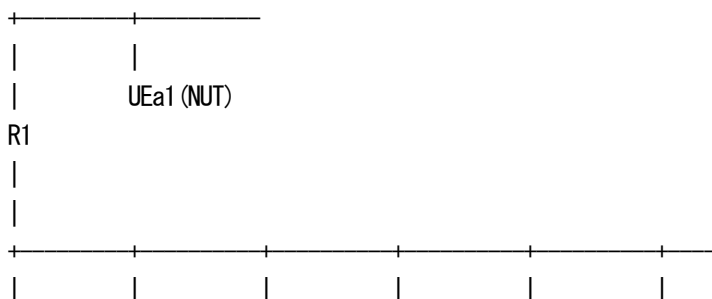



Max-Forwards: 70
From: <sip:UEa1_public_1@under.test.com>;tag=9fxced76sl
To: <sip:UEa2_public_1@under.test.com>;tag=314259
Call-ID: 3848276298220188511@under.test.com
CSeq: 1 ACK
Content-Length: 0

[OBSERVABLE RESULTS]

*1: 4 ACK from NUT to P-CSCF.

See generic_ACK-non2XX

4.7.19 UE-RR-B-19-AKA - Receiving 488 response

[NAME]

UE-RR-B-19-AKA - Receiving 488 response

[TARGET]

IMS User Equipment (NUT)

[PURPOSE]

To verify that the UEa1 properly process 488 (Not Acceptable Here) response, and verify that the UEa1 properly creates an ACK request.

[REFERENCE]

TS24.229 6.1.2
TS24.229 A.2.1.4.1

[REQUIREMENT]

NONE

[PARAMETER(NUT)]

public-user-id : sip:UEa1_public_1@under.test.com
private-user-id : UEa1_private@under.test.com
contact_URI : sip:UEa1_public_1@node.under.test.com



HOMENETWORK Domain : sip:under.test.com

[PARAMETER(TESTER)]

public-user-id(UEa2) : sip:UEa2_public_1@under.test.com
P-CSCFa1 : sip:p.a1.under.test.com
S-CSCFa1 : sip:s.a1.under.test.com

[ADDRESS]

UEa1(NUT) : 3ffe:501:fff:1000::1000
Router(R1) : 3ffe:501:fff:1000::1
P-CSCFa1 : 3ffe:501:fff:100::10
I-CSCFa1 : 3ffe:501:fff:100::20
S-CSCFa1 : 3ffe:501:fff:100::30
DNS : 3ffe:501:fff:100::40
DHCP : 3ffe:501:fff:100::50
UEa2 : 3ffe:501:fff:2000::1000
P-CSCFa2 : 3ffe:501:fff:200::10
I-CSCFa2 : 3ffe:501:fff:200::20
S-CSCFa2 : 3ffe:501:fff:200::30

[TOPOLOGY]

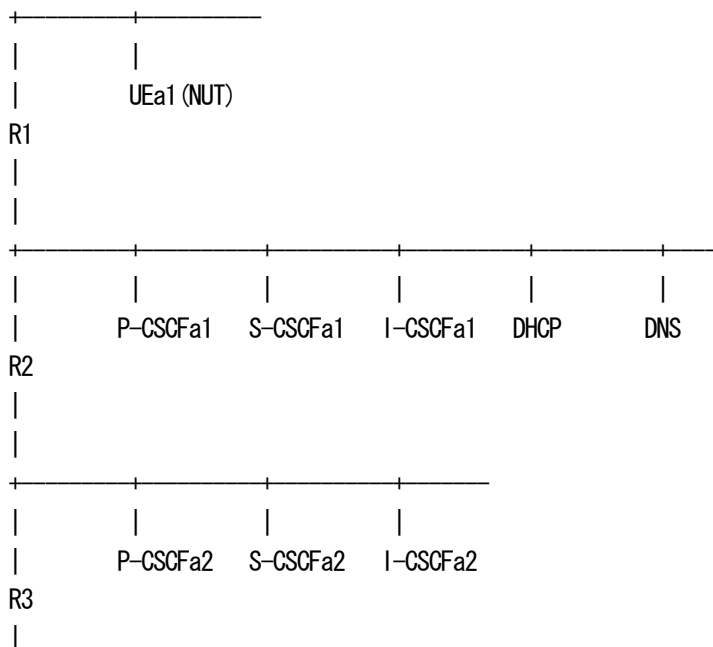

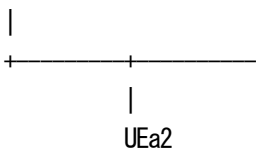

[INITIALIZATION]

UEa1(NUT) must be registered with the tester by executing the scenario "UE-INI-B-1-AKA".
 For details of "UE-INI-B-1-AKA", refer to the profile "UE-RG-B-1-AKA".

[PROCEDURE]

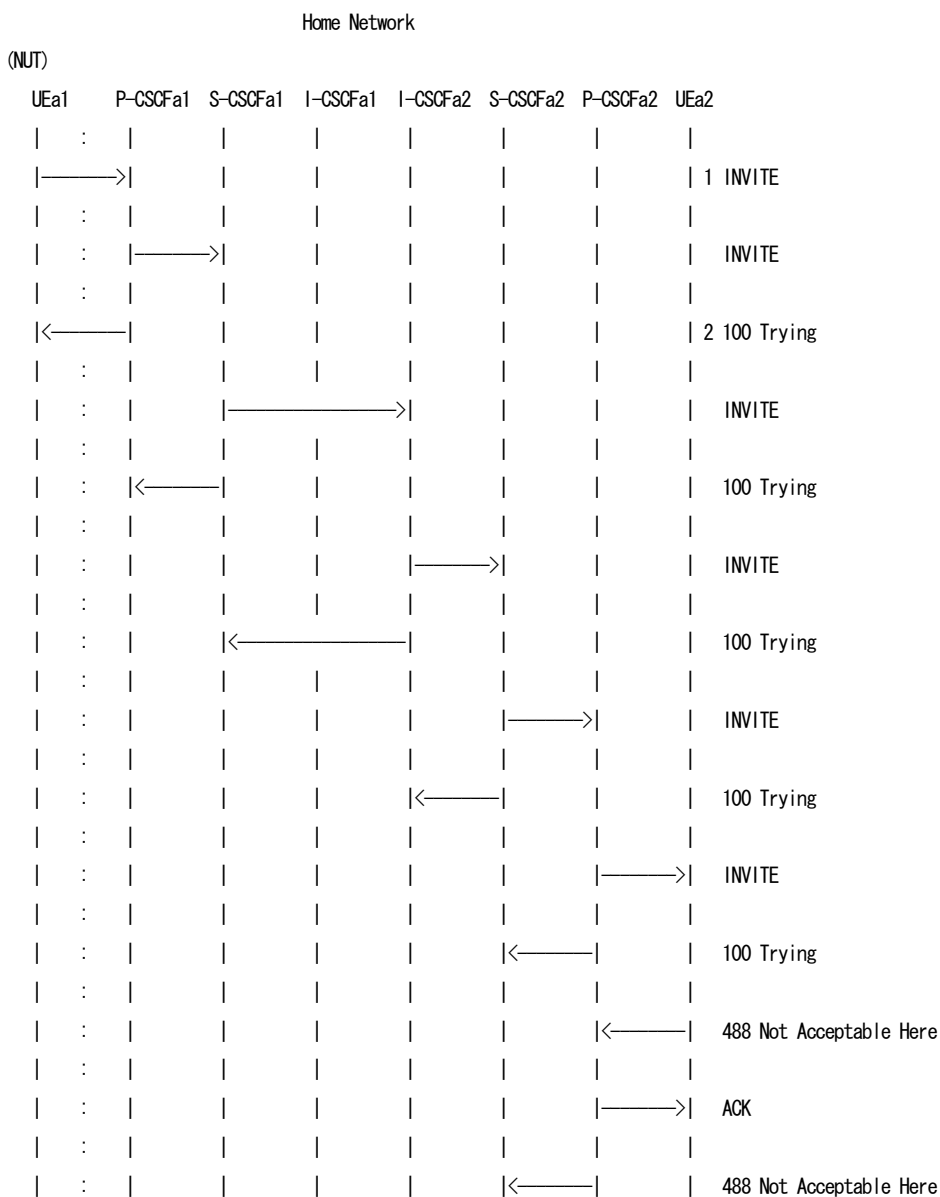



Route: <sip:p.a1.under.test.com:10001;lr>,<sip:orig@s.a1.under.test.com;lr>
Max-Forwards: 70
From: <sip:UEa1_public_1@under.test.com>;tag=9fxced76sl
To: <sip:UEa2_public_1@under.test.com>;tag=314259
Call-ID: 3848276298220188511@under.test.com
CSeq: 1 ACK
Content-Length: 0

[OBSERVABLE RESULTS]

*1: 4 ACK from NUT to P-CSCF.

See generic_ACK-non2XX

4.7.20 UE-RR-B-20-AKA - Receiving 501 response

[NAME]

UE-RR-B-20-AKA - Receiving 501 response

[TARGET]

IMS User Equipment (NUT)

[PURPOSE]

To verify that the UEa1 properly process a 501 (Not Implemented) response, and verify that the UEa1 properly creates an ACK request.

[REFERENCE]

TS24.229 A.2.1.4.1

[REQUIREMENT]

NONE

[PARAMETER(NUT)]

public-user-id	:	sip:UEa1_public_1@under.test.com
private-user-id	:	UEa1_private@under.test.com
contact_URI	:	sip:UEa1_public_1@node.under.test.com



HOMENETWORK Domain : sip:under.test.com

[PARAMETER(TESTER)]

public-user-id(UEa2) : sip:UEa2_public_1@under.test.com
P-CSCFa1 : sip:p.a1.under.test.com

[ADDRESS]

UEa1(NUT) : 3ffe:501:fff:1000::1000
Router(R1) : 3ffe:501:fff:1000::1
P-CSCFa1 : 3ffe:501:fff:100::10
I-CSCFa1 : 3ffe:501:fff:100::20
S-CSCFa1 : 3ffe:501:fff:100::30
DNS : 3ffe:501:fff:100::40
DHCP : 3ffe:501:fff:100::50

UEa2 : 3ffe:501:fff:2000::1000
P-CSCFa2 : 3ffe:501:fff:200::10
I-CSCFa2 : 3ffe:501:fff:200::20
S-CSCFa2 : 3ffe:501:fff:200::30

[TOPOLOGY]

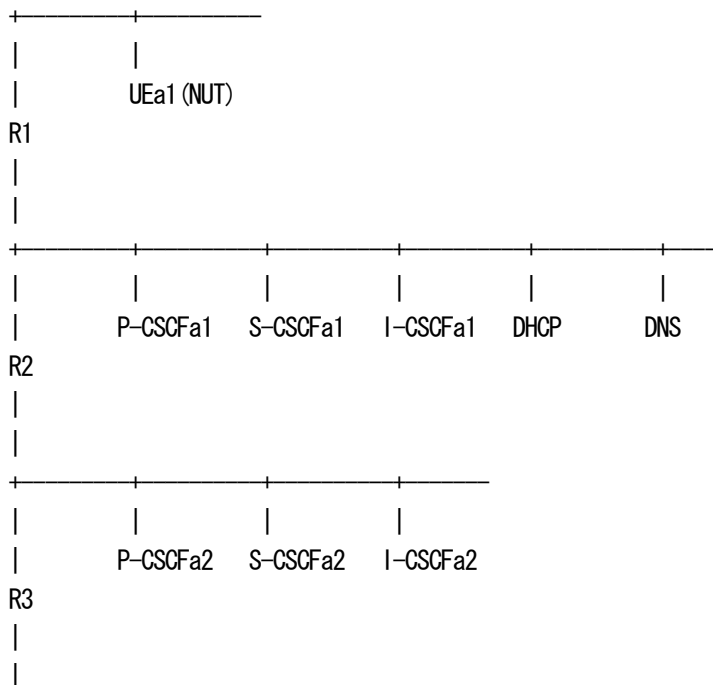

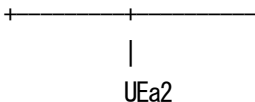

[INITIALIZATION]

UEa1(NUT) must be registered with the tester by executing the scenario "UE-INI-B-1-AKA".
 For details of "UE-INI-B-1-AKA", refer to the profile "UE-RG-B-1-AKA".

[PROCEDURE]

Home Network

(NUT)

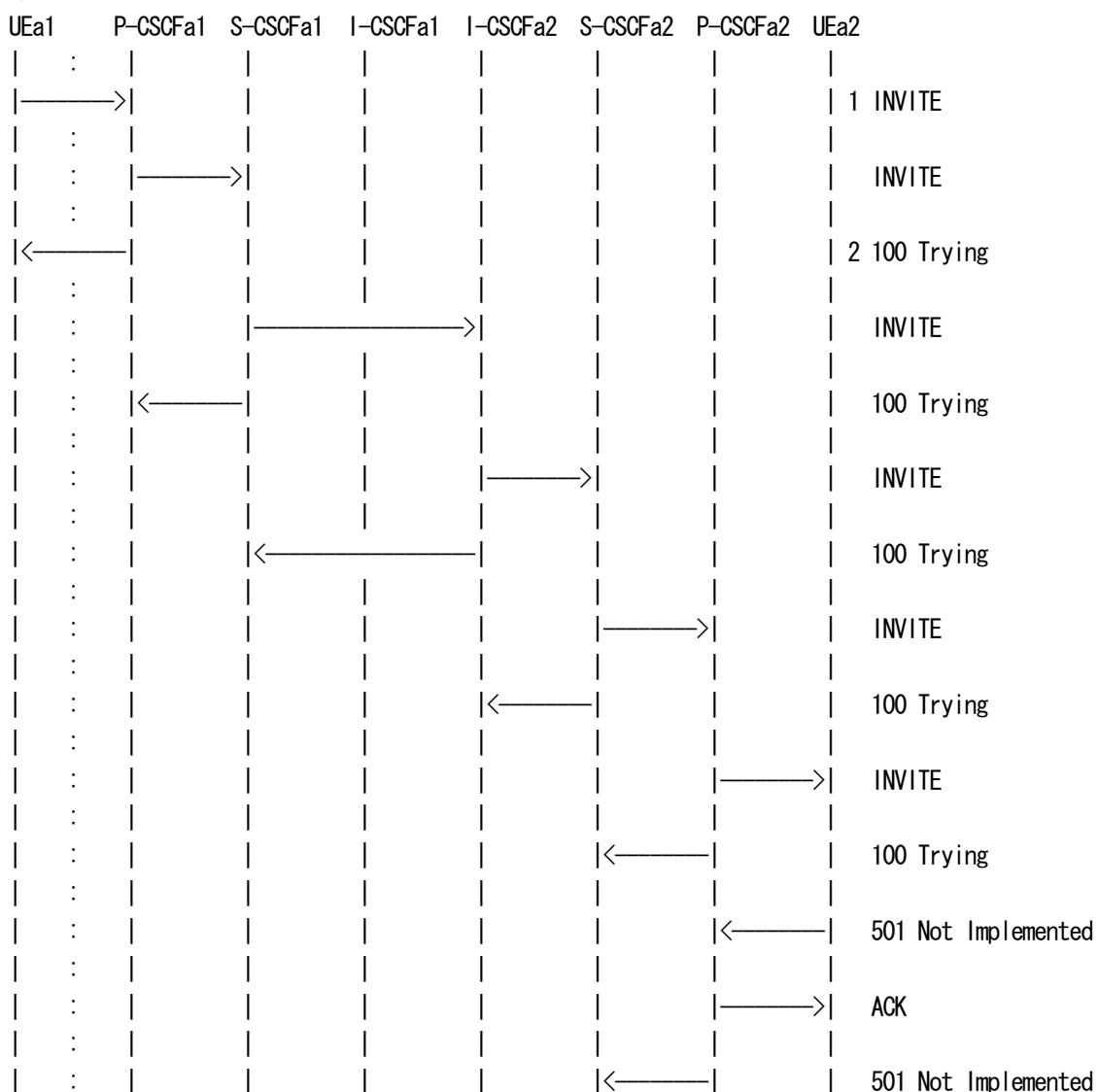

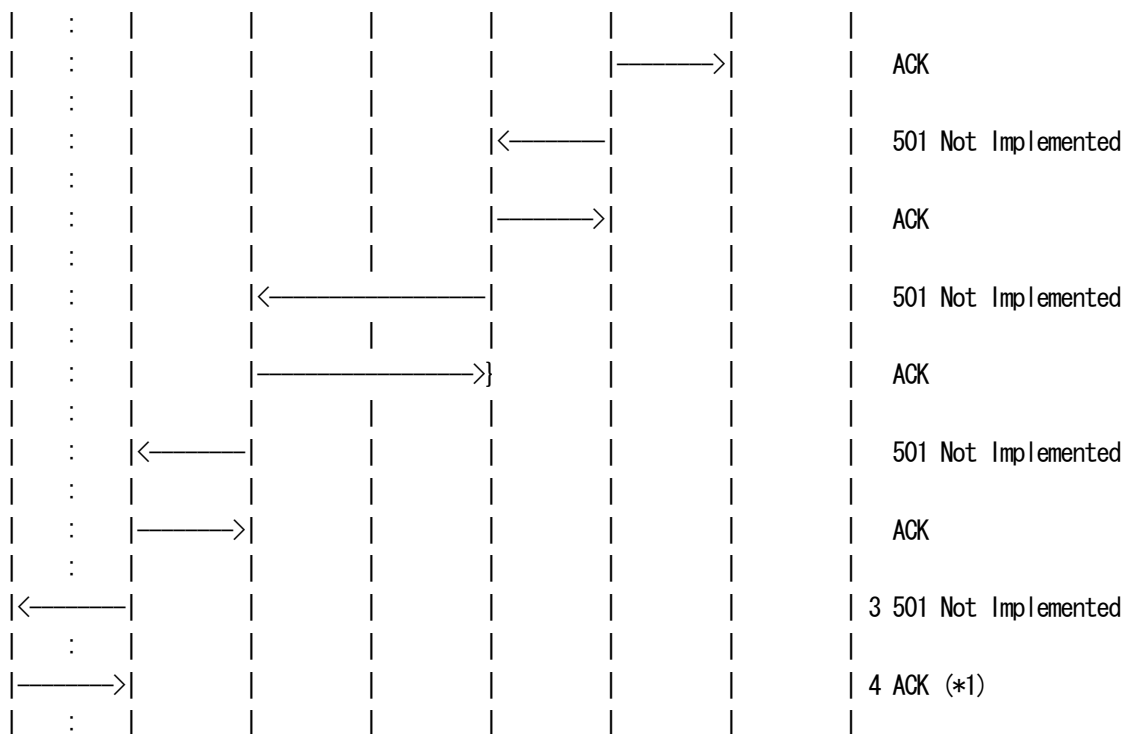

- 1 NUT sends INVITE
- 2 NUT receives 100 Trying
- 3 NUT receives 501 Not Implemented
- 4 NUT sends ACK

=== Message example ===

As regards the message 1-2, please refer to the message 1-2 in UE-SE-B-1-AKA.

3. 501 Not Implemented P-CSCF -> NUT
 SIP/2.0 501 Not Implemented
 Via: SIP/2.0/UDP [3ffe:501:ffff:1000::1000]:1357;branch=z9hG4bK74bf9
 From: <sip:UEa1_public_1@under.test.com>;tag=9fxced76sl
 To: <sip:UEa2_public_1@under.test.com>;tag=314259
 Call-ID: 3848276298220188511@under.test.com
 CSeq: 1 INVITE
 Content-Length: 0

4. ACK NUT -> P-CSCF
 ACK sip:UEa2_public_1@under.test.com SIP/2.0



Via: SIP/2.0/UDP [3ffe:501:ffff:1000::1000]:1357;branch=z9hG4bK74bf9
Route: <sip:p.a1.under.test.com:10001;lr>,<sip:orig@s.a1.under.test.com;lr>
Max-Forwards: 70
From: <sip:UEa1_public_1@under.test.com>;tag=9fxced76sl
To: <sip:UEa2_public_1@under.test.com>;tag=314259
Call-ID: 3848276298220188511@under.test.com
CSeq: 1 ACK
Content-Length: 0

[OBSERVABLE RESULTS]

*1: 4 ACK from NUT to P-CSCF.

See generic_ACK-non2XX

4.7.21 UE-RR-B-21-AKA - Receiving 502 response

[NAME]

UE-RR-B-21-AKA - Receiving 502 response

[TARGET]

IMS User Equipment (NUT)

[PURPOSE]

To verify that the UEa1 properly process a 502 (Bad Gateway) response, and verify that the UEa1 properly creates an ACK request.

[REFERENCE]

TS24.229 A.2.1.4.1

[REQUIREMENT]

NONE

[PARAMETER(NUT)]

public-user-id : sip:UEa1_public_1@under.test.com
private-user-id : UEa1_private@under.test.com



contact_URI : sip:UEa1_public_1@node.under.test.com
HOMENETWORK Domain : sip:under.test.com

[PARAMETER(TESTER)]

public-user-id(UEa2) : sip:UEa2_public_1@under.test.com
P-CSCFa1 : sip:p.a1.under.test.com

[ADDRESS]

UEa1(NUT) : 3ffe:501:fff:1000::1000
Router(R1) : 3ffe:501:fff:1000::1
P-CSCFa1 : 3ffe:501:fff:100::10
I-CSCFa1 : 3ffe:501:fff:100::20
S-CSCFa1 : 3ffe:501:fff:100::30
DNS : 3ffe:501:fff:100::40
DHCP : 3ffe:501:fff:100::50

UEa2 : 3ffe:501:fff:2000::1000
P-CSCFa2 : 3ffe:501:fff:200::10
I-CSCFa2 : 3ffe:501:fff:200::20
S-CSCFa2 : 3ffe:501:fff:200::30

[TOPOLOGY]

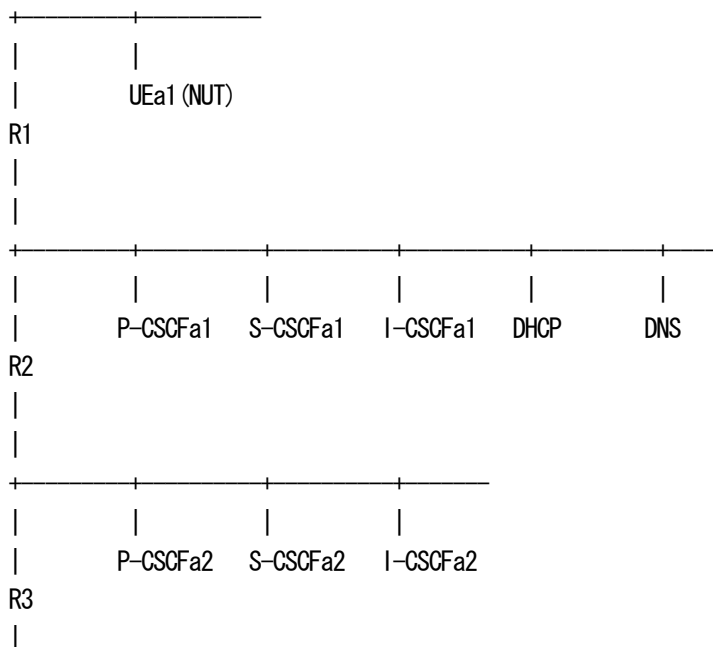



[INITIALIZATION]

UEa1(NUT) must be registered with the tester by executing the scenario "UE-INI-B-1-AKA".
For details of "UE-INI-B-1-AKA", refer to the profile "UE-RG-B-1-AKA".

[PROCEDURE]

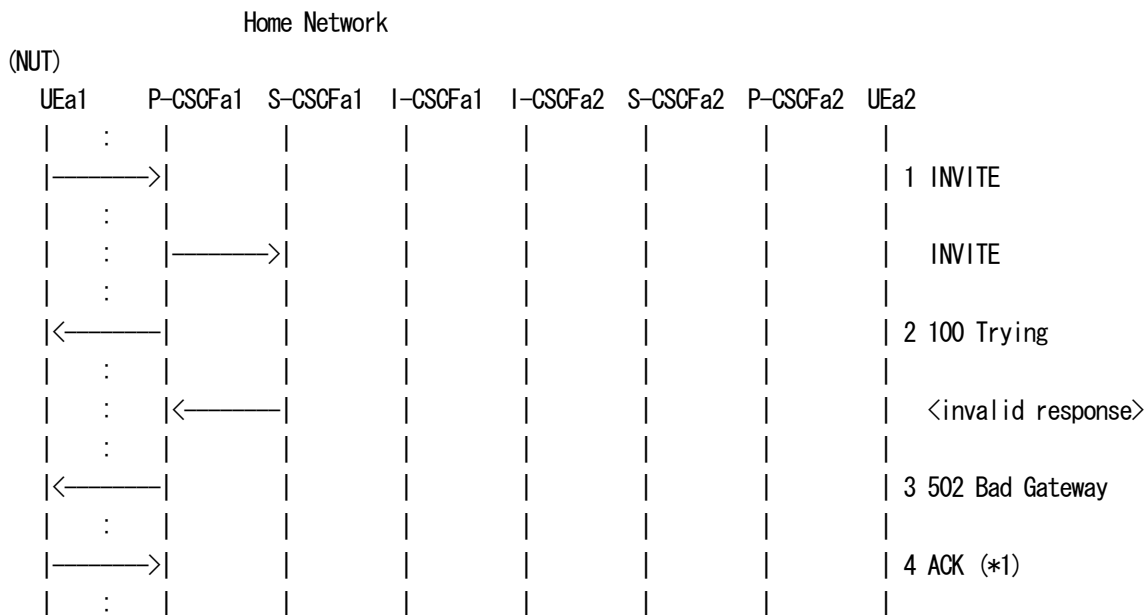

- 1 NUT sends INVITE
- 2 NUT receives 100 Trying
- 3 NUT receives 502 Bad Gateway
- 4 NUT sends ACK

=== Message example ===

As regards the message 1-2, please refer to the message 1-2 in UE-SE-B-1-AKA.

3. 502 Bad Gateway P-CSCF -> NUT
SIP/2.0 502 Bad Gateway
Via: SIP/2.0/UDP [3ffe:501:ffff:1000::1000]:1357;branch=z9hG4bK74bf9



From: <sip:UEa1_public_1@under.test.com>;tag=9fxced76sl
To: <sip:UEa2_public_1@under.test.com>;tag=314259
Call-ID: 3848276298220188511@under.test.com
CSeq: 1 INVITE
Content-Length: 0

4. ACK NUT -> P-CSCF

ACK sip:UEa2_public_1@under.test.com SIP/2.0
Via: SIP/2.0/UDP [3ffe:501:ffff:1000::1000]:1357;branch=z9hG4bK74bf9
Route: <sip:p.a1.under.test.com:10001;lr>,<sip:orig@s.a1.under.test.com;lr>
Max-Forwards: 70
From: <sip:UEa1_public_1@under.test.com>;tag=9fxced76sl
To: <sip:UEa2_public_1@under.test.com>;tag=314259
Call-ID: 3848276298220188511@under.test.com
CSeq: 1 ACK
Content-Length: 0

[OBSERVABLE RESULTS]

*1: 4 ACK from NUT to P-CSCF.

See generic_ACK-non2XX

4.7.22 UE-RR-B-22-AKA - Receiving 505 response

[NAME]

UE-RR-B-22-AKA - Receiving 505 response

[TARGET]

IMS User Equipment (NUT)

[PURPOSE]

To verify that the UEa1 properly process a 505 (Version Not Supported) response, and verify that the UEa1 properly creates an ACK request.

[REFERENCE]

TS24.229 A.2.1.4.1



[REQUIREMENT]

NONE

[PARAMETER(NUT)]

public-user-id : sip:UEa1_public_1@under.test.com
 private-user-id : UEa1_private@under.test.com
 contact_URI : sip:UEa1_public_1@node.under.test.com
 HOMENETWORK Domain : sip:under.test.com

[PARAMETER(TESTER)]

public-user-id(UEa2) : sip:UEa2_public_1@under.test.com
 P-CSCFa1 : sip:p.a1.under.test.com

[ADDRESS]

UEa1(NUT) : 3ffe:501:fff:1000::1000
 Router(R1) : 3ffe:501:fff:1000::1
 P-CSCFa1 : 3ffe:501:fff:100::10
 I-CSCFa1 : 3ffe:501:fff:100::20
 S-CSCFa1 : 3ffe:501:fff:100::30
 DNS : 3ffe:501:fff:100::40
 DHCP : 3ffe:501:fff:100::50

UEa2 : 3ffe:501:fff:2000::1000
 P-CSCFa2 : 3ffe:501:fff:200::10
 I-CSCFa2 : 3ffe:501:fff:200::20
 S-CSCFa2 : 3ffe:501:fff:200::30

[TOPOLOGY]

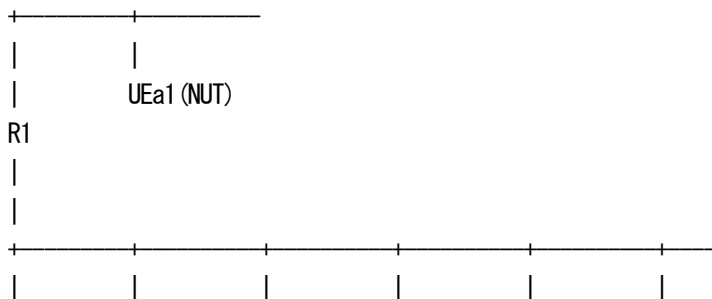

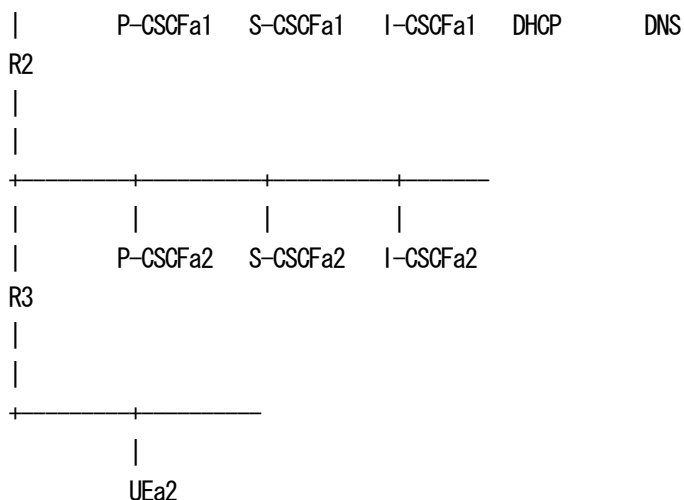

[INITIALIZATION]

UEa1(NUT) must be registered with the tester by executing the scenario "UE-INI-B-1-AKA".
 For details of "UE-INI-B-1-AKA", refer to the profile "UE-RG-B-1-AKA".

[PROCEDURE]

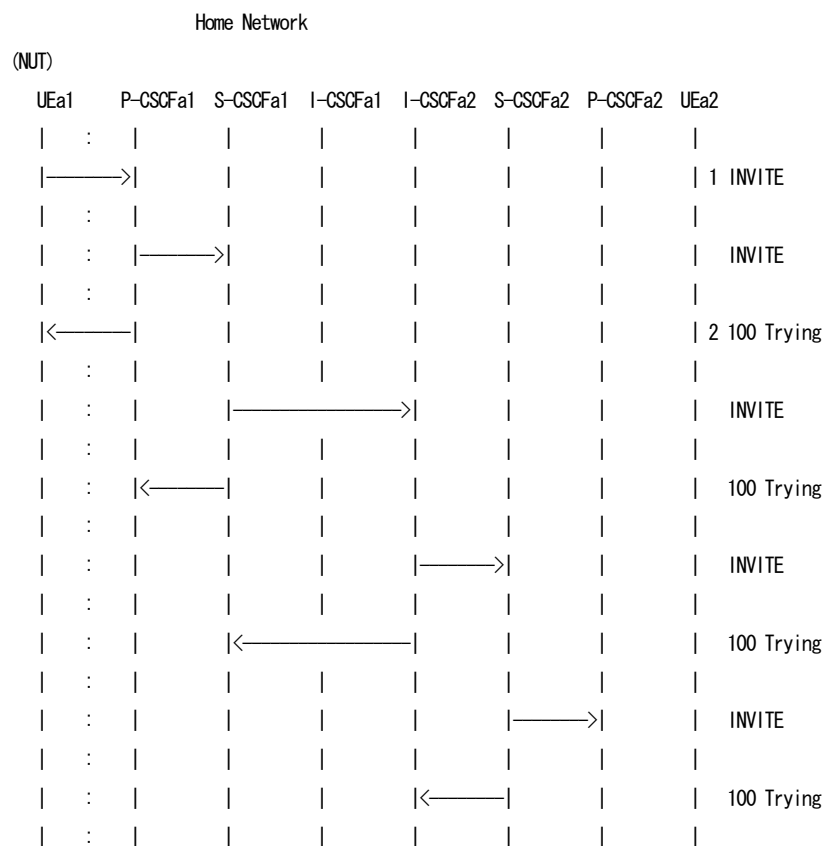



From: <sip:UEa1_public_1@under.test.com>;tag=9fxced76sl
To: <sip:UEa2_public_1@under.test.com>;tag=314259
Call-ID: 3848276298220188511@under.test.com
CSeq: 1 INVITE
Content-Length: 0

4. ACK NUT -> P-CSCF

ACK sip:UEa2_public_1@under.test.com SIP/2.0
Via: SIP/2.0/UDP [3ffe:501:ffff:1000::1000]:1357;branch=z9hG4bK74bf9
Route: <sip:p.a1.under.test.com:10001;lr>,<sip:orig@s.a1.under.test.com;lr>
Max-Forwards: 70
From: <sip:UEa1_public_1@under.test.com>;tag=9fxced76sl
To: <sip:UEa2_public_1@under.test.com>;tag=314259
Call-ID: 3848276298220188511@under.test.com
CSeq: 1 ACK
Content-Length: 0

[OBSERVABLE RESULTS]

*1: 4 ACK from NUT to P-CSCF.

See generic_ACK-non2XX

4.7.23 UE-RR-B-23-AKA - Receiving 513 response

[NAME]

UE-RR-B-23-AKA - Receiving 513 response

[TARGET]

IMS User Equipment (NUT)

[PURPOSE]

To verify that the UEa1 properly process a 513 (Message Too Large) response, and verify that the UEa1 properly creates an ACK request.

[REFERENCE]

TS24.229 A.2.1.4.1



[REQUIREMENT]

NONE

[PARAMETER(NUT)]

public-user-id : sip:UEa1_public_1@under.test.com
private-user-id : UEa1_private@under.test.com
contact_URI : sip:UEa1_public_1@node.under.test.com
HOMENETWORK Domain : sip:under.test.com

[PARAMETER(TESTER)]

public-user-id(UEa2) : sip:UEa2_public_1@under.test.com
P-CSCFa1 : sip:p.a1.under.test.com

[ADDRESS]

UEa1(NUT) : 3ffe:501:fff:1000::1000
Router(R1) : 3ffe:501:fff:1000::1
P-CSCFa1 : 3ffe:501:fff:100::10
I-CSCFa1 : 3ffe:501:fff:100::20
S-CSCFa1 : 3ffe:501:fff:100::30
DNS : 3ffe:501:fff:100::40
DHCP : 3ffe:501:fff:100::50

UEa2 : 3ffe:501:fff:2000::1000
P-CSCFa2 : 3ffe:501:fff:200::10
I-CSCFa2 : 3ffe:501:fff:200::20
S-CSCFa2 : 3ffe:501:fff:200::30

[TOPOLOGY]

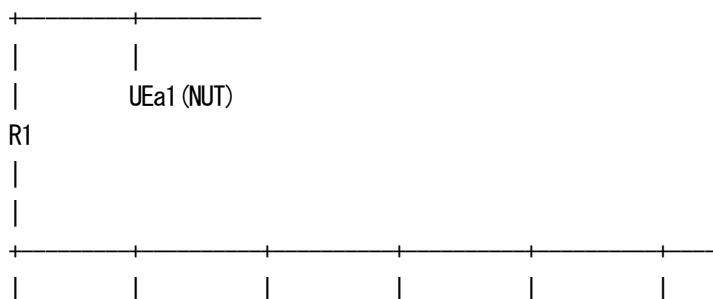

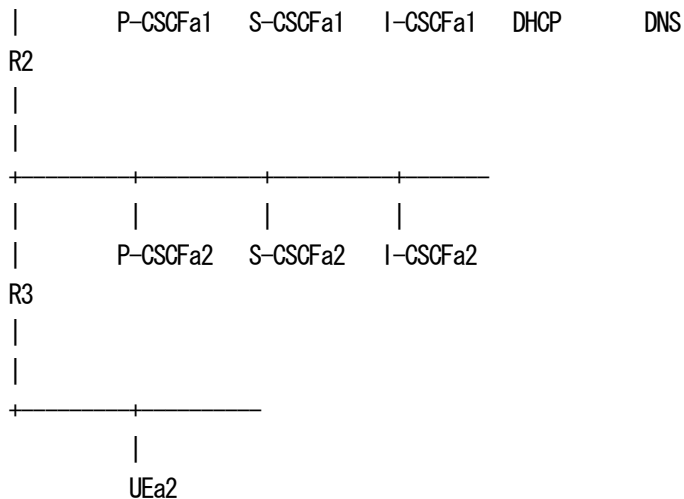

[INITIALIZATION]

UEa1(NUT) must be registered with the tester by executing the scenario "UE-INI-B-1-AKA".
 For details of "UE-INI-B-1-AKA", refer to the profile "UE-RG-B-1-AKA".

[PROCEDURE]

Home Network

(NUT)

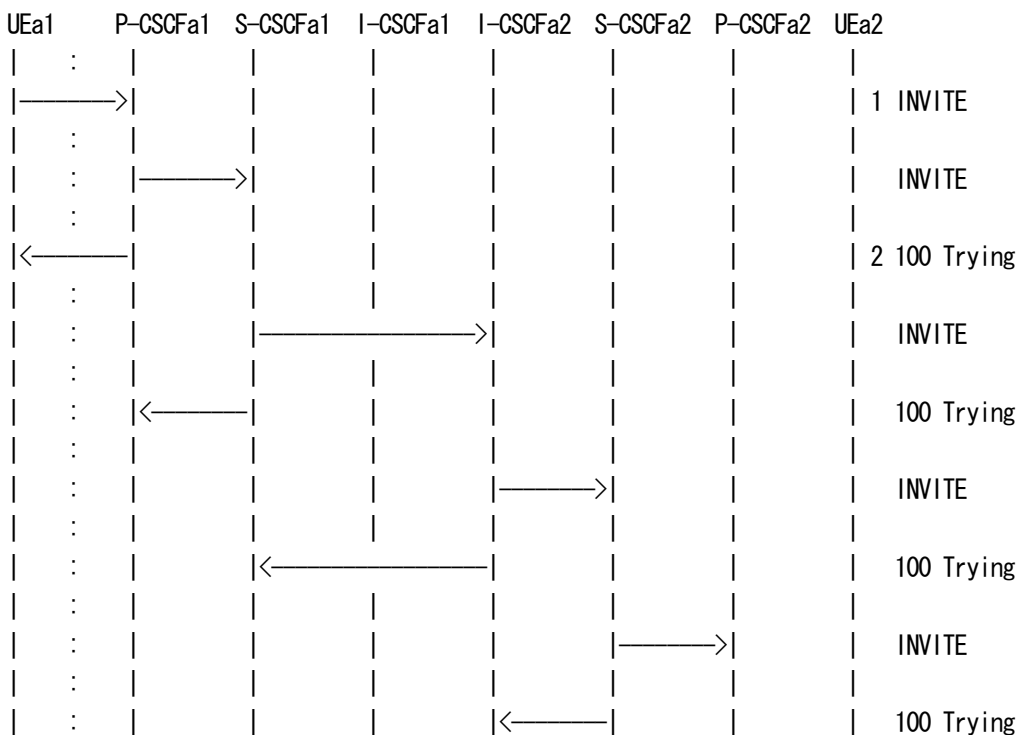

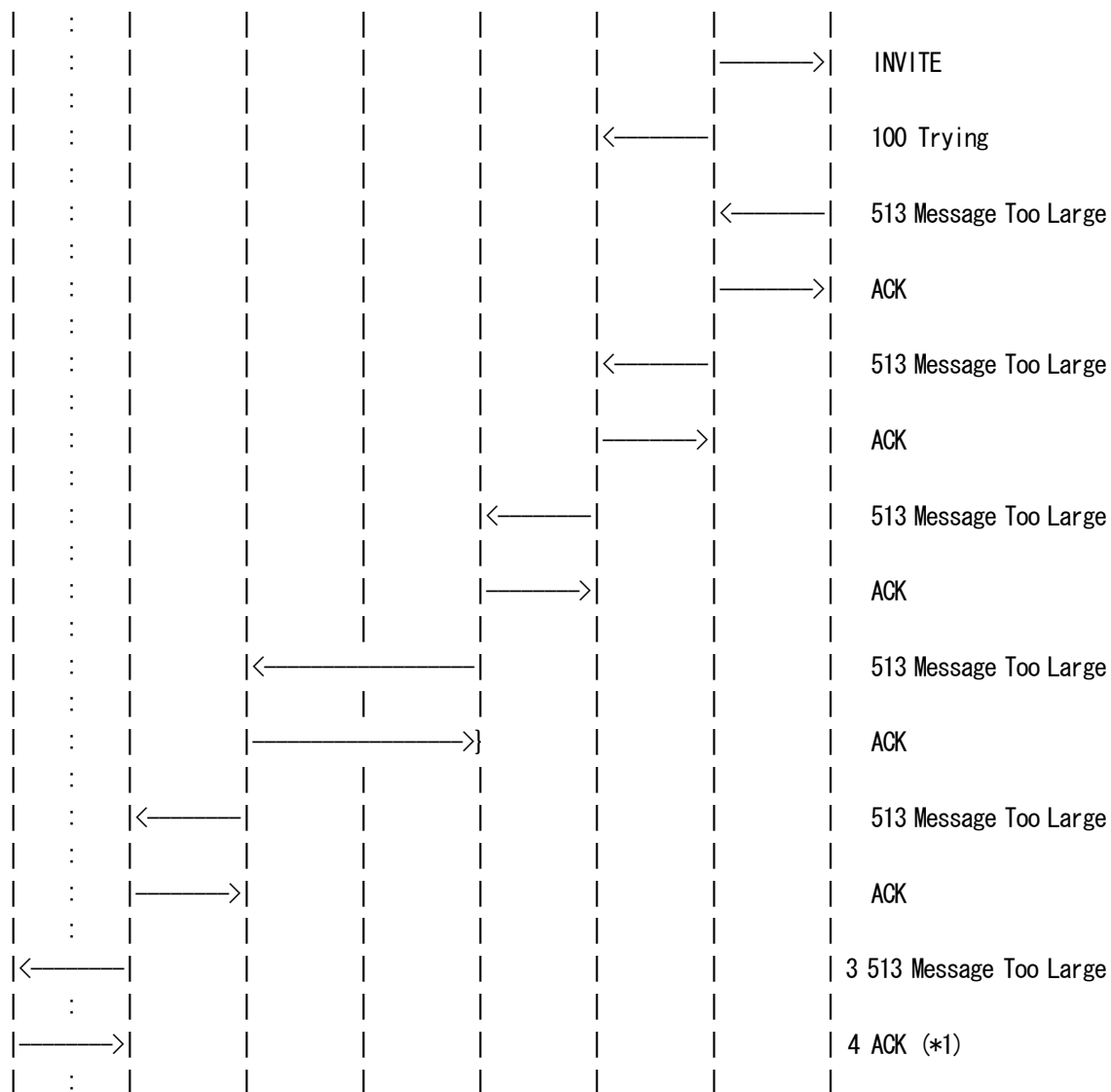

- 1 NUT sends INVITE
- 2 NUT receives 100 Trying
- 3 NUT receives 513 Message Too Large
- 4 NUT sends ACK

=== Message example ===

As regards the message 1-2, please refer to the message 1-2 in UE-SE-B-1-AKA.

3. 513 Message Too Large P-CSCF -> NUT
SIP/2.0 513 Message Too Large



Via: SIP/2.0/UDP [3ffe:501:ffff:1000::1000]:1357;branch=z9hG4bK74bf9
From: <sip:UEa1_public_1@under.test.com>;tag=9fxced76sl
To: <sip:UEa2_public_1@under.test.com>;tag=314259
Call-ID: 3848276298220188511@under.test.com
CSeq: 1 INVITE
Content-Length: 0

4. ACK NUT -> P-CSCF

ACK sip:UEa2_public_1@under.test.com SIP/2.0
Via: SIP/2.0/UDP [3ffe:501:ffff:1000::1000]:1357;branch=z9hG4bK74bf9
Route: <sip:p.a1.under.test.com:10001;lr>, <sip:orig@s.a1.under.test.com;lr>
Max-Forwards: 70
From: <sip:UEa1_public_1@under.test.com>;tag=9fxced76sl
To: <sip:UEa2_public_1@under.test.com>;tag=314259
Call-ID: 3848276298220188511@under.test.com
CSeq: 1 ACK
Content-Length: 0

[OBSERVABLE RESULTS]

*1: 4 ACK from NUT to P-CSCF.

See generic_ACK-non2XX

4.7.24 UE-RR-B-24-AKA - Receiving 600 response

[NAME]

UE-RR-B-24-AKA - Receiving 600 response

[TARGET]

IMS User Equipment (NUT)

[PURPOSE]

To verify that the UEa1 properly process a 600 (Busy Everywhere) response, and verify that the UEa1 properly creates an ACK request.

[REFERENCE]



TS24.229 A.2.1.4.1

[REQUIREMENT]
NONE

[PARAMETER(NUT)]

public-user-id	:	sip:UEa1_public_1@under.test.com
private-user-id	:	UEa1_private@under.test.com
contact_URI	:	sip:UEa1_public_1@node.under.test.com
HOMENETWORK Domain	:	sip:under.test.com

[PARAMETER(TESTER)]

public-user-id(UEa2)	:	sip:UEa2_public_1@under.test.com
P-CSCFa1	:	sip:p.a1.under.test.com

[ADDRESS]

UEa1(NUT)	:	3ffe:501:fff:1000::1000
Router(R1)	:	3ffe:501:fff:1000::1
P-CSCFa1	:	3ffe:501:fff:100::10
I-CSCFa1	:	3ffe:501:fff:100::20
S-CSCFa1	:	3ffe:501:fff:100::30
DNS	:	3ffe:501:fff:100::40
DHCP	:	3ffe:501:fff:100::50

UEa2	:	3ffe:501:fff:2000::1000
P-CSCFa2	:	3ffe:501:fff:200::10
I-CSCFa2	:	3ffe:501:fff:200::20
S-CSCFa2	:	3ffe:501:fff:200::30

[TOPOLOGY]

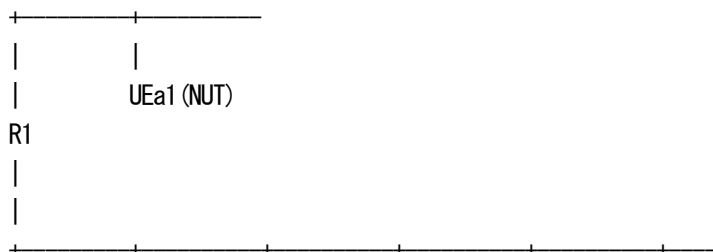

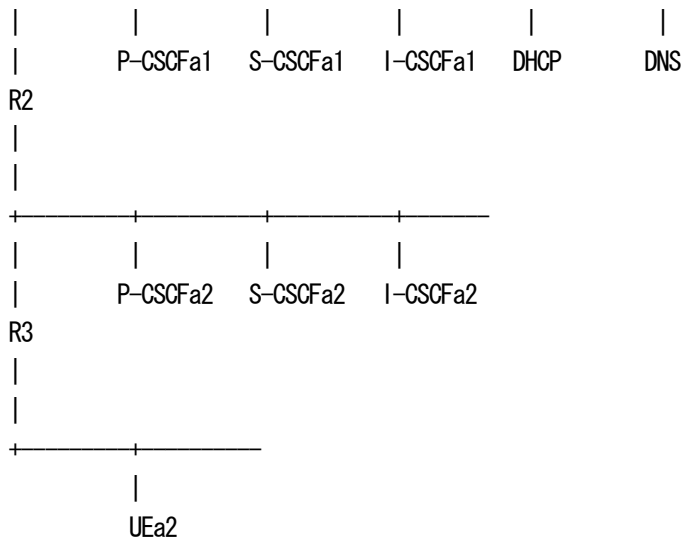

[INITIALIZATION]

UEa1(NUT) must be registered with the tester by executing the scenario "UE-INI-B-1-AKA".
 For details of "UE-INI-B-1-AKA", refer to the profile "UE-RG-B-1-AKA".

[PROCEDURE]

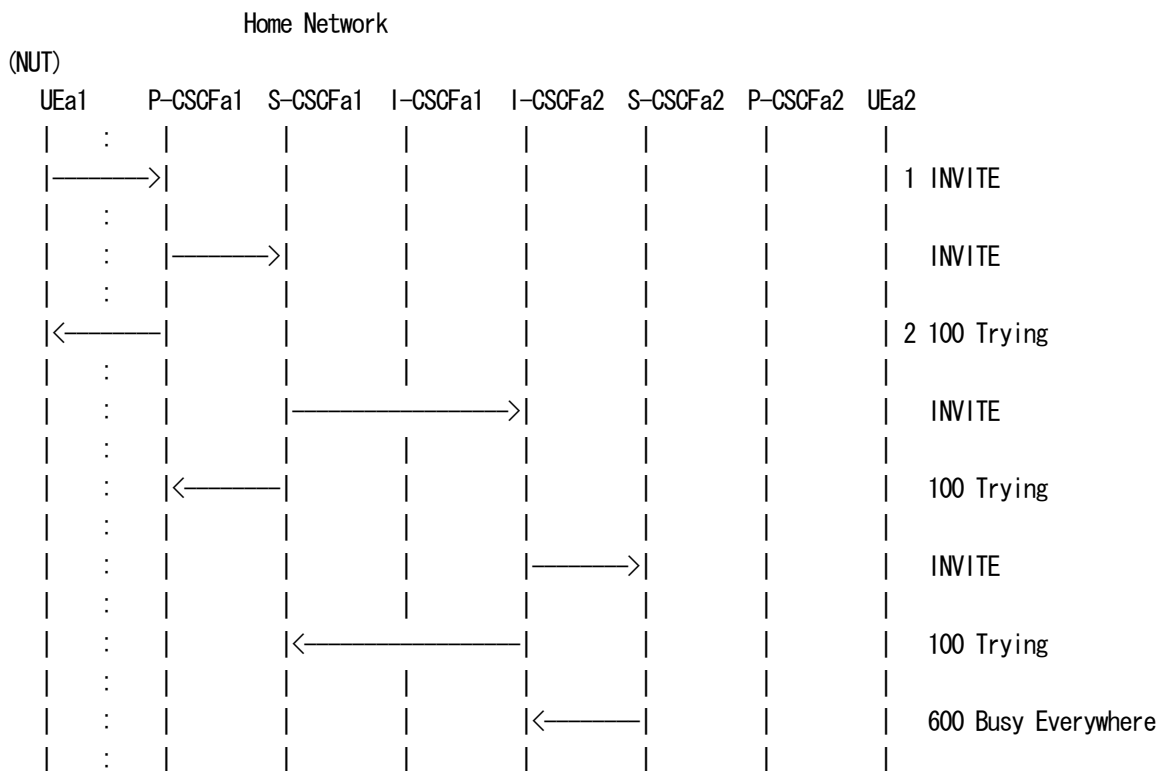

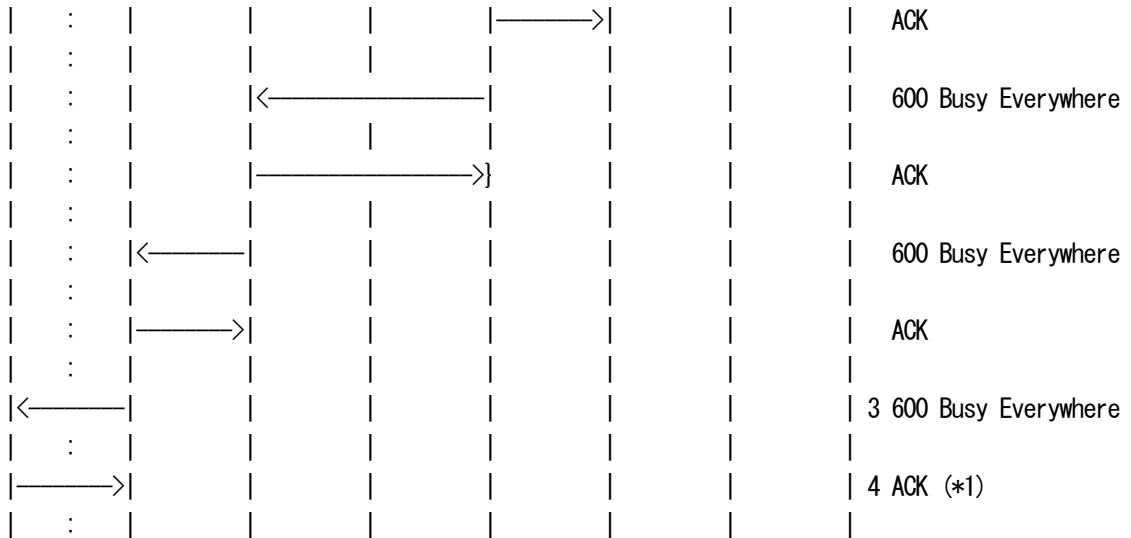

- 1 NUT sends INVITE
- 2 NUT receives 100 Trying
- 3 NUT receives 600 Busy Everywhere
- 4 NUT sends ACK

=== Message example ===

As regards the message 1-2, please refer to the message 1-2 in UE-SE-B-1-AKA.

3. 600 Busy Everywhere P-CSCF -> NUT
 SIP/2.0 600 Busy Everywhere
 Via: SIP/2.0/UDP [3ffe:501:ffff:1000::1000]:1357;branch=z9hG4bK74bf9
 From: <sip:UEa1_public_1@under.test.com>;tag=9fxced76sl
 To: <sip:UEa2_public_1@under.test.com>;tag=314259
 Call-ID: 3848276298220188511@under.test.com
 CSeq: 1 INVITE
 Content-Length: 0

4. ACK NUT -> P-CSCF
 ACK sip:UEa2_public_1@under.test.com SIP/2.0
 Via: SIP/2.0/UDP [3ffe:501:ffff:1000::1000]:1357;branch=z9hG4bK74bf9
 Route: <sip:p.a1.under.test.com:10001;lr>,<sip:orig@s.a1.under.test.com;lr>
 Max-Forwards: 70
 From: <sip:UEa1_public_1@under.test.com>;tag=9fxced76sl
 To: <sip:UEa2_public_1@under.test.com>;tag=314259



Call-ID: 3848276298220188511@under.test.com

CSeq: 1 ACK

Content-Length: 0

[OBSERVABLE RESULTS]

*1: 4 ACK from NUT to P-CSCF.

See generic_ACK-non2XX

4.7.25 UE-RR-B-25-AKA - Receiving 603 response

[NAME]

UE-RR-B-25-AKA - Receiving 603 response

[TARGET]

IMS User Equipment (NUT)

[PURPOSE]

To verify that the UEa1 properly process a 603 (Decline) response, and verify that the UEa1 properly creates an ACK request.

[REFERENCE]

TS24.229 A.2.1.4.1

[REQUIREMENT]

NONE

[PARAMETER(NUT)]

public-user-id	:	sip:UEa1_public_1@under.test.com
private-user-id	:	UEa1_private@under.test.com
contact_URI	:	sip:UEa1_public_1@node.under.test.com
HOMENETWORK Domain	:	sip:under.test.com

[PARAMETER(TESTER)]



public-user-id(UEa2) : sip:UEa2_public_1@under.test.com
P-CSCFa1 : sip:p.a1.under.test.com

[ADDRESS]

UEa1(NUT) : 3ffe:501:ffff:1000::1000
Router(R1) : 3ffe:501:ffff:1000::1
P-CSCFa1 : 3ffe:501:ffff:100::10
I-CSCFa1 : 3ffe:501:ffff:100::20
S-CSCFa1 : 3ffe:501:ffff:100::30
DNS : 3ffe:501:ffff:100::40
DHCP : 3ffe:501:ffff:100::50

UEa2 : 3ffe:501:ffff:2000::1000
P-CSCFa2 : 3ffe:501:ffff:200::10
I-CSCFa2 : 3ffe:501:ffff:200::20
S-CSCFa2 : 3ffe:501:ffff:200::30

[TOPOLOGY]

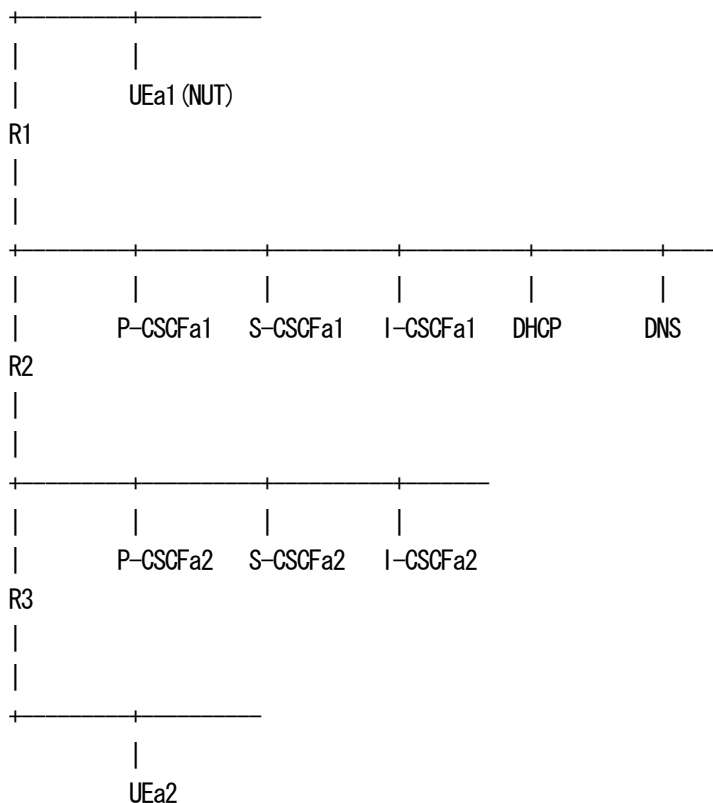



[INITIALIZATION]

UEa1(NUT) must be registered with the tester by executing the scenario "UE-INI-B-1-AKA".

For details of "UE-INI-B-1-AKA", refer to the profile "UE-RG-B-1-AKA".

[PROCEDURE]

Home Network

(NUT)

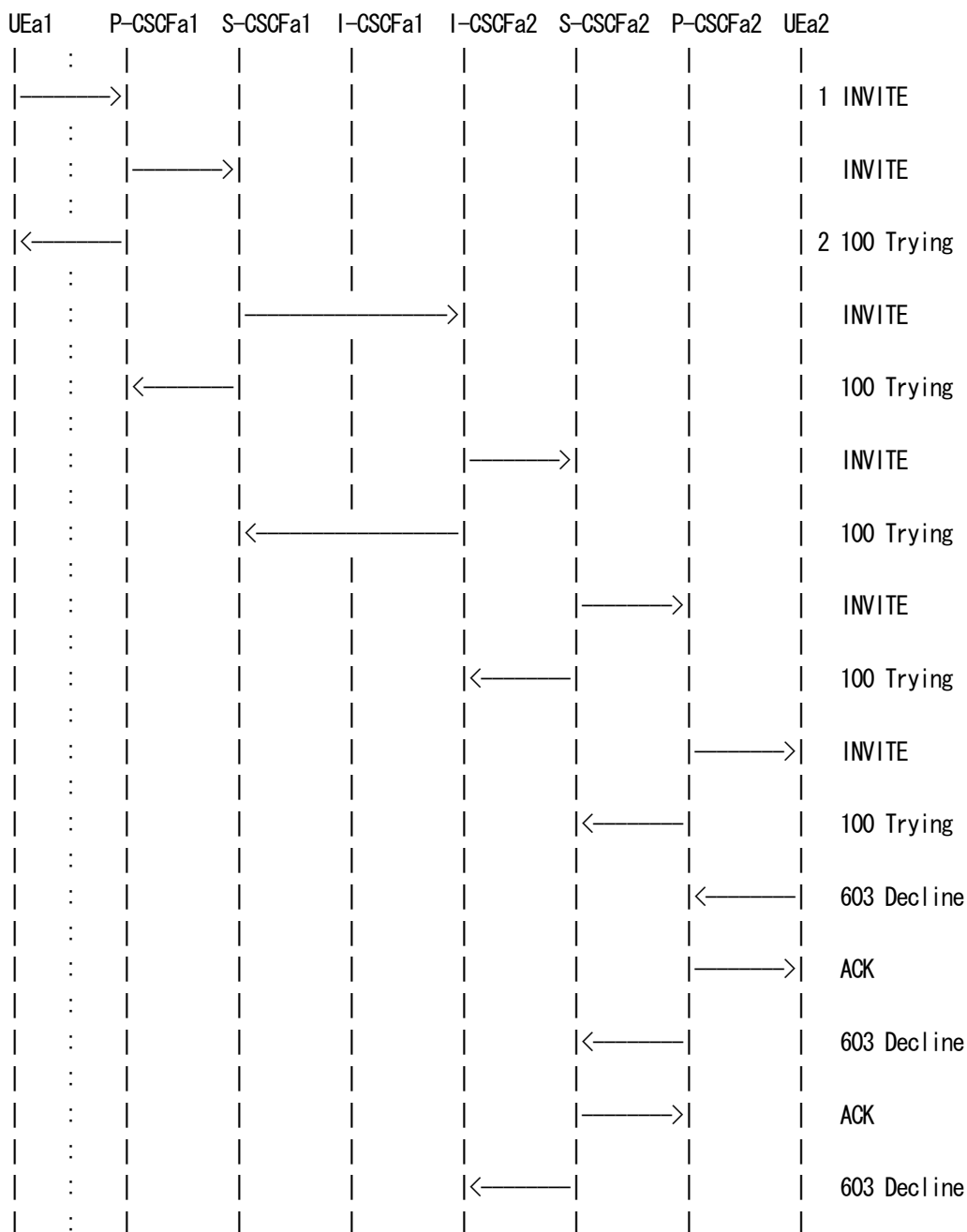



Call-ID: 3848276298220188511@under.test.com

CSeq: 1 ACK

Content-Length: 0

[OBSERVABLE RESULTS]

*1: 4 ACK from NUT to P-CSCF.

See generic_ACK-non2XX

4.7.26 UE-RR-B-26-AKA - Receiving 604 response

[NAME]

UE-RR-B-26-AKA - Receiving 604 response

[TARGET]

IMS User Equipment (NUT)

[PURPOSE]

To verify that the UEa1 properly process a 604 (Does not exist anywhere) response, and verify that the UEa1 properly creates an ACK request.

[REFERENCE]

TS24.229 A.2.1.4.1

[REQUIREMENT]

NONE

[PARAMETER(NUT)]

public-user-id	:	sip:UEa1_public_1@under.test.com
private-user-id	:	UEa1_private@under.test.com
contact_URI	:	sip:UEa1_public_1@node.under.test.com
HOMENETWORK Domain	:	sip:under.test.com

[PARAMETER(TESTER)]



public-user-id(UEa2) : sip:UEa2_public_1@under.test.com
P-CSCFa1 : sip:p.a1.under.test.com

[ADDRESS]

UEa1(NUT) : 3ffe:501:ffff:1000::1000
Router(R1) : 3ffe:501:ffff:1000::1
P-CSCFa1 : 3ffe:501:ffff:100::10
I-CSCFa1 : 3ffe:501:ffff:100::20
S-CSCFa1 : 3ffe:501:ffff:100::30
DNS : 3ffe:501:ffff:100::40
DHCP : 3ffe:501:ffff:100::50

UEa2 : 3ffe:501:ffff:2000::1000
P-CSCFa2 : 3ffe:501:ffff:200::10
I-CSCFa2 : 3ffe:501:ffff:200::20
S-CSCFa2 : 3ffe:501:ffff:200::30

[TOPOLOGY]

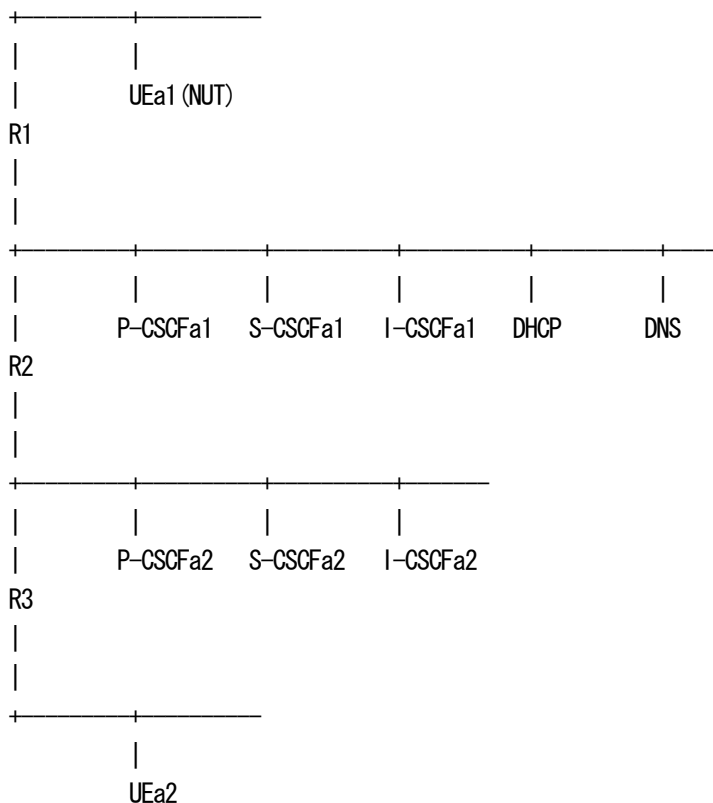



[INITIALIZATION]

UEa1(NUT) must be registered with the tester by executing the scenario "UE-INI-B-1-AKA".

For details of "UE-INI-B-1-AKA", refer to the profile "UE-RG-B-1-AKA".

[PROCEDURE]

Home Network

(NUT)

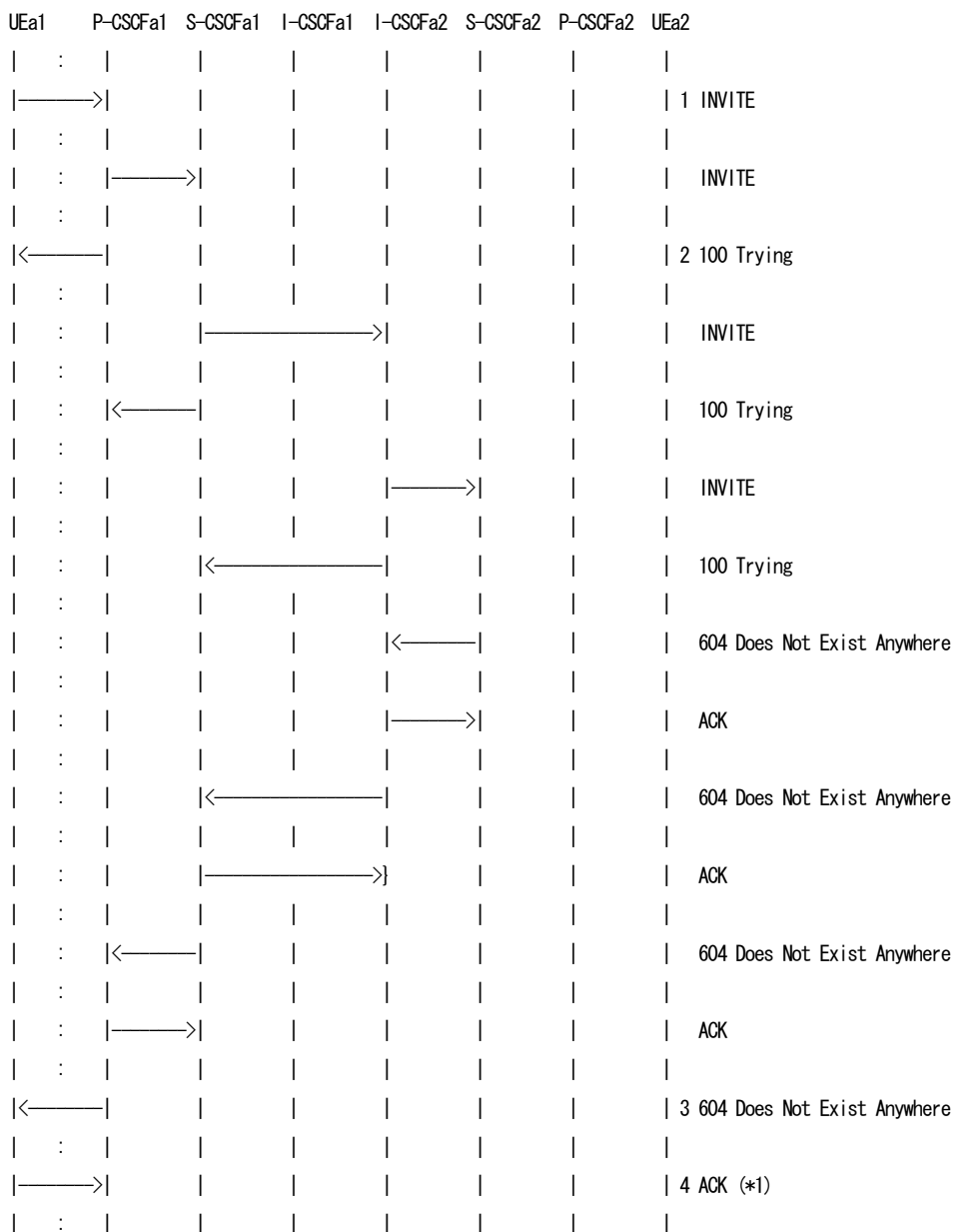

1 NUT sends INVITE



- 2 NUT receives 100 Trying
- 3 NUT receives 604 Does not exist anywhere
- 4 NUT sends ACK

=== Message example ===

As regards the message 1-2, please refer to the message 1-2 in UE-SE-B-1-AKA.

3. 604 Does Not Exist Anywhere P-CSCF -> NUT

SIP/2.0 604 Does Not Exist Anywhere

Via: SIP/2.0/UDP [3ffe:501:ffff:1000::1000]:1357;branch=z9hG4bK74bf9

From: <sip:UEa1_public_1@under.test.com>;tag=9fxced76sl

To: <sip:UEa2_public_1@under.test.com>;tag=314259

Call-ID: 3848276298220188511@under.test.com

CSeq: 1 INVITE

Content-Length: 0

4. ACK NUT -> P-CSCF

ACK sip:UEa2_public_1@under.test.com SIP/2.0

Via: SIP/2.0/UDP [3ffe:501:ffff:1000::1000]:1357;branch=z9hG4bK74bf9

Route: <sip:p.a1.under.test.com:10001;lr>,<sip:orig@s.a1.under.test.com;lr>

Max-Forwards: 70

From: <sip:UEa1_public_1@under.test.com>;tag=9fxced76sl

To: <sip:UEa2_public_1@under.test.com>;tag=314259

Call-ID: 3848276298220188511@under.test.com

CSeq: 1 ACK

Content-Length: 0

[OBSERVABLE RESULTS]

*1: 4 ACK from NUT to P-CSCF.

See generic_ACK-non2XX

4.7.27 UE-RR-B-27-AKA - Receiving 606 response

[NAME]

UE-RR-B-27-AKA - Receiving 606 response



[TARGET]

IMS User Equipment (NUT)

[PURPOSE]

To verify that the UEa1 properly process a 606 (Not Acceptable) response, and verify that the UEa1 properly creates an ACK request.

[REFERENCE]

TS24.229 A.2.1.4.1

[REQUIREMENT]

NONE

[PARAMETER(NUT)]

public-user-id : sip:UEa1_public_1@under.test.com
private-user-id : UEa1_private@under.test.com
contact_URI : sip:UEa1_public_1@node.under.test.com
HOMENETWORK Domain : sip:under.test.com

[PARAMETER(TESTER)]

public-user-id(UEa2) : sip:UEa2_public_1@under.test.com
P-CSCFa1 : sip:p.a1.under.test.com

[ADDRESS]

UEa1(NUT) : 3ffe:501:ffff:1000::1000
Router(R1) : 3ffe:501:ffff:1000::1
P-CSCFa1 : 3ffe:501:ffff:100::10
I-CSCFa1 : 3ffe:501:ffff:100::20
S-CSCFa1 : 3ffe:501:ffff:100::30
DNS : 3ffe:501:ffff:100::40
DHCP : 3ffe:501:ffff:100::50

UEa2 : 3ffe:501:ffff:2000::1000
P-CSCFa2 : 3ffe:501:ffff:200::10
I-CSCFa2 : 3ffe:501:ffff:200::20



S-CSCFa2 : 3ffe:501:fff:200::30

[TOPOLOGY]

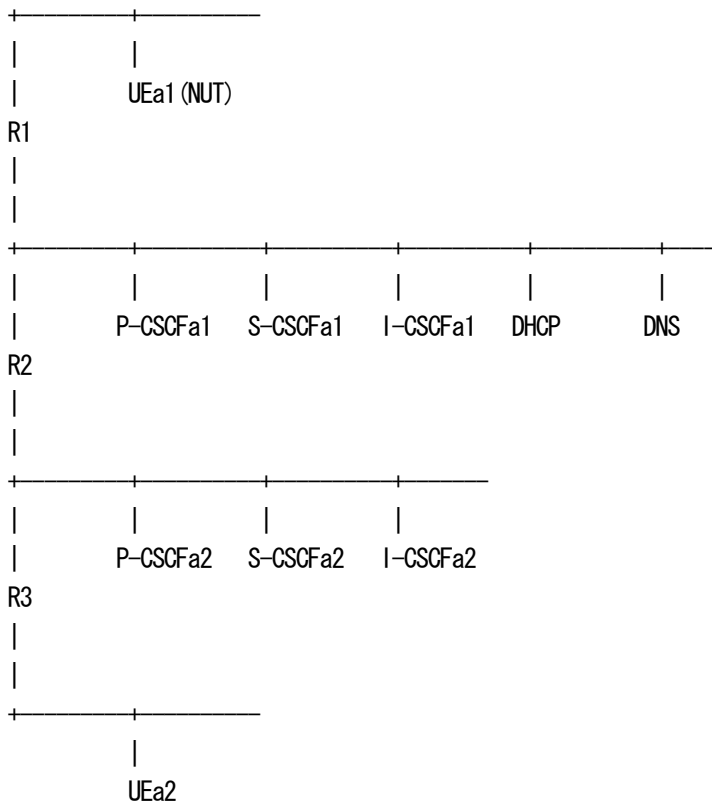

[INITIALIZATION]

UEa1(NUT) must be registered with the tester by executing the scenario "UE-INI-B-1-AKA".
 For details of "UE-INI-B-1-AKA", refer to the profile "UE-RG-B-1-AKA".

[PROCEDURE]

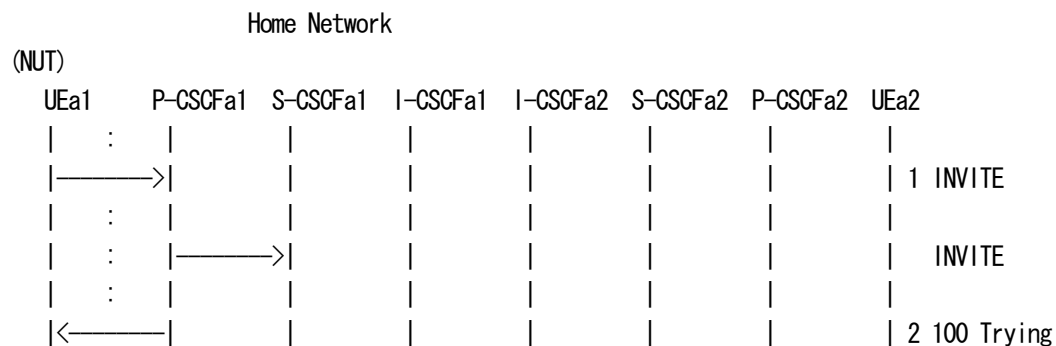

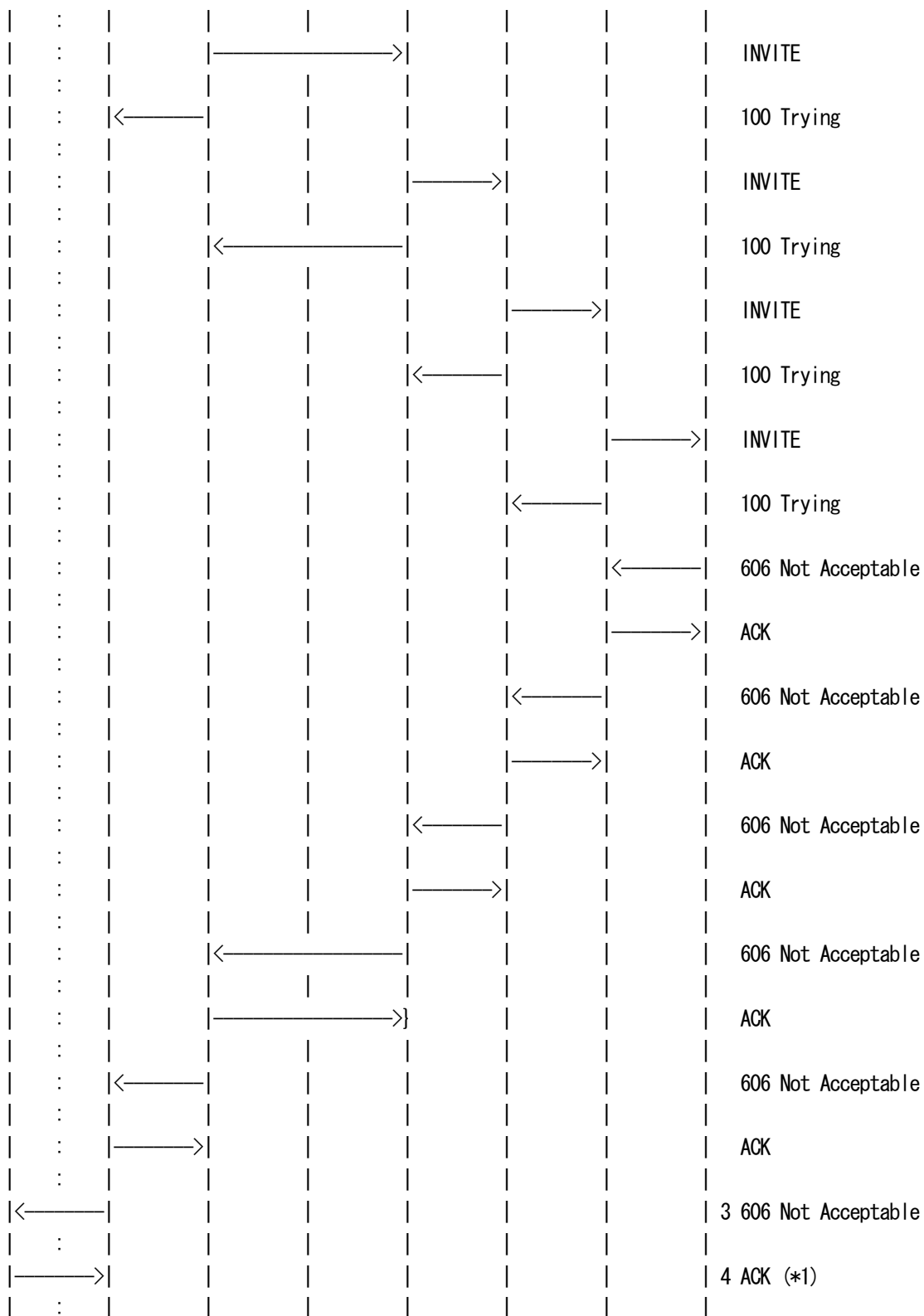

1 NUT sends INVITE



- 2 NUT receives 100 Trying
- 3 NUT receives 606 Not Acceptable
- 4 NUT sends ACK

=== Message example ===

As regards the message 1-2, please refer to the message 1-2 in UE-SE-B-1-AKA.

3. 606 Not Acceptable P-CSCF -> NUT
SIP/2.0 606 Not Acceptable
Via: SIP/2.0/UDP [3ffe:501:ffff:1000::1000]:1357;branch=z9hG4bK74bf9
From: <sip:UEa1_public_1@under.test.com>;tag=9fxced76sl
To: <sip:UEa2_public_1@under.test.com>;tag=314259
Call-ID: 3848276298220188511@under.test.com
CSeq: 1 INVITE
Content-Length: 0

4. ACK NUT -> P-CSCF
ACK sip:UEa2_public_1@under.test.com SIP/2.0
Via: SIP/2.0/UDP [3ffe:501:ffff:1000::1000]:1357;branch=z9hG4bK74bf9
Route: <sip:p.a1.under.test.com:10001;lr>,<sip:orig@s.a1.under.test.com;lr>
Max-Forwards: 70
From: <sip:UEa1_public_1@under.test.com>;tag=9fxced76sl
To: <sip:UEa2_public_1@under.test.com>;tag=314259
Call-ID: 3848276298220188511@under.test.com
CSeq: 1 ACK
Content-Length: 0

[OBSERVABLE RESULTS]

*1: 4 ACK from NUT to P-CSCF.

See generic_ACK-non2XX

4.7.28 UE-RR-B-28-AKA - Reception of 504 response to Session initiation

[NAME]

UE-RR-B-28-AKA - Reception of 504 response to Session initiation



[TARGET]

IMS User Equipment (NUT)

[PURPOSE]

To verify that the UEa1 properly performs the procedures for initial registration after received 504 (Server Time-out) response containing a P-Asserted-Identity header field set to the SIP URI of the Path header field during the registration and a Content-Type header field set to a "application/3gpp-ims+xml" and related IM CM subsystem XML body.

[REFERENCE]

TS24.229 5.1.2A.1.6

TS24.229 A.2.1.4.1

[REQUIREMENT]

NONE

[PARAMETER(NUT)]

public-user-id : sip:UEa1_public_1@under.test.com
private-user-id : UEa1_private@under.test.com
contact_URI : sip:UEa1_public_1@node.under.test.com
HOMENETWORK Domain : sip:under.test.com

[PARAMETER(TESTER)]

public-user-id(UEa2) : sip:UEa2_public_1@under.test.com
P-CSCFa1 : sip:p.a1.under.test.com

[ADDRESS]

UEa1(NUT) : 3ffe:501:fff:1000::1000
Router(R1) : 3ffe:501:fff:1000::1
P-CSCFa1 : 3ffe:501:fff:100::10
I-CSCFa1 : 3ffe:501:fff:100::20
S-CSCFa1 : 3ffe:501:fff:100::30
DNS : 3ffe:501:fff:100::40
DHCP : 3ffe:501:fff:100::50



```

UEa2           :          3ffe:501:ffff:2000::1000
P-CSCFa2      :          3ffe:501:ffff:200::10
I-CSCFa2      :          3ffe:501:ffff:200::20
S-CSCFa2      :          3ffe:501:ffff:200::30
  
```

[TOPOLOGY]

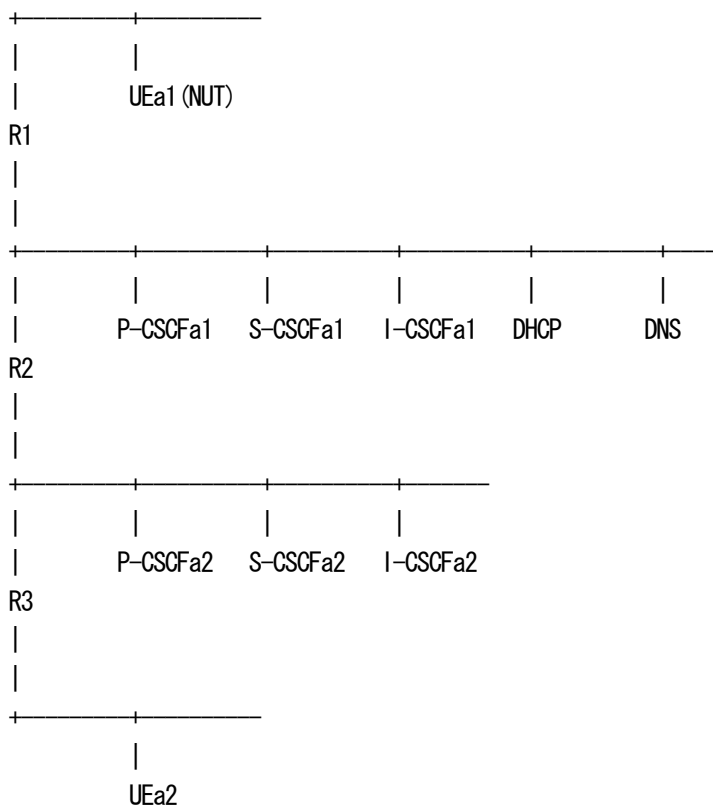

[INITIALIZATION]

UEa1(NUT) must be registered with the tester by executing the scenario "UE-INI-B-1-AKA".
 For details of "UE-INI-B-1-AKA", refer to the profile "UE-RG-B-1-AKA".

[PROCEDURE]

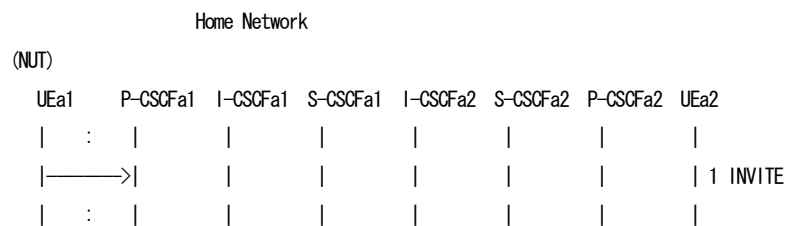



```

| : |----->| | | | | | | | INVITE
| : | | | | | | | | |
|<-----| | | | | | | | | 2 100 Trying
| : | | | | | | | | |
| : |<-----| | | | | | | | | 480 Temporarily Unavailable
| : | | | | | | | | |
| : |----->| | | | | | | | | ACK
| : | | | | | | | | |
|<-----| | | | | | | | | 3 504 Server Time-out
| : | | | | | | | | |
|----->| | | | | | | | | 4 ACK
| : | | | | | | | | |
| : | | | | | | | | |
|----->| | | | 5 REGISTER (*1)
| : | | | | | | | | |
| : |----->| | | | REGISTER
| : | | | | | | | | |
| : | |----->| | | | REGISTER
| : | | | | | | | | |
| : | |<-----| | | | 401 Unauthorized
| : | | | | | | | | |
| : |<-----| | | | 401 Unauthorized
| : | | | | | | | | |
|<-----| | | | 6 401 Unauthorized
| : | | | | | | | | |
|----->| | | | 7 REGISTER for authentication (*2)
| : | | | | | | | | |
| : |----->| | | | REGISTER for authentication
| : | | | | | | | | |
| : | |----->| | | | REGISTER for authentication
| : | | | | | | | | |
| : | |<-----| | | | 200 OK
| : | | | | | | | | |
| : |<-----| | | | 200 OK
| : | | | | | | | | |
|<-----| | | | 8 200 OK
| : | | | | | | | | |
|----->| | | | 9 SUBSCRIBE (*3)
| : | | | | | | | | |
| : |----->| | | | SUBSCRIBE
| : | | | | | | | | |
| : |<-----| | | | 200 OK
| : | | | | | | | | |

```

```

|<-----|      |      | 10 200 OK
| : |      |      |
| : |<-----|      | NOTIFY
| : |      |      |
|<-----|      |      | 11 NOTIFY
| : |      |      |
|----->|      |      | 12 200 OK (*4)
| : |      |      |
| : |----->|      | 200 OK
| : |      |      |

```

- 1 NUT sends INVITE
- 2 NUT receives 100 Trying
- 3 NUT receives 504 Server Time-out
- 4 NUT sends ACK
- 5 NUT sends REGISTER
- 6 NUT receives 401 Unauthorized
- 7 NUT sends REGISTER for authentication
- 8 NUT receives 200 OK
- 9 NUT sends SUBSCRIBE
- 10 NUT receives 200 OK
- 11 NUT receives NOTIFY
- 12 NUT sends 200 OK

=== Message example ===

As regards the message 1-2, please refer to the message 1-2 in UE-SE-B-1-AKA.

3. 504 Server Time-out P-CSCF -> NUT

SIP/2.0 504 Server Time-out

Via: SIP/2.0/UDP [3ffe:501:ffff:1000::1000]:1357;branch=z9hG4bK74bf9

From: <sip:UEa1_public_1@under.test.com>;tag=9fxced76sl

To: <sip:UEa2_public_1@under.test.com>;tag=314259

Call-ID: 3848276298220188511@under.test.com

CSeq: 1 INVITE

P-Asserted-Identity: <sip:term@p.a1.under.test.com>

Content-Type: application/3gpp-ims+xml

Content-Length: (...)

```
<?xml version="1.0" encoding="UTF-8"?>
```

```
<ims-3gpp version="1">
```

```
  <alternative-service>
```

```
    <type>%x72.65.73.74.6F.72.61.74.69.6F.6E</type>
```



<reason>operator configurable reason</reason>
<action>%x69.6E.69.74.69.61.6C.2D.72.65.67.69.73.74.72.61.74.69.6F.6E</action>
</alternative-service>
</ims-3gpp>

4. ACK NUT -> P-CSCF
ACK sip:UEa2_public_1@under.test.com SIP/2.0
Via: SIP/2.0/UDP [3ffe:501:ffff:1000::1000]:1357;branch=z9hG4bK74bf9
Route: <sip:p.a1.under.test.com:10001;lr>, <sip:orig@s.a1.under.test.com;lr>
Max-Forwards: 70
From: <sip:UEa1_public_1@under.test.com>;tag=9fxced76sl
To: <sip:UEa2_public_1@under.test.com>;tag=314259
Call-ID: 3848276298220188511@under.test.com
CSeq: 1 ACK
Content-Length: 0

As regards the message 5-12, please refer to the message 11-18 in UE-RG-B-14-AKA.

[OBSERVABLE RESULTS]

*1: 5 REGISTER from NUT to P-CSCF

See generic_REGISTER

*2: 7 REGISTER for authentication from NUT to P-CSCF

See generic_Auth_REGISTER

*3: 9 SUBSCRIBE from NUT to P-CSCF

See generic_SUBSCRIBE

*4: 12 NOTIFY 200 OK from NUT to P-CSCF

See generic_200-NOTIFY

4.8 SigComp

4.8.1 UE-SC-B-1-AKA - SigComp for IMS (Sends INVITE and receives BYE)



[NAME]

UE-SC-B-1-AKA - SigComp for IMS (Sends INVITE and receives BYE)

[TARGET]

IMS User Equipment (NUT)

[PURPOSE]

To verify that the UEa1 properly uses SigComp to signaling.

(1) To verify that the UEa1 properly compress SIP messages.

(2) To verify that the UEa1 properly decompress compressed messages.

(3) To verify that the UEa1 finished compertment when it is deregistered.

[REFERENCE]

TS24.229 8.1.1

TS24.229 8.1.2

TS24.229 8.1.3

RFC3486 4

RFC3486 5

RFC5049 9.1

RFC5049 9.4

[REQUIREMENT]

NONE

[PARAMETER(NUT)]

public-user-id : sip:UEa1_public_1@under.test.com

private-user-id : UEa1_private@under.test.com

contact_URI : sip:UEa1_public_1@node.under.test.com

HOMENETWORK Domain : sip:under.test.com

[PARAMETER(TESTER)]

public-user-id(UEa2) : sip:UEa2_public_1@under.test.com

P-CSCFa1 : sip:p.a1.under.test.com

S-CSCFa1 : sip:s.a1.under.test.com



[ADDRESS]

UEa1(NUT) : 3ffe:501:fff:1000::1000
Router(R1) : 3ffe:501:fff:1000::1
P-CSCFa1 : 3ffe:501:fff:100::10
I-CSCFa1 : 3ffe:501:fff:100::20
S-CSCFa1 : 3ffe:501:fff:100::30
DNS : 3ffe:501:fff:100::40
DHCP : 3ffe:501:fff:100::50

UEa2 : 3ffe:501:fff:2000::1000
P-CSCFa2 : 3ffe:501:fff:200::10
I-CSCFa2 : 3ffe:501:fff:200::20
S-CSCFa2 : 3ffe:501:fff:200::30

[TOPOLOGY]

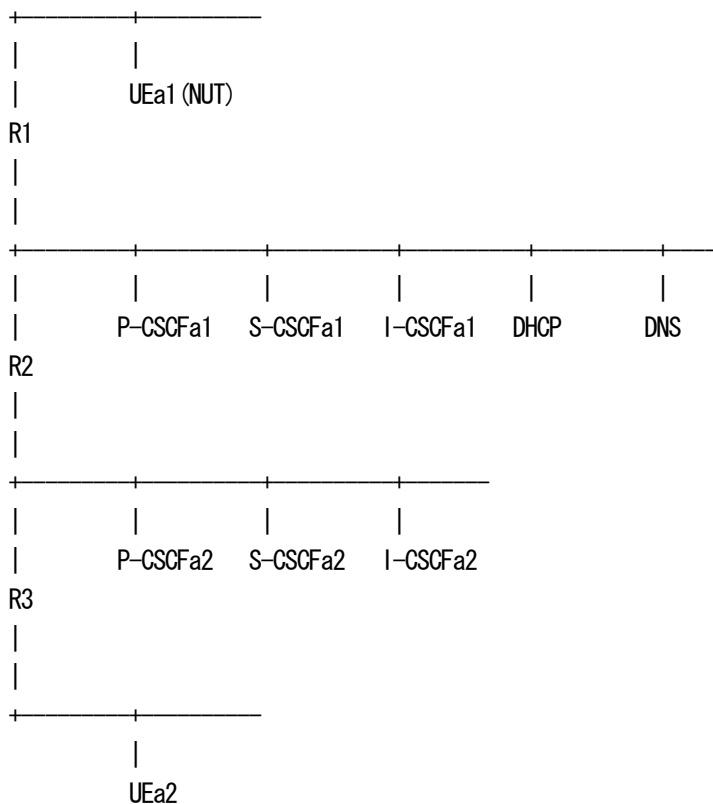

[INITIALIZATION]

Set up IP Address using A or B.



A. Router Advertisement

B. DHCPv6

(NUT)

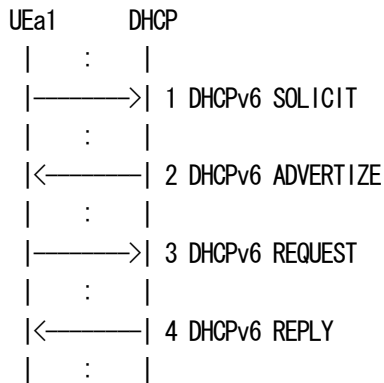

[PROCEDURE]

Home Network

(NUT)

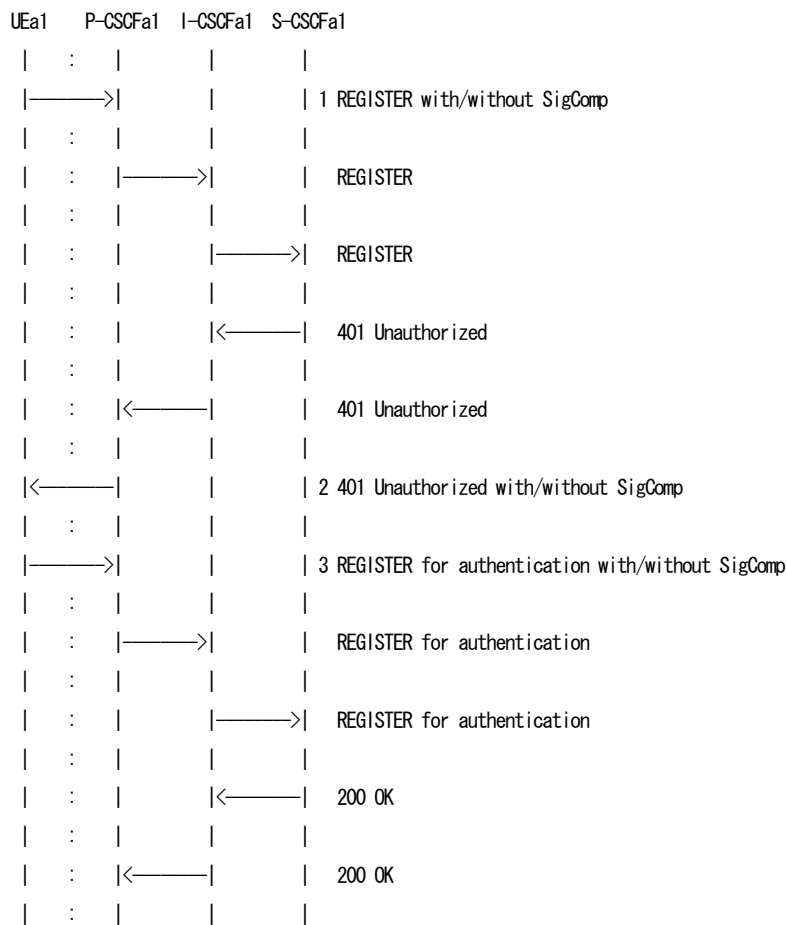



```

|<-----|           |           | 4 200 OK with/without SigComp
| : |           |           |
|----->|           |           | 5 SUBSCRIBE with SigComp (*1)
| : |           |           |
| : |----->|           | SUBSCRIBE
| : |           |           |
| : |<-----|           | 200 OK
| : |           |           |
|<-----|           |           | 6 200 OK with SigComp
| : |           |           |
| : |<-----|           | NOTIFY
| : |           |           |
|<-----|           |           | 7 NOTIFY with SigComp
| : |           |           |
|----->|           |           | 8 200 OK with SigComp (*2)
| : |           |           |
| : |----->|           | 200 OK
| : |           |           |
| : |           |           |           I-CSCFa2 S-CSCFa2 P-CSCFa2 UEa2
| : |           |           |           |           |           |           |
|----->|           |           |           |           |           |           | 9 INVITE with SigComp (*3)
| : |           |           |           |           |           |           |
| : |----->|           |           |           |           |           |           | INVITE
| : |           |           |           |           |           |           |
|<-----|           |           |           |           |           |           | 10 100 Trying with SigComp
| : |           |           |           |           |           |           |
| : |           |           |           |----->|           |           | INVITE
| : |           |           |           |           |           |           |
| : |<-----|           |           |           |           |           |           | 100 Trying
| : |           |           |           |           |           |           |
| : |           |           |           |           |----->|           | INVITE
| : |           |           |           |           |           |           |
| : |           |           |<-----|           |           |           | 100 Trying
| : |           |           |           |           |           |           |
| : |           |           |           |           |           |----->|           | INVITE
| : |           |           |           |           |           |           |
| : |           |           |           |<-----|           |           |           | 100 Trying
| : |           |           |           |           |           |           |
| : |           |           |           |           |           |           |----->|           | INVITE
| : |           |           |           |           |           |           |
| : |           |           |           |           |<-----|           |           |           | 100 Trying
| : |           |           |           |           |           |           |
| : |           |           |           |           |           |<-----|           | 180 Ringing

```

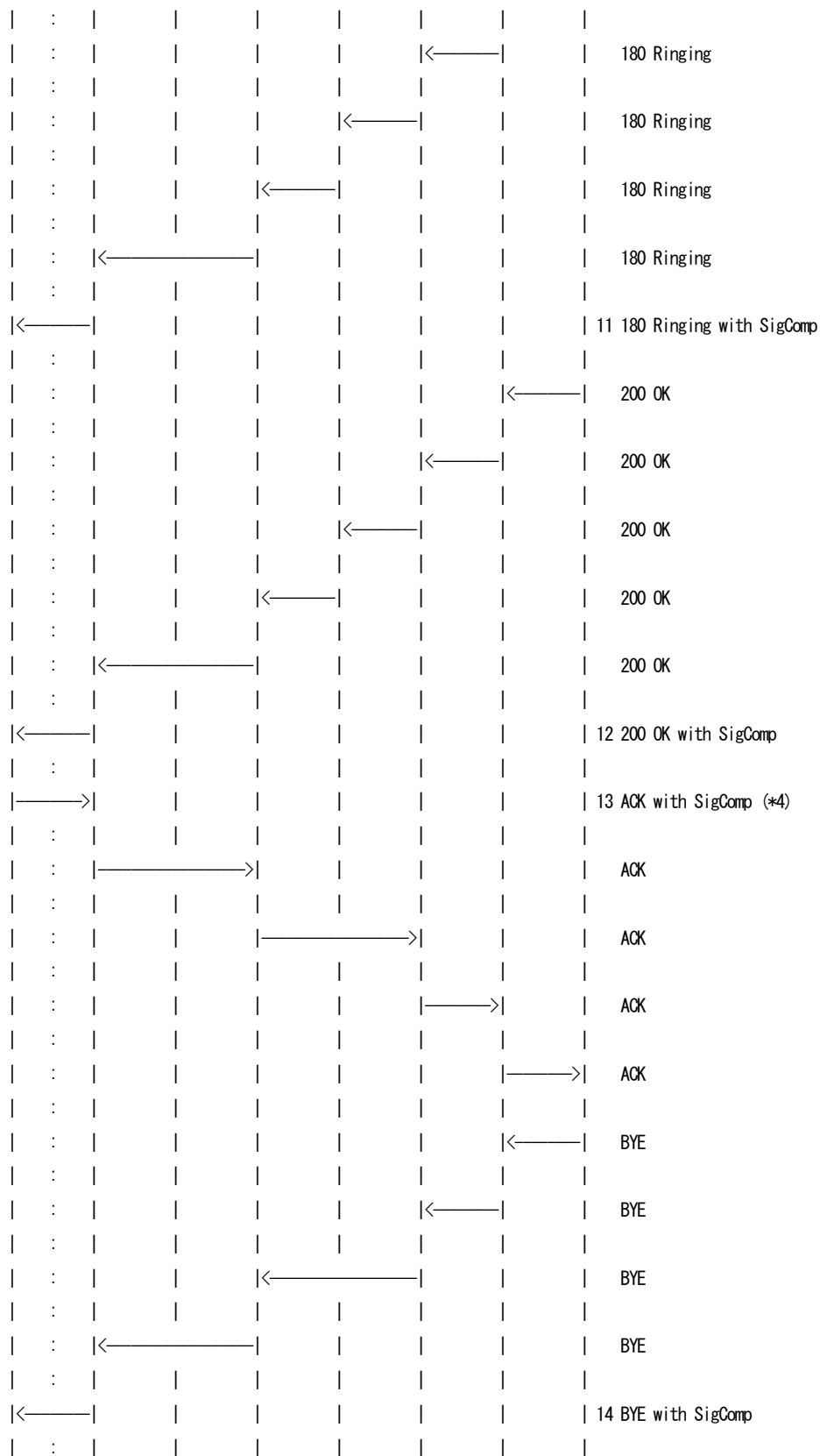

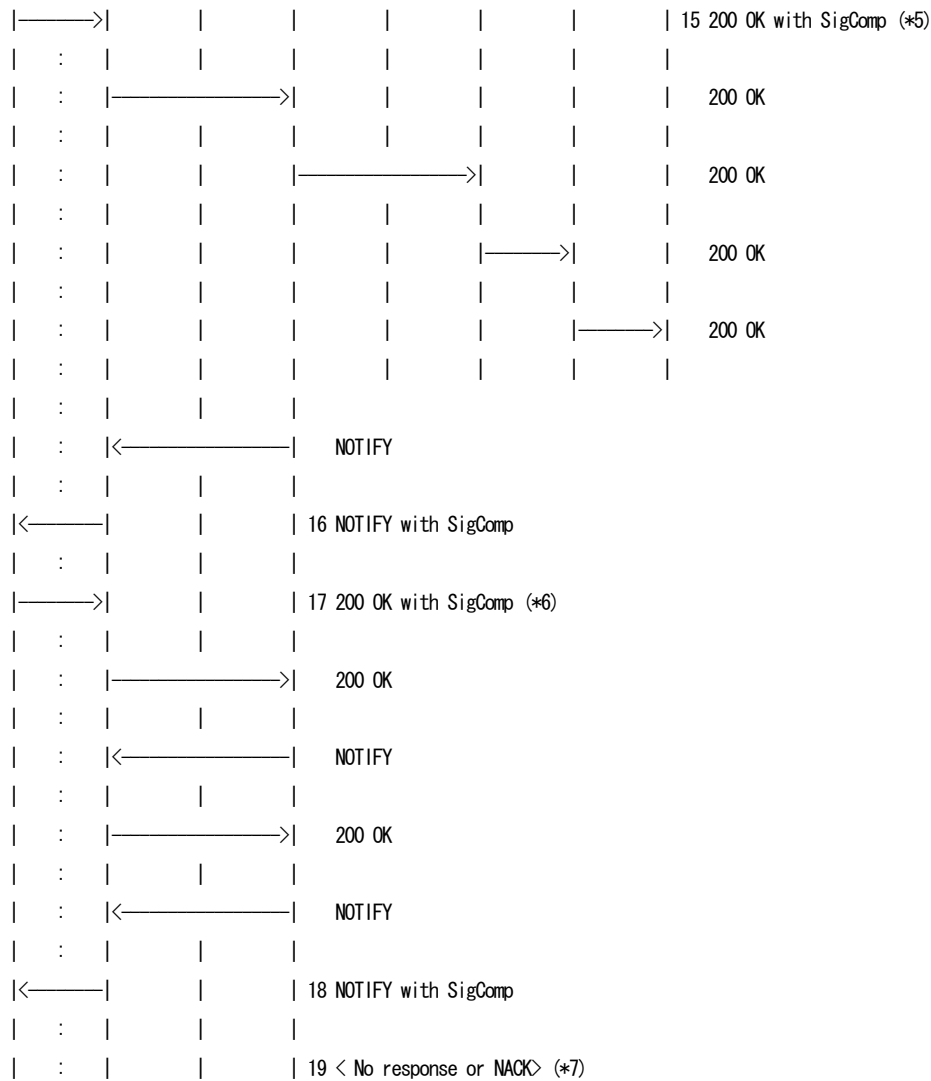

- 1 NUT sends REGISTER with/without SigComp
- 2 NUT receives 401 Unauthorized with/without SigComp
- 3 NUT sends REGISTER for authentication with/without SigComp
- 4 NUT receives 200 OK with/without SigComp
- 5 NUT sends SUBSCRIBE with SigComp
- 6 NUT receives 200 OK with SigComp
- 7 NUT receives NOTIFY with SigComp
- 8 NUT sends 200 OK with SigComp
- 9 NUT sends INVITE with SigComp
- 10 NUT receives 100 Trying with SigComp
- 11 NUT receives 180 Ringing with SigComp
- 12 NUT receives 200 OK with SigComp
- 13 NUT sends ACK with SigComp
- 14 NUT receives BYE with SigComp



15 NUT sends 200 OK with SigComp
16 NUT receives NOTIFY with SigComp
17 NUT sends 200 OK with SigComp
18 NUT receives NOTIFY with SigComp
19 < NUT sends no response or NACK >

=== Message example ===

1. REGISTER NUT -> P-CSCF

```
REGISTER sip:under.test.com SIP/2.0
Via: SIP/2.0/UDP [3ffe:501:ffff:1000::1000]:5060;branch=z9hG4bKnashds7
Max-Forwards : 70
From : <sip:UEa1_public_1@under.test.com>;tag=4fa3
To : <sip:UEa1_public_1@under.test.com>
Contact : <sip:UEa1_public_1@node.under.test.com;comp=sigcomp;
sigcomp-id=urn:uuid:00ffde92-0916-1952-2008fa82a473>;expires=600000
Call-ID : apb03a0s09dkjdfglkj49111@under.test.com
Authorization: Digest username="UEa1_private@under.test.com", realm="under.test.com", nonce="",
uri="sip:under.test.com", response=""
Security-Client: ipsec-3gpp; mode="trans"; alg=hmac-sha-1-96; spi-c=23456789; spi-s=12345678;
port-c=2468; port-s=1357
Require: sec-agree
Proxy-Require: sec-agree
CSeq: 1 REGISTER
Supported: path
Content-Length : 0
```

2. 401 Unauthorized P-CSCF -> NUT

```
SIP/2.0 401 Unauthorized
Via: SIP/2.0/UDP [3ffe:501:ffff:1000::1000]:5060;branch=z9hG4bKnashds7
From : <sip:UEa1_public_1@under.test.com>;tag=4fa3
To : <sip:UEa1_public_1@under.test.com>;tag=5ef4
Call-ID : apb03a0s09dkjdfglkj49111@under.test.com
WWW-Authenticate: Digest realm="under.test.com",
nonce="11U8vpY3qJhiuZNRke/NaponGSCcLm5iR+WCRkWYoM", algorithm=AKAv1-MD5
Security-Server: ipsec-3gpp; alg=hmac-sha-1-96; spi-c=256; spi-s=257; port-c=10002; port-s=10001
CSeq: 1 REGISTER
Content-Length: 0
```



3. REGISTER NUT -> P-CSCF

REGISTER sip:under.test.com SIP/2.0

Via: SIP/2.0/UDP [3ffe:501:ffff:1000::1000]:1357;branch=z9hG4bKnashds8;comp=sigcomp;
sigcomp-id="urn:uuid:00ffde92-0916-1952-2008fa82a473"

Max-Forwards: 70

From: <sip:UEa1_public_1@under.test.com>;tag=4fa4

To: <sip:UEa1_public_1@under.test.com>

Contact: <sip:UEa1_public_1@node.under.test.com:1357;comp=sigcomp;sigcomp-id=urn:
uuid:00ffde92-0916-1952-2008fa82a473>;expires=600000

Call-ID: apb03a0s09dkjdfglkj49111@under.test.com

Authorization: Digest username="UEa1_private@under.test.com", realm="under.test.com",
algorithm=AKAv1-MD5, nonce="l1U8vpY3qJhiuZnrke/NaponGSCcLm5iR+WCRkWYoM",
uri="sip:under.test.com", response="6629fae49393a05397450978507c4ef1"

Security-Client: ipsec-3gpp; mode="trans"; alg=hmac-sha-1-96; spi-c=23456789; spi-s=12345678;
port-c=2468; port-s=1357

Security-Verify: ipsec-3gpp; alg=hmac-sha-1-96; spi-c=256; spi-s=257; port-c=10002; port-s=10001

Require: sec-agree

Proxy-Require: sec-agree

CSeq: 2 REGISTER

Supported: path

Content-Length: 0

4. 200 OK P-CSCF -> NUT

SIP/2.0 200 OK

Via: SIP/2.0/UDP [3ffe:501:ffff:1000::1000]:1357;branch=z9hG4bKnashds8;comp=sigcomp;
sigcomp-id="urn:uuid:00ffde92-0916-1952-2008fa82a473"

Path: <sip:term@p.a1.under.test.com;lr>

Service-Route: <sip:orig@s.a1.under.test.com;lr>

From: <sip:UEa1_public_1@under.test.com>;tag=4fa4

To: <sip:UEa1_public_1@under.test.com>;tag=5ef5

Call-ID: apb03a0s09dkjdfglkj49111@under.test.com

Contact: <sip:UEa1_public_1@node.under.test.com:1357;comp=sigcomp;sigcomp-id=urn:
uuid:00ffde92-0916-1952-2008fa82a473>;expires=600000

CSeq: 2 REGISTER

P-Associated-URI: <sip:UEa1_public_1@under.test.com>

Date: Wed, 11 July 2001 08:49:37 GMT

Content-Length: 0

5. SUBSCRIBE NUT -> P-CSCF

SUBSCRIBE sip:UEa1_public_1@under.test.com SIP/2.0

Via: SIP/2.0/UDP [3ffe:501:ffff:1000::1000]:1357;branch=z9hG4bKnashds7;comp=sigcomp;



sigcomp-id="urn:uuid:00ffde92-0916-1952-2008fa82a473"
Max-Forwards: 70
Route: <sip:p.a1.under.test.com:10001;lr>,<sip:orig@s.a1.under.test.com;lr>
P-Access-Network-Info: 3GPP-UTRAN-TDD;utran-cell-id-3gpp=123456A1BDS23
From: <sip:UEa1_public_1@under.test.com>;tag=31415
To: <sip:UEa1_public_1@under.test.com>
Require: sec-agree
Proxy-Require: sec-agree
Call-ID: b89rjhnedlrfflsj40a222@under.test.com
CSeq: 61 SUBSCRIBE
Allow-Events: reg
Event: reg
Security-Verify: ipsec-3gpp; alg=hmac-sha-1-96; spi-c=256; spi-s=257; port-c=10002; port-s=10001
Expires: 600000
Contact: <sip:UEa1_public_1@node.under.test.com:1357;comp=sigcomp;
sigcomp-id=urn:uuid:00ffde92-0916-1952-2008fa82a473>
Content-Length: 0

6. 200 OK P-CSCF -> NUT

SIP/2.0 200 OK

Via: SIP/2.0/UDP [3ffe:501:ffff:1000::1000]:1357;branch=z9hG4bKnashds7;comp=sigcomp;
sigcomp-id="urn:uuid:00ffde92-0916-1952-2008fa82a473"
Record-Route: <sip:p.a1.under.test.com:10001;lr;comp=sigcomp;
sigcomp-id=urn:uuid:11edab92-0916-1952-2008ec24b5678>
From: <sip:UEa1_public_1@under.test.com>;tag=31415
To: <sip:UEa1_public_1@under.test.com>;tag=151170
Call-ID: b89rjhnedlrfflsj40a222@under.test.com
CSeq: 61 SUBSCRIBE
Allow-Events: reg
Expires: 600000
Contact: <sip:s.a1.under.test.com>
Content-Length: 0

7. NOTIFY P-CSCF -> NUT

NOTIFY sip:UEa1_public_1@node.under.test.com:1357;comp=sigcomp;
sigcomp-id=urn:uuid:00ffde92-0916-1952-2008fa82a473 SIP/2.0
Via: SIP/2.0/UDP p.a1.under.test.com:10001;branch=z9hG4bK240f34.1;comp=sigcomp;
sigcomp-id="urn:uuid:11edab92-0916-1952-2008ec24b5678",SIP/2.0/UDP s.a1.under.test.com;
branch=z9hG4bK332b23.1;received=3ffe:501:ffff:100::30
Max-Forwards: 69
From: <sip:UEa1_public_1@under.test.com>;tag=151170



To: <sip:UEa1_public_1@under.test.com>;tag=31415
Call-ID: b89rjhnedlrffjlsj40a222@under.test.com
CSeq: 62 NOTIFY
Subscription-State: active;expires=600000
Event: reg
Content-Type: application/reginfo+xml
Contact: <sip:s.a1.under.test.com>
Content-Length: (...)

```
<?xml version="1.0"?>
<reginfo xmlns="urn:ietf:params:xml:ns:reginfo" version="0" state="full">
  <registration aor="sip:UEa1_public_1@under.test.com" id="a7" state="active">
    <contact id="76" state="active" event="registered">
      <uri>sip:UEa1_public_1@node.under.test.com</uri>
    </contact>
  </registration>
</reginfo>
```

8. 200 OK NUT -> P-CSCF

SIP/2.0 200 OK

Via: SIP/2.0/UDP p.a1.under.test.com:10001;branch=z9hG4bK240f34.1;comp=sigcomp;
sigcomp-id="um:uuid:11edab92-0916-1952-2008ec24b5678";received=3ffe:501:ffff:100::10,
SIP/2.0/UDP s.a1.under.test.com;branch=z9hG4bK332b23.1;received=3ffe:501:ffff:100::30
From: <sip:UEa1_public_1@under.test.com>;tag=151170
To: <sip:UEa1_public_1@under.test.com>;tag=31415
Call-ID: b89rjhnedlrffjlsj40a222@under.test.com
CSeq: 62 NOTIFY
P-Access-Network-Info: 3GPP-UTRAN-TDD;utran-cell-id-3gpp=123456A1BDS23
Content-Length: 0

9. INVITE NUT -> P-CSCF

INVITE sip:UEa2_public_1@under.test.com SIP/2.0

Via: SIP/2.0/UDP [3ffe:501:ffff:1000::1000]:1357;branch=z9hG4bK74bf9;comp=sigcomp;
sigcomp-id="um:uuid:00ffde92-0916-1952-2008fa82a473"
Route: <sip:p.a1.under.test.com:10001;lr>,<sip:orig@s.a1.under.test.com;lr>
Max-Forwards: 70
From: <sip:UEa1_public_1@under.test.com>;tag=9fxced76sl
To: <sip:UEa2_public_1@under.test.com>
Call-ID: 3848276298220188511@under.test.com
CSeq: 1 INVITE
Contact: <sip:UEa1_public_1@node.under.test.com:1357;comp=sigcomp;



sigcomp-id=urn:uuid:00ffde92-0916-1952-2008fa82a473>
Supported:
Allow: INVITE,ACK,CANCEL,OPTIONS,BYE
Allow-Events: reg
Accept: application/sdp,application/3gpp-ims+xml
Require: sec-agree
Proxy-Require: sec-agree
Security-Verify: ipsec-3gpp; alg=hmac-sha-1-96; spi-c=256; spi-s=257; port-c=10002; port-s=10001
P-Access-Network-Info: 3GPP-UTRAN-TDD;utran-cell-id-3gpp=123456A1BDS23
Content-Type: application/sdp
Content-Length: 154

v=0
o=UEa1 2890844526 2890844526 IN IP6 node.under.test.com
s=
c=IN IP6 node.under.test.com
t=0 0
m=audio 49172 RTP/AVP 0
b=AS:75
a=rtpmap:0 PCMU/8000

10. 100 Trying P-CSCF -> NUT

SIP/2.0 100 Trying
Via: SIP/2.0/UDP [3ffe:501:ffff:1000::1000]:1357;branch=z9hG4bK74bf9;comp=sigcomp;
sigcomp-id="urn:uuid:00ffde92-0916-1952-2008fa82a473"
From: <sip:UEa1_public_1@under.test.com>;tag=9fxced76sl
To: <sip:UEa2_public_1@under.test.com>
Call-ID: 3848276298220188511@under.test.com
CSeq: 1 INVITE
Content-Length: 0

11. 180 Ringing P-CSCF -> NUT

SIP/2.0 180 Ringing
Via: SIP/2.0/UDP [3ffe:501:ffff:1000::1000]:1357;branch=z9hG4bK74bf99;comp=sigcomp;
sigcomp-id="urn:uuid:00ffde92-0916-1952-2008fa82a473"
From: <sip:UEa1_public_1@under.test.com>;tag=9fxced76sl
To: <sip:UEa2_public_1@under.test.com>;tag=314159
Call-ID: 3848276298220188511@under.test.com
CSeq: 1 INVITE
Content-Length: 0



12. 200 OK P-CSCF -> NUT

SIP/2.0 200 OK

Via: SIP/2.0/UDP [3ffe:501:ffff:1000::1000]:1357;branch=z9hG4bK74bf99;comp=sigcomp;

sigcomp-id="um:uuid:00ffde92-0916-1952-2008fa82a473"

Record-Route: <sip:p.a2.under.test.com;lr>,<sip:s.a2.under.test.com;lr>,<sip:s.a1.under.test.com;lr>,<sip:p.a1.under.test.com:10001;lr;comp=sigcomp ;

sigcomp-id=um:uuid:11edab92-0916-1952-2008ec24b5678>

From: <sip:UEa1_public_1@under.test.com>;tag=9fxced76sl

To: <sip:UEa2_public_1@under.test.com>;tag=314159

Call-ID: 3848276298220188511@under.test.com

CSeq: 1 INVITE

Contact: <sip:UEa2_public_1@nodea2.under.test.com:22222>

Supported:

Allow: INVITE,ACK,CANCEL,OPTIONS,BYE

Allow-Events: reg

Content-Type: application/sdp

Content-Length: 153

v=0

o=UEa2 2890844527 2890844527 IN IP6 nodea2.under.test.com

s=-

c=IN IP6 nodea2.under.test.com

t=0 0

m=audio 3456 RTP/AVP 0

b=AS:75

a=rtpmap:0 PCMU/8000

13. ACK NUT -> P-CSCF

ACK sip:UEa2_public_1@nodea2.under.test.com:22222 SIP/2.0

Via: SIP/2.0/UDP [3ffe:501:ffff:1000::1000]:1357;branch=z9hG4bK74b769;comp=sigcomp;

sigcomp-id="um:uuid:00ffde92-0916-1952-2008fa82a473"

Route: <sip:p.a1.under.test.com:10001;lr;comp=sigcomp;

sigcomp-id=um:uuid:11edab92-0916-1952-2008ec24b5678>,<sip:s.a1.under.test.com;lr>,<sip:s.a2.under.test.com;lr>,<sip:p.a2.under.test.com;lr>

Max-Forwards: 70

From: <sip:UEa1_public_1@under.test.com>;tag=9fxced76sl

To: <sip:UEa2_public_1@under.test.com>;tag=314159

Call-ID: 3848276298220188511@under.test.com

CSeq: 1 ACK

Content-Length: 0



14. BYE P-CSCF -> NUT

BYE sip:UEa1_public_1@node.under.test.com:1357;comp=sigcomp;
sigcomp-id=urn:uuid:00ffde92-0916-1952-2008fa82a473 SIP/2.0
Via: SIP/2.0/UDP p.a1.under.test.com:10001;branch=z9hG4bK431e418c4.2;
comp=sigcomp;sigcomp-id="urn:uuid:11edab92-0916-1952-2008ec24b5678",
SIP/2.0/UDP s.a1.under.test.com;branch=z9hG4bKnashds7;received=3ffe:501:ffff:100::30,
SIP/2.0/UDP s.a2.under.test.com;branch=z9hG4bK721e418c4.1;received=3ffe:501:ffff:200::30,
SIP/2.0/UDP p.a2.under.test.com;branch=z9hG4bKnaghds8;received=3ffe:501:ffff:200::10,
SIP/2.0/UDP [3ffe:501:ffff:2000::1000]:22222;branch=z9hG4bKnashds7
Max-Forwards: 66
From: <sip:UEa2_public_1@under.test.com>;tag=314159
To: <sip:UEa1_public_1@under.test.com>;tag=9fxced76sl
Call-ID: 3848276298220188511@under.test.com
CSeq: 2 BYE
Content-Length: 0

15. 200 OK NUT -> P-CSCF

SIP/2.0 200 OK
Via: SIP/2.0/UDP p.a1.under.test.com:10001;branch=z9hG4bK431e418c4.2;comp=sigcomp;
sigcomp-id="urn:uuid:11edab92-0916-1952-2008ec24b5678";received=3ffe:501:ffff:100::10,
SIP/2.0/UDP s.a1.under.test.com;branch=z9hG4bKnashds7;received=3ffe:501:ffff:100::30,
SIP/2.0/UDP s.a2.under.test.com;branch=z9hG4bK721e418c4.1;received=3ffe:501:ffff:200::30,
SIP/2.0/UDP p.a2.under.test.com;branch=z9hG4bKnaghds8;received=3ffe:501:ffff:200::10,
SIP/2.0/UDP [3ffe:501:ffff:2000::1000]:22222;branch=z9hG4bKnashds7
From: <sip:UEa2_public_1@under.test.com>;tag=314159
To: <sip:UEa1_public_1@under.test.com>;tag=9fxced76sl
Call-ID: 3848276298220188511@under.test.com
CSeq: 2 BYE
P-Access-Network-Info: 3GPP-UTRAN-TDD;utran-cell-id-3gpp=123456A1BDS23
Content-Length: 0

16. NOTIFY P-CSCF -> NUT

NOTIFY sip:UEa1_public_1@node.under.test.com:1357;comp=sigcomp;
sigcomp-id=urn:uuid:00ffde92-0916-1952-2008fa82a473 SIP/2.0
Via: SIP/2.0/UDP p.a1.under.test.com:10001;branch=z9hG4bK240f34.1;
comp=sigcomp;sigcomp-id="urn:uuid:11edab92-0916-1952-2008ec24b5678",
SIP/2.0/UDP s.a1.under.test.com;branch=z9hG4bK332b23.1;received=3ffe:501:ffff:100::30
Max-Forwards: 69
From: <sip:UEa1_public_1@under.test.com>;tag=151170
To: <sip:UEa1_public_1@under.test.com>;tag=31415



Call-ID: b89rjhnedlrffflslj40a222@under.test.com
CSeq: 43 NOTIFY
Subscription-State: terminated
Event: reg
Content-Type: application/reginfo+xml
Contact: <sip:s.a1.under.test.com>
Content-Length: (...)

```
<?xml version="1.0"?>
<reginfo xmlns="urn:ietf:params:xml:ns:reginfo" version="1" state="full">
  <registration aor="sip:UEa1_public_1@under.test.com" id="as9" state="terminated">
    <contact id="76" state="terminated" event="rejected">
      <uri>sip:UEa1_public_1@node.under.test.com</uri>
    </contact>
  </registration>
</reginfo>
```

17. 200 OK NUT -> P-CSCF

SIP/2.0 200 OK

Via: SIP/2.0/UDP p.a1.under.test.com:10001;branch=z9hG4bK240f34.1;comp=sigcomp;
sigcomp-id="urn:uuid:11edab92-0916-1952-2008ec24b5678";received=3ffe:501:ffff:100::10,
SIP/2.0/UDP s.a1.under.test.com;branch=z9hG4bK332b23.1;received=3ffe:501:ffff:100::30
From: <sip:UEa1_public_1@under.test.com>;tag=151170
To: <sip:UEa1_public_1@under.test.com>;tag=31415
Call-ID: b89rjhnedlrffflslj40a222@under.test.com
CSeq: 43 NOTIFY
P-Access-Network-Info: 3GPP-UTRAN-TDD;utran-cell-id-3gpp=123456A1BDS23
Content-Length: 0

18. NOTIFY P-CSCF -> NUT

NOTIFY sip:UEa1_public_1@node.under.test.com:1357;comp=sigcomp;
sigcomp-id=urn:uuid:00ffde92-0916-1952-2008fa82a473 SIP/2.0
Via: SIP/2.0/UDP p.a1.under.test.com:10001;branch=z9hG4bK240f34.1;
comp=sigcomp;sigcomp-id="urn:uuid:11edab92-0916-1952-2008ec24b5678",
SIP/2.0/UDP s.a1.under.test.com;branch=z9hG4bK332b23.1;received=3ffe:501:ffff:100::30
Max-Forwards: 69
From: <sip:UEa1_public_1@under.test.com>;tag=151170
To: <sip:UEa1_public_1@under.test.com>;tag=31415
Call-ID: b89rjhnedlrffflslj40a222@under.test.com
CSeq: 44 NOTIFY
Subscription-State: terminated



Event: reg
Content-Type: application/reginfo+xml
Contact: <sip:s.a1.under.test.com>
Content-Length: (...)

```
<?xml version="1.0"?>
<reginfo xmlns="urn:ietf:params:xml:ns:reginfo" version="2" state="full">
  <registration aor="sip:UEa1_public_1@under.test.com" id="as9" state="terminated">
    <contact id="76" state="terminated" event="rejected">
      <uri>sip:UEa1_public_1@node.under.test.com</uri>
    </contact>
  </registration>
</reginfo>
```

[OBSERVABLE RESULTS]

*1: 5 SUBSCRIBE from NUT to P-CSCF

See generic_SUBSCRIBE

- Header Field:

* Contact

If UE would like to receive subsequent requests within the same dialog in the UAS->UAC direction compressed, UE SHOULD add the parameter comp=sigcomp to the URI in the Contact header field.
[RFC3486-4-4]

If UE sends a compressed request, UE SHOULD add the parameter comp=sigcomp to the URI in the Contact header field[RFC3486-4-6]

A SIP/SigComp application placing its URI with the 'comp=sigcomp' parameter in a header field MUST add a 'sigcomp-id' parameter with its SIP/SigComp identifier to that URI.[RFC5049-9.1-9]

The SIP URI 'sigcomp-id' parameter MUST contain a URN [RFC2141].
[RFC5049-9.1-7]

URN MUST be persistent as long as the application stores compartment state related to other SIP/SigComp applications.[RFC5049-9.1-2]

* P-Access-Network-Info



UE SHALL insert a P-Access-Network-Info header into any request for a dialog, any subsequent request (except ACK requests and CANCEL requests) or response (except CANCEL responses) within a dialog or any request for a standalone method.[TS24229-5.1-396]

* Via

If UE sends a compressed request, UE SHOULD add the parameter comp=sigcomp to the topmost entry of the Via header field.
[RFC3486-4-8]

A SIP/SigComp application generating its own Via entry containing the 'comp=sigcomp' parameter MUST add a 'sigcomp-id' parameter with its SIP/SigComp identifier to that Via entry.[RFC5049-9.1-10]

The Via 'sigcomp-id' parameter MUST contain a URN [RFC2141].
[RFC5049-9.1-8]

URN MUST be persistent as long as the application stores compartment state related to other SIP/SigComp applications.[RFC5049-9.1-2]

- Sigcomp behavior:

UE SHOULD compress the requests and responses if UE generates these containing a P-Access-Network-Info header with a value of "3GPP-GERAN", "3GPP-UTRAN-FDD", "3GPP-UTRAN-TDD", "3GPP-E-UTRAN-FDD", "3GPP-E-UTRAN-TDD", "3GPP2-1X", "3GPP2-1X-HRPD", "3GPP2-UMB", "IEEE-802.11", "IEEE-802.11a", "IEEE-802.11b" or "IEEE-802.11g", or "IEEE-802.11n".[TS24229-8.1-11]

*2: 8 200 OK to NOTIFY from NUT to P-CSCF

See generic_200-NOTIFY

- Header Field:

* P-Access-Network-Info

UE SHALL insert a P-Access-Network-Info header into any request for a dialog, any subsequent request (except ACK requests and CANCEL requests) or response (except CANCEL responses) within a dialog or any request for a standalone method.[TS24229-5.1-396]

UE SHALL insert a P-Access-Network-Info header into any response to a request for a dialog, any subsequent request (except CANCEL requests) or response (except CANCEL responses) within a dialog or



any response to a standalone method.[TS24229-5.1-447]

- Sigcomp behavior:

UE SHOULD compress the requests and responses if UE generates these containing a P-Access-Network-Info header with a value of "3GPP-GERAN", "3GPP-UTRAN-FDD", "3GPP-UTRAN-TDD", "3GPP-E-UTRAN-FDD", "3GPP-E-UTRAN-TDD", "3GPP2-1X", "3GPP2-1X-HRPD", "3GPP2-UMB", "IEEE-802.11", "IEEE-802.11a", "IEEE-802.11b" or IEEE-802.11g", or "IEEE-802.11n".[TS24229-8.1-11]

If the topmost Via header field contains the parameter comp=sigcomp, the response SHOULD be compressed.[RFC3486-5-1]

*3: 9 INVITE from NUT to P-CSCF

See generic_INVITE

- Header Field:

* Contact

If UE would like to receive subsequent requests within the same dialog in the UAS->UAC direction compressed, UE SHOULD add the parameter comp=sigcomp to the URI in the Contact header field. [RFC3486-4-4]

If UE sends a compressed request, UE SHOULD add the parameter comp=sigcomp to the URI in the Contact header field[RFC3486-4-6]

A SIP/SigComp application placing its URI with the 'comp=sigcomp' parameter in a header field MUST add a 'sigcomp-id' parameter with its SIP/SigComp identifier to that URI.[RFC5049-9.1-9]

The SIP URI 'sigcomp-id' parameter MUST contain a URN [RFC2141]. [RFC5049-9.1-7]

URN MUST be persistent as long as the application stores compartment state related to other SIP/SigComp applications.[RFC5049-9.1-2]

* P-Access-Network-Info

UE SHALL insert a P-Access-Network-Info header into any request for a dialog, any subsequent request (except ACK requests and CANCEL requests) or response (except CANCEL responses) within a dialog or any request for a standalone method[TS24229-5.1-396]



* Via

If UE sends a compressed request, UE SHOULD add the parameter comp=sigcomp to the topmost entry of the Via header field.
[RFC3486-4-8]

A SIP/SigComp application generating its own Via entry containing the 'comp=sigcomp' parameter MUST add a 'sigcomp-id' parameter with its SIP/SigComp identifier to that Via entry.[RFC5049-9.1-10]

The Via 'sigcomp-id' parameter MUST contain a URN [RFC2141].
[RFC5049-9.1-8]

URN MUST be persistent as long as the application stores compartment state related to other SIP/SigComp applications.[RFC5049-9.1-2]

- Sigcomp behavior:

UE SHOULD compress the requests and responses if UE generates these containing a P-Access-Network-Info header with a value of "3GPP-GERAN", "3GPP-UTRAN-FDD", "3GPP-UTRAN-TDD", "3GPP-E-UTRAN-FDD", "3GPP-E-UTRAN-TDD", "3GPP2-1X", "3GPP2-1X-HRPD", "3GPP2-UMB", "IEEE-802.11", "IEEE-802.11a", "IEEE-802.11b" or IEEE-802.11g", or "IEEE-802.11n".[TS24229-8.1-11]

*4: 13 ACK from NUT to P-CSCF

See generic_ACK

- Header Field:

* Via

If UE sends a compressed request, UE SHOULD add the parameter comp=sigcomp to the topmost entry of the Via header field.
[RFC3486-4-8]

A SIP/SigComp application generating its own Via entry containing the 'comp=sigcomp' parameter MUST add a 'sigcomp-id' parameter with its SIP/SigComp identifier to that Via entry.[RFC5049-9.1-10]

The Via 'sigcomp-id' parameter MUST contain a URN [RFC2141].
[RFC5049-9.1-8]

URN MUST be persistent as long as the application stores compartment state related to other SIP/SigComp applications.[RFC5049-9.1-2]



- Sigcomp behavior:

If the next-hop URI contains the parameter comp=sigcomp, the UE SHOULD compress the request using SigComp.[RFC3486-4-1][RFC5049-9.4-1]

*5: 15 200 OK to BYE from NUT to P-CSCF

See generic_200-BYE

- Header Field:

* P-Access-Network-Info

UE SHALL insert a P-Access-Network-Info header into any request for a dialog, any subsequent request (except ACK requests and CANCEL requests) or response (except CANCEL responses) within a dialog or any request for a standalone method[TS24229-5.1-396]

UE SHALL insert a P-Access-Network-Info header into any response to a request for a dialog, any subsequent request (except CANCEL requests) or response (except CANCEL responses) within a dialog or any response to a standalone method.[TS24229-5.1-447]

- Sigcomp behavior:

UE SHOULD compress the requests and responses if UE generates these containing a P-Access-Network-Info header with a value of "3GPP-GERAN", "3GPP-UTRAN-FDD", "3GPP-UTRAN-TDD", "3GPP-E-UTRAN-FDD", "3GPP-E-UTRAN-TDD", "3GPP2-1X", "3GPP2-1X-HRPD", "3GPP2-UMB", "IEEE-802.11", "IEEE-802.11a", "IEEE-802.11b" or IEEE-802.11g", or "IEEE-802.11n".[TS24229-8.1-11]

If the topmost Via header field contains the parameter comp=sigcomp, the response SHOULD be compressed.[RFC3486-5-1]

*6: 17 200 OK to NOTIFY from NUT to P-CSCF

See generic_200-NOTIFY

- Header Field:

* P-Access-Network-Info

UE SHALL insert a P-Access-Network-Info header into any request for a dialog, any subsequent request (except ACK requests and CANCEL requests) or response (except CANCEL responses) within a dialog or any request for a standalone method[TS24229-5.1-396]

UE SHALL insert a P-Access-Network-Info header into any response to



a request for a dialog, any subsequent request (except CANCEL requests) or response (except CANCEL responses) within a dialog or any response to a standalone method.[TS24229-5.1-447]

- Sigcomp behavior:

UE SHOULD compress the requests and responses if UE generates these containing a P-Access-Network-Info header with a value of "3GPP-GERAN", "3GPP-UTRAN-FDD", "3GPP-UTRAN-TDD", "3GPP-E-UTRAN-FDD", "3GPP-E-UTRAN-TDD", "3GPP2-1X", "3GPP2-1X-HRPD", "3GPP2-UMB", "IEEE-802.11", "IEEE-802.11a", "IEEE-802.11b" or IEEE-802.11g", or "IEEE-802.11n".[TS24229-8.1-11]

If the topmost Via header field contains the parameter comp=sigcomp, the response SHOULD be compressed.[RFC3486-5-1]

*7: 19 No response or send NACK

- Sigcomp behavior:

UE SHALL finish the compartment when the UE is deregistered.
[TS24229-8.1-6]

4.8.2 UE-SC-B-2-AKA - SigComp for IMS (Receive INVITE and send BYE)

[NAME]

UE-SC-B-2-AKA - SigComp for IMS (Receive INVITE and send BYE)

[TARGET]

IMS User Equipment (NUT)

[PURPOSE]

To verify that the UEa1 properly uses SigComp to signaling.

(1)To verify that the UEa1 properly compress SIP messages.

(2)To verify that the UEa1 properly decompress compressed messages.

[REFERENCE]

TS24.229 8.1.2

TS24.229 8.1.3



RFC3486 4
RFC3486 5
RFC5049 9.1
RFC5049 9.4

[REQUIREMENT]
NONE

[PARAMETER(NUT)]

public-user-id : sip:UEa1_public_1@under.test.com
private-user-id : UEa1_private@under.test.com
Contact_URI : sip:UEa1_public_1@node.under.test.com
HOMENETWORK Domain : sip:under.test.com

[PARAMETER(TESTER)]

P-CSCFa1 : sip:p.a1.under.test.com
S-CSCFa1 : sip:s.a1.under.test.com
public-URI(UEa2) : sip:UEa2_public_1@under.test.com

[ADDRESS]

UEa1(NUT) : 3ffe:501:ffff:1000::1000
Router(R1) : 3ffe:501:ffff:1000::1
P-CSCFa1 : 3ffe:501:ffff:100::10
I-CSCFa1 : 3ffe:501:ffff:100::20
S-CSCFa1 : 3ffe:501:ffff:100::30
DNS : 3ffe:501:ffff:100::40
DHCP : 3ffe:501:ffff:100::50

UEa2 : 3ffe:501:ffff:2000::1000
P-CSCFa2 : 3ffe:501:ffff:200::10
I-CSCFa2 : 3ffe:501:ffff:200::20
S-CSCFa2 : 3ffe:501:ffff:200::30

[TOPOLOGY]

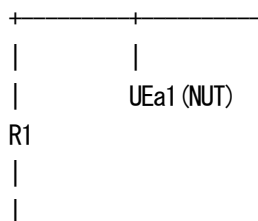

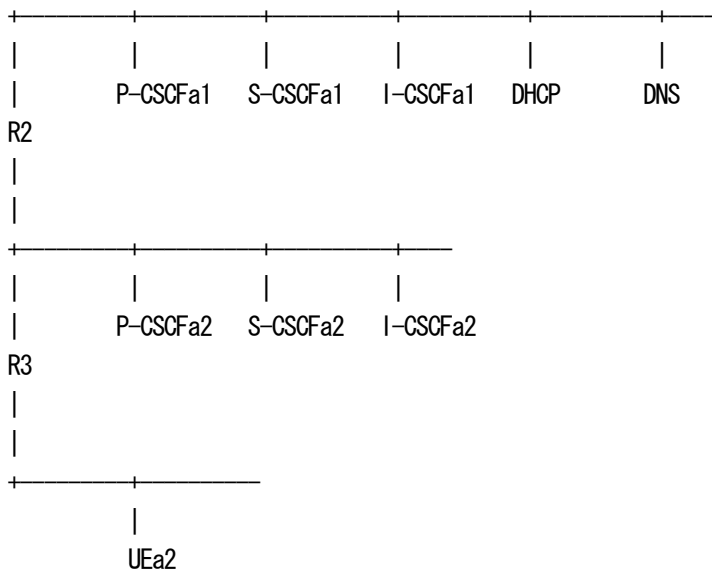

[INITIALIZATION]

Set up IP Address using A or B.

A. Router Advertisement

B. DHCPv6

(NUT)

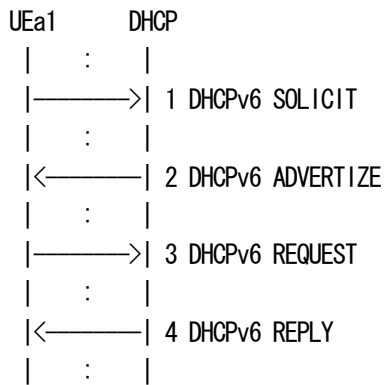

[PROCEDURE]

Home Network

(NUT)

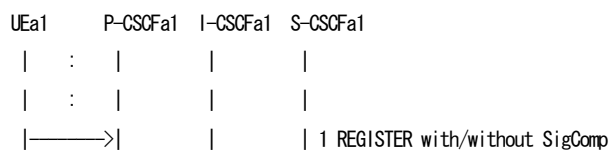



```

| : | | |
| : |----->| | REGISTER
| : | | |
| : | |----->| REGISTER
| : | | |
| : | |----->| 401 Unauthorized
| : | | |
| : |----->| 401 Unauthorized
| : | | |
|----->| | | 2 401 Unauthorized with/without SigComp
| : | | |
|----->| | | 3 REGISTER with/without SigComp
| : | | |
| : |----->| REGISTER
| : | | |
| : | |----->| REGISTER
| : | | |
| : | |----->| 200 OK
| : | | |
| : |----->| 200 OK
| : | | |
|----->| | | 4 200 OK with/without SigComp
| : | | |
|----->| | | 5 SUBSCRIBE with SigComp
| : | | |
| : |----->| SUBSCRIBE
| : | | |
| : |----->| 200 OK
| : | | |
|----->| | | 6 200 OK with SigComp
| : | | |
| : |----->| NOTIFY
| : | | |
|----->| | | 7 NOTIFY with SigComp
| : | | |
|----->| | | 8 200 OK with SigComp
| : | | |
| : |----->| 200 OK
| : | | |
| : | | | | I-CSCFa2 S-CSCFa2 P-CSCFa2 UEa2
| : | | | | | | |----->| INVITE
| : | | | | | | |

```

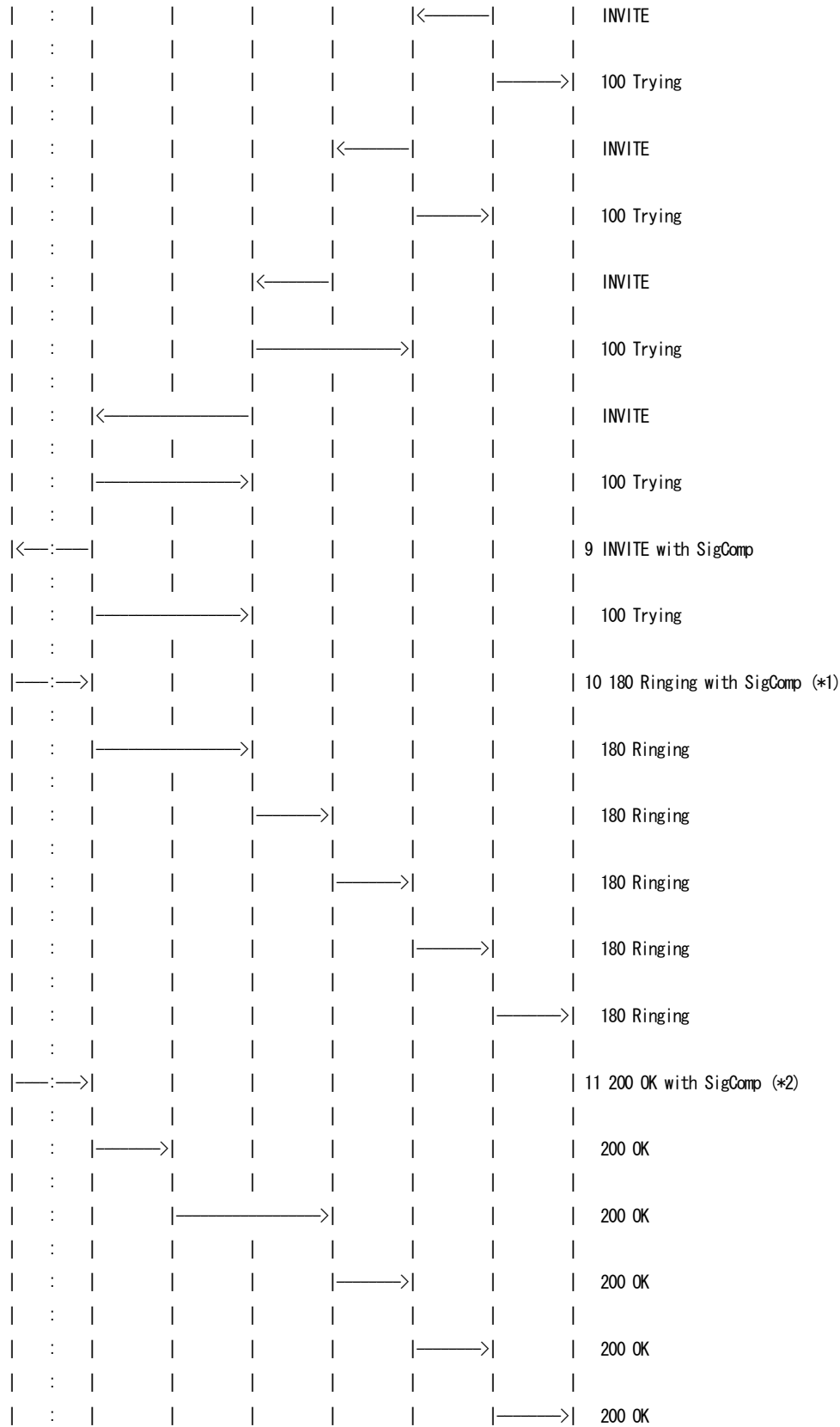

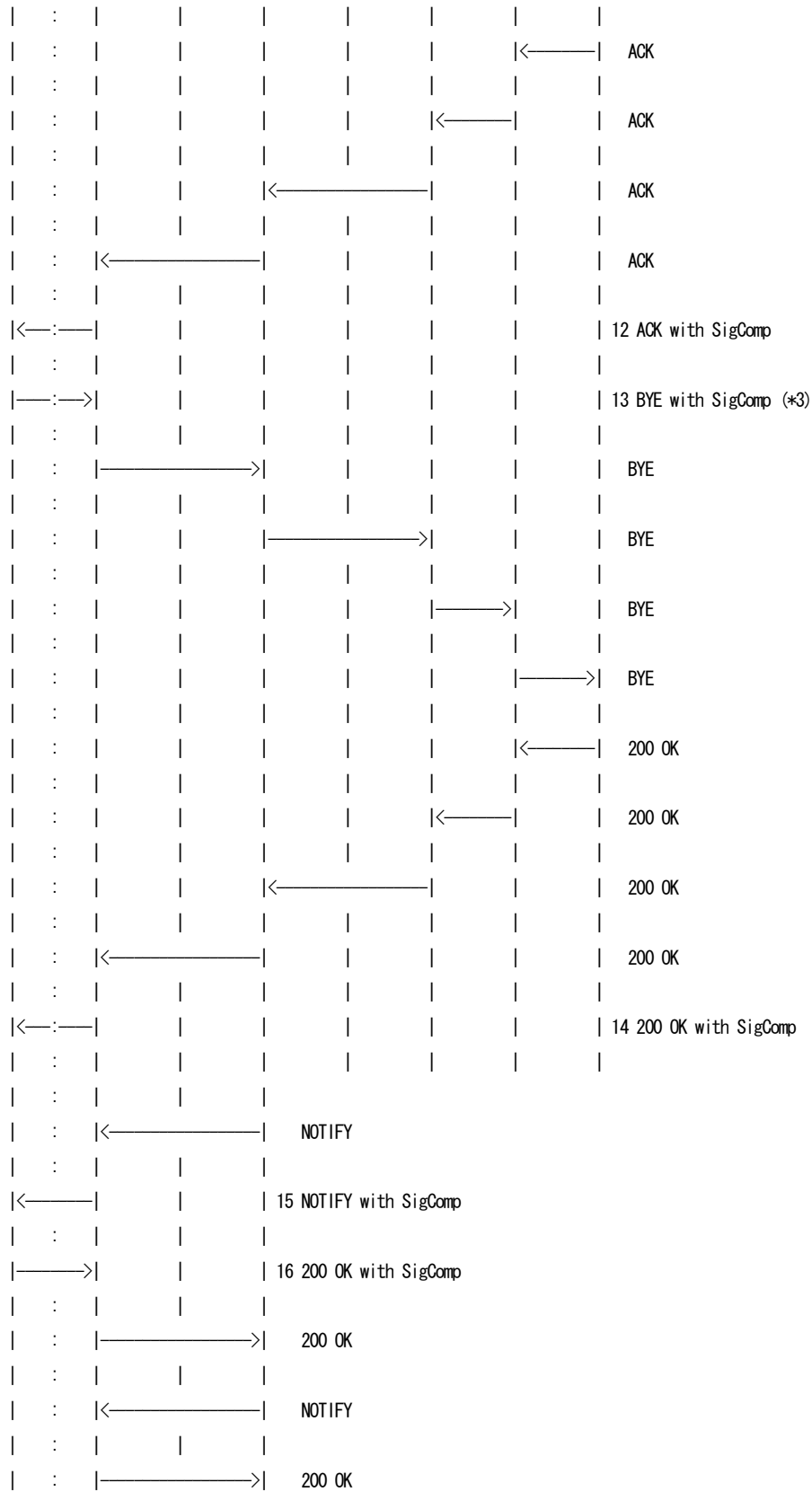



- 1 NUT sends REGISTER with/without SigComp
- 2 NUT receives 401 Unauthorized with/without SigComp
- 3 NUT sends REGISTER with/without SigComp
- 4 NUT receives 200 OK with/without SigComp
- 5 NUT sends SUBSCRIBE with SigComp
- 6 NUT receives 200 OK with SigComp
- 7 NUT receives NOTIFY with SigComp
- 8 NUT sends 200 OK with SigComp
- 9 NUT receives INVITE with SigComp
- 10 NUT sends 180 Ringing with SigComp
- 11 NUT sends 200 OK with SigComp
- 12 NUT receives ACK with SigComp
- 13 NUT sends BYE with SigComp
- 14 NUT receives 200 OK with SigComp
- 15 NUT receives NOTIFY with SigComp
- 16 NUT sends 200 OK with SigComp

=== Message example ===

As regards the message 1-8, please refer to the message 1-8 in UE-SC-B-1-AKA.

9. INVITE P-CSCFa1 -> NUT

```
INVITE sip:UEa1_public_1@node.under.test.com:1357;
comp=sigcomp;sigcomp-id=urn:uuid:00ffde92-0916-1952-2008fa82a473 SIP/2.0
Via: SIP/2.0/UDP p.a1.under.test.com:10001;branch=z9hG4bK431e418c233;
comp=sigcomp;sigcomp-id="urn:uuid:11edab92-0916-1952-2008ec24b5678",SIP/2.0/UDP
s.a1.under.test.com;branch=z9hG4bK431e418c4.2;received=3ffe:501:ffff:100::30,SIP/2.0/UDP
i.a1.under.test.com;branch=z9hG4bKnashds7;received=3ffe:501:ffff:100::20,SIP/2.0/UDP
s.a2.under.test.com;branch=z9hG4bK721e418c657u;received=3ffe:501:ffff:200::30,SIP/2.0/UDP
p.a2.under.test.com;branch=z9hG4bKnaghc45;received=3ffe:501:ffff:200::10,SIP/2.0/UDP
[3ffe:501:ffff:2000::1000]:22222;branch=z9hG4bKnashds7
Record-Route: <sip:p.a1.under.test.com:10001;lr;comp=sigcomp;sigcomp-id=urn:
uuid:11edab92-0916-1952-2008ec24b5678>,<sip:s.a1.under.test.com;lr>,
<sip:s.a2.under.test.com;lr>,<sip:p.a2.under.test.com;lr>
Max-Forwards: 65
From: <sip:UEa2_public_1@under.test.com>;tag=9fxced76sl
To: <sip:UEa1_public_1@under.test.com>
Call-ID: 3848276298220188511@under.test.com
CSeq: 1 INVITE
Contact: <sip:UEa2_public_1@nodea2.under.test.com:22222>
```



Content-Type: application/sdp
Supported:
Allow: INVITE,ACK,CANCEL,OPTIONS,BYE
Allow-Events: reg
Accept: application/sdp,application/3gpp-ims+xml
P-Called-Party-ID: <sip:UEa1_public_1@under.test.com>
Content-Length: 154

v=0
o=UEa2 2890844526 2890844526 IN IP6 nodea2.under.test.com
s=-
c=IN IP6 nodea2.under.test.com
t=0 0
m=audio 49172 RTP/AVP 0
b=AS:75
a=rtpmap:0 PCMU/8000

10. 180 Ringing NUT -> P-CSCFa1

SIP/2.0 180 Ringing

Via: SIP/2.0/UDP p.a1.under.test.com:10001;branch=z9hG4bK431e418c233;
comp=sigcomp;sigcomp-id="urn:uuid:11edab92-0916-1952-2008ec24b5678";
received=3ffe:501:ffff:100::10,SIP/2.0/UDP s.a1.under.test.com;branch=z9hG4bK431e418c4.2;
received=3ffe:501:ffff:100::30,SIP/2.0/UDP i.a1.under.test.com;branch=z9hG4bKnashds7;
received=3ffe:501:ffff:100::20,SIP/2.0/UDP s.a2.under.test.com;branch=z9hG4bK721e418c657u;
received=3ffe:501:ffff:200::30,SIP/2.0/UDP p.a2.under.test.com;branch=z9hG4bKnaghc45;
received=3ffe:501:ffff:200::10,SIP/2.0/UDP [3ffe:501:ffff:2000::1000]:22222;branch=z9hG4bKnashds7
From: <sip:UEa2_public_1@under.test.com>;tag=9fxced76sl
To: <sip:UEa1_public_1@under.test.com>;tag=2i3rjojpg2hopr
Call-ID: 3848276298220188511@under.test.com
CSeq: 1 INVITE
P-Access-Network-Info: 3GPP-UTRAN-TDD;utran-cell-id-3gpp=123456A1BDS23
Content-Length: 0

11. 200 OK NUT -> P-CSCFa1

SIP/2.0 200 OK

Via: SIP/2.0/UDP p.a1.under.test.com:10001;branch=z9hG4bK431e418c233;
comp=sigcomp;sigcomp-id="urn:uuid:11edab92-0916-1952-2008ec24b5678";
received=3ffe:501:ffff:100::10,SIP/2.0/UDP s.a1.under.test.com;branch=z9hG4bK431e418c4.2;
received=3ffe:501:ffff:100::30,SIP/2.0/UDP i.a1.under.test.com;branch=z9hG4bKnashds7;
received=3ffe:501:ffff:100::20,SIP/2.0/UDP s.a2.under.test.com;branch=z9hG4bK721e418c657u;
received=3ffe:501:ffff:200::30,SIP/2.0/UDP p.a2.under.test.com;branch=z9hG4bKnaghc45;



received=3ffe:501:ffff:200::10,SIP/2.0/UDP [3ffe:501:ffff:2000::1000]:22222;branch=z9hG4bKnashds7
Record-Route: <sip:p.a1.under.test.com:10001;lr;comp=sigcomp;
sigcomp-id=urn:uuid:11edab92-0916-1952-2008ec24b5678>,
<sip:s.a1.under.test.com;lr>,<sip:s.a2.under.test.com;lr>,<sip:p.a2.under.test.com;lr>
From: <sip:UEa2_public_1@under.test.com>;tag=9fxced76sl
To: <sip:UEa1_public_1@under.test.com>;tag=2i3rjojgp2hopr
Call-ID: 3848276298220188511@under.test.com
CSeq: 1 INVITE
Contact: <sip:UEa1_public_1@node.under.test.com:1357;
comp=sigcomp;sigcomp-id=urn:uuid:00ffde92-0916-1952-2008fa82a473>
Supported:
Allow: INVITE,ACK,CANCEL,OPTIONS,BYE
Allow-Events: reg
P-Access-Network-Info: 3GPP-UTRAN-TDD;utran-cell-id-3gpp=123456A1BDS23
Content-Type: application/sdp
Content-Length: 153

v=0
o=UEa1 2890844526 2890844526 IN IP6 node.under.test.com
s=-
c=IN IP6 node.under.test.com
t=0 0
m=audio 3456 RTP/AVP 0
b=AS:75
a=rtpmap:0 PCMU/8000

12. ACK P-CSCFa1 -> NUT

ACK sip:UEa1_public_1@node.under.test.com:1357;
comp=sigcomp;sigcomp-id=urn:uuid:00ffde92-0916-1952-2008fa82a473 SIP/2.0
Via: SIP/2.0/UDP p.a1.under.test.com:10001;branch=z9hG4bK431e418c233;
comp=sigcomp;sigcomp-id="urn:uuid:11edab92-0916-1952-2008ec24b5678",SIP/2.0/UDP
s.a1.under.test.com;branch=z9hG4bK431e418c4.2;received=3ffe:501:ffff:100::30,SIP/2.0/UDP
s.a2.under.test.com;branch=z9hG4bK721e418c657u;received=3ffe:501:ffff:200::30,SIP/2.0/UDP
p.a2.under.test.com;branch=z9hG4bKnaghc45;received=3ffe:501:ffff:200::10,SIP/2.0/UDP
[3ffe:501:ffff:2000::1000]:22222;branch=z9hG4bKnashds7
Max-Forwards: 66
From: <sip:UEa2_public_1@under.test.com>;tag=9fxced76sl
To: <sip:UEa1_public_1@under.test.com>;tag=314159
Call-ID: 3848276298220188511@under.test.com
CSeq: 1 ACK
Content-Length: 0



13. BYE NUT -> P-CSCFa1

BYE sip:UEa2_public_1@nodea2.under.test.com:22222 SIP/2.0

Via: SIP/2.0/UDP [3ffe:501:ffff:1000::1000]:1357;branch=z9hG4bKnashlpswmpf;
comp=sigcomp;sigcomp-id="urn:uuid:00ffde92-0916-1952-2008fa82a473"

Route: <sip:p.a1.under.test.com:10001;lr;comp=sigcomp;sigcomp-id=urn:uuid:
11edab92-0916-1952-2008ec24b5678>,<sip:s.a1.under.test.com;lr>,
<sip:s.a2.under.test.com;lr>,<sip:p.a2.under.test.com;lr>

Max-Forwards: 70

From: <sip:UEa1_public_1@under.test.com>;tag=9fxced76sl

To: <sip:UEa2_public_1@under.test.com>;tag=314159

Call-ID: 3848276298220188511@under.test.com

CSeq: 2 BYE

Security-Verify: ipsec-3gpp; alg=hmac-sha-1-96; spi-c=256; spi-s=257; port-c=10002; port-s=10001

Require: sec-agree

Proxy-Require: sec-agree

P-Access-Network-Info: 3GPP-UTRAN-TDD;utran-cell-id-3gpp=123456A1BDS23

Content-Length: 0

14. 200 OK P-CSCFa1 -> NUT

SIP/2.0 200 OK

Via: SIP/2.0/UDP [3ffe:501:ffff:1000::1000]:1357;branch=z9hG4bKnashlpswmpf;comp=sigcomp;
sigcomp-id="urn:uuid:00ffde92-0916-1952-2008fa82a473"

From: <sip:UEa1_public_1@under.test.com>;tag=9fxced76sl

To: <sip:UEa2_public_1@under.test.com>;tag=314159

Call-ID: 3848276298220188511@under.test.com

CSeq: 2 BYE

Content-Length: 0

15. NOTIFY P-CSCFa1 -> NUT

NOTIFY sip:UEa1_public_1@node.under.test.com:1357;comp=sigcomp;sigcomp-id=urn:
uuid:00ffde92-0916-1952-2008fa82a473 SIP/2.0

Via: SIP/2.0/UDP p.a1.under.test.com:10001;branch=z9hG4bK240f34.1;
comp=sigcomp;sigcomp-id="urn:uuid:11edab92-0916-1952-2008ec24b5678",SIP/2.0/UDP
s.a1.under.test.com;branch=z9hG4bK332b23.1;received=3ffe:501:ffff:100::30

Max-Forwards: 69

From: <sip:UEa1_public_1@under.test.com>;tag=151170

To: <sip:UEa1_public_1@under.test.com>;tag=31415

Call-ID: b89rjhnedlrjflslj40a222@under.test.com

CSeq: 43 NOTIFY

Subscription-State: terminated



Event: reg
Content-Type: application/reginfo+xml
Contact: <sip:s.a1.under.test.com>
Content-Length: (...)

```
<?xml version="1.0"?>
<reginfo xmlns="urn:ietf:params:xml:ns:reginfo" version="1" state="full">
  <registration aor="sip:UEa1_public_1@under.test.com" id="as9" state="terminated">
    <contact id="76" state="terminated" event="rejected">
      <uri>sip:UEa1_public_1@node.under.test.com</uri>
    </contact>
  </registration>
</reginfo>
```

16. 200 OK NUT -> P-CSCFa1
SIP/2.0 200 OK
Via: SIP/2.0/UDP p.a1.under.test.com:10001;branch=z9hG4bK240f34.1;
comp=sigcomp;sigcomp-id="urn:uuid:11edab92-0916-1952-2008ec24b5678";
received=3ffe:501:ffff:100::10,SIP/2.0/UDP s.a1.under.test.com;branch=z9hG4bK332b23.1;
received=3ffe:501:ffff:100::30
From: <sip:UEa1_public_1@under.test.com>;tag=151170
To: <sip:UEa1_public_1@under.test.com>;tag=31415
Call-ID: b89rjhnedlrfjflsj40a222@under.test.com
CSeq: 43 NOTIFY
P-Access-Network-Info: 3GPP-UTRAN-TDD;utran-cell-id-3gpp=123456A1BDS23
Content-Length: 0

[OBSERVABLE RESULTS]

*1: 10 180 Ringing from NUT to P-CSCF

See generic_180-INVITE

- Header Field:

* P-Access-Network-Info

UE SHALL insert a P-Access-Network-Info header into any request for a dialog, any subsequent request (except ACK requests and CANCEL requests) or response (except CANCEL responses) within a dialog or any request for a standalone method[TS24229-5.1-396]



UE SHALL insert a P-Access-Network-Info header into any response to a request for a dialog, any subsequent request (except CANCEL requests) or response (except CANCEL responses) within a dialog or any response to a standalone method.[TS24229-5.1-447]

- Sigcomp behavior:

UE SHOULD compress the requests and responses if UE generates these containing a P-Access-Network-Info header with a value of "3GPP-GERAN", "3GPP-UTRAN-FDD", "3GPP-UTRAN-TDD", "3GPP-E-UTRAN-FDD", "3GPP-E-UTRAN-TDD", "3GPP2-1X", "3GPP2-1X-HRPD", "3GPP2-UMB", "IEEE-802.11", "IEEE-802.11a", "IEEE-802.11b" or IEEE-802.11g", or "IEEE-802.11n".[TS24229-8.1-11]

If the topmost Via header field contains the parameter comp=sigcomp, the response SHOULD be compressed.[RFC3486-5-1]

*2: 11 200 OK from NUT to P-CSCF

See generic_200-INVITE

- Header Field:

* Contact

UE SHOULD add comp=sigcomp to the Contact header field of the response if the URI of the next upstream hop in the route set contained the parameter comp=sigcomp.[RFC3486-5-5]

A SIP/SigComp application placing its URI with the 'comp=sigcomp' parameter in a header field MUST add a 'sigcomp-id' parameter with its SIP/SigComp identifier to that URI.[RFC5049-9.1-9]

The SIP URI 'sigcomp-id' parameter MUST contain a URN [RFC2141]. [RFC5049-9.1-7]

URN MUST be persistent as long as the application stores compartment state related to other SIP/SigComp applications.[RFC5049-9.1-2]

* P-Access-Network-Info

UE SHALL insert a P-Access-Network-Info header into any request for a dialog, any subsequent request (except ACK requests and CANCEL requests) or response (except CANCEL responses) within a dialog or any request for a standalone method[TS24229-5.1-396]



UE SHALL insert a P-Access-Network-Info header into any response to a request for a dialog, any subsequent request (except CANCEL requests) or response (except CANCEL responses) within a dialog or any response to a standalone method.[TS24229-5.1-447]

- Sigcomp behavior:

UE SHOULD compress the requests and responses if UE generates these containing a P-Access-Network-Info header with a value of "3GPP-GERAN", "3GPP-UTRAN-FDD", "3GPP-UTRAN-TDD", "3GPP-E-UTRAN-FDD", "3GPP-E-UTRAN-TDD", "3GPP2-1X", "3GPP2-1X-HRPD", "3GPP2-UMB", "IEEE-802.11", "IEEE-802.11a", "IEEE-802.11b" or IEEE-802.11g", or "IEEE-802.11n".[TS24229-8.1-11]

If the topmost Via header field contains the parameter comp=sigcomp, the response SHOULD be compressed.[RFC3486-5-1]

*3: 13 BYE from NUT to P-CSCF

See generic_BYE

- Header Field:

* P-Access-Network-Info

UE SHALL insert a P-Access-Network-Info header into any request for a dialog, any subsequent request (except ACK requests and CANCEL requests) or response (except CANCEL responses) within a dialog or any request for a standalone method[TS24229-5.1-396]

* Via

If UE sends a compressed request, UE SHOULD add the parameter comp=sigcomp to the topmost entry of the Via header field.
[RFC3486-4-8]

A SIP/SigComp application generating its own Via entry containing the 'comp=sigcomp' parameter MUST add a 'sigcomp-id' parameter with its SIP/SigComp identifier to that Via entry.[RFC5049-9.1-10]

The Via 'sigcomp-id' parameter MUST contain a URN [RFC2141].
[RFC5049-9.1-8]

URN MUST be persistent as long as the application stores compartment state related to other SIP/SigComp applications.[RFC5049-9.1-2]



- Sigcomp behavior:

UE SHOULD compress the requests and responses if UE generates these containing a P-Access-Network-Info header with a value of "3GPP-GERAN", "3GPP-UTRAN-FDD", "3GPP-UTRAN-TDD", "3GPP-E-UTRAN-FDD", "3GPP-E-UTRAN-TDD", "3GPP2-1X", "3GPP2-1X-HRPD", "3GPP2-UMB", "IEEE-802.11", "IEEE-802.11a", "IEEE-802.11b" or IEEE-802.11g", or "IEEE-802.11n".[TS24229-8.1-11]

If the next-hop URI contains the parameter comp=sigcomp, the UE SHOULD compress the request using SigComp.[RFC3486-4-1][RFC5049-9.4-1]

Appendix Mapping table

Following number described in "OBSERVABLE RESULTS" corresponds to the section number of reference documents. e.g.) TS24229-5.1-41 -> TS24.229 5.1.1.2.1

NO.	Reference	NO.	Reference	NO.	Reference	NO.	Reference
TS24229-4.1-1	TS24.229 4.1	TS24229-4.1-37	TS24.229 4.1	TS24229-4.4-13	TS24.229 4.4.10	TS24229-5.1-12	TS24.229 5.1.1.1A
TS24229-4.1-2	TS24.229 4.1	TS24229-4.1-38	TS24.229 4.1	TS24229-4.4-14	TS24.229 4.4.10	TS24229-5.1-13	TS24.229 5.1.1.1A
TS24229-4.1-3	TS24.229 4.1	TS24229-4.1-39	TS24.229 4.1	TS24229-4.4-15	TS24.229 4.4.10	TS24229-5.1-14	TS24.229 5.1.1.1A
TS24229-4.1-4	TS24.229 4.1	TS24229-4.2-1	TS24.229 4.2	TS24229-4.4-16	TS24.229 4.4.10	TS24229-5.1-15	TS24.229 5.1.1.1A
TS24229-4.1-5	TS24.229 4.1	TS24229-4.2-2	TS24.229 4.2	TS24229-4.5-1	TS24.229 4.5.3.2	TS24229-5.1-16	TS24.229 5.1.1.1A
TS24229-4.1-6	TS24.229 4.1	TS24229-4.2-3	TS24.229 4.2	TS24229-4.5-2	TS24.229 4.5.4	TS24229-5.1-17	TS24.229 5.1.1.1B.1
TS24229-4.1-7	TS24.229 4.1	TS24229-4.2-4	TS24.229 4.2	TS24229-4.5-3	TS24.229 4.5.4	TS24229-5.1-18	TS24.229 5.1.1.1B.1
TS24229-4.1-8	TS24.229 4.1	TS24229-4.2-5	TS24.229 4.2	TS24229-4.5-4	TS24.229 4.5.5	TS24229-5.1-19	TS24.229 5.1.1.1B.2
TS24229-4.1-9	TS24.229 4.1	TS24229-4.2-6	TS24.229 4.2	TS24229-4.5-5	TS24.229 4.5.5	TS24229-5.1-20	TS24.229 5.1.1.2.1
TS24229-4.1-10	TS24.229 4.1	TS24229-4.2-7	TS24.229 4.2	TS24229-4.5-6	TS24.229 4.5.5	TS24229-5.1-21	TS24.229 5.1.1.2.1
TS24229-4.1-11	TS24.229 4.1	TS24229-4.2-8	TS24.229 4.2	TS24229-4.5-7	TS24.229 4.5.5	TS24229-5.1-22	TS24.229 5.1.1.2.1
TS24229-4.1-12	TS24.229 4.1	TS24229-4.2-9	TS24.229 4.2	TS24229-4.5-8	TS24.229 4.5.5	TS24229-5.1-23	TS24.229 5.1.1.2.1
TS24229-4.1-13	TS24.229 4.1	TS24229-4.2-10	TS24.229 4.2	TS24229-4.7-1	TS24.229 4.7	TS24229-5.1-24	TS24.229 5.1.1.2.1
TS24229-4.1-14	TS24.229 4.1	TS24229-4.2-11	TS24.229 4.2	TS24229-4.7-2	TS24.229 4.7	TS24229-5.1-25	TS24.229 5.1.1.2.1
TS24229-4.1-15	TS24.229 4.1	TS24229-4.2-12	TS24.229 4.2A	TS24229-4.8-1	TS24.229 4.8.1	TS24229-5.1-26	TS24.229 5.1.1.2.1
TS24229-4.1-16	TS24.229 4.1	TS24229-4.2-13	TS24.229 4.2A	TS24229-4.9-1	TS24.229 4.9.1	TS24229-5.1-27	TS24.229 5.1.1.2.1
TS24229-4.1-17	TS24.229 4.1	TS24229-4.2-14	TS24.229 4.2A	TS24229-4.9-2	TS24.229 4.9.3.1	TS24229-5.1-28	TS24.229 5.1.1.2.1
TS24229-4.1-18	TS24.229 4.1	TS24229-4.2-15	TS24.229 4.2A	TS24229-4.9-3	TS24.229 4.9.3.1	TS24229-5.1-29	TS24.229 5.1.1.2.1
TS24229-4.1-19	TS24.229 4.1	TS24229-4.2-16	TS24.229 4.2B	TS24229-4.9-4	TS24.229 4.9.3.2	TS24229-5.1-30	TS24.229 5.1.1.2.1
TS24229-4.1-20	TS24.229 4.1	TS24229-4.2-17	TS24.229 4.2B	TS24229-4.9-5	TS24.229 4.9.3.3	TS24229-5.1-31	TS24.229 5.1.1.2.1
TS24229-4.1-21	TS24.229 4.1	TS24229-4.2-18	TS24.229 4.2B	TS24229-4.9-6	TS24.229 4.9.3.3	TS24229-5.1-32	TS24.229 5.1.1.2.1
TS24229-4.1-22	TS24.229 4.1	TS24229-4.2-19	TS24.229 4.2B	TS24229-4.9-7	TS24.229 4.9.3.3	TS24229-5.1-33	TS24.229 5.1.1.2.1
TS24229-4.1-23	TS24.229 4.1	TS24229-4.3-1	TS24.229 4.3	TS24229-4.9-8	TS24.229 4.9.3.3	TS24229-5.1-34	TS24.229 5.1.1.2.1
TS24229-4.1-24	TS24.229 4.1	TS24229-4.3-2	TS24.229 4.3	TS24229-4.9-9	TS24.229 4.9.3.3	TS24229-5.1-35	TS24.229 5.1.1.2.1
TS24229-4.1-25	TS24.229 4.1	TS24229-4.4-1	TS24.229 4.4.1	TS24229-4.9-10	TS24.229 4.9.3.3	TS24229-5.1-36	TS24.229 5.1.1.2.1
TS24229-4.1-26	TS24.229 4.1	TS24229-4.4-2	TS24.229 4.4.1	TS24229-5.1-1	TS24.229 5.1.0	TS24229-5.1-37	TS24.229 5.1.1.2.1
TS24229-4.1-27	TS24.229 4.1	TS24229-4.4-3	TS24.229 4.4.1	TS24229-5.1-2	TS24.229 5.1.1.1	TS24229-5.1-38	TS24.229 5.1.1.2.1
TS24229-4.1-28	TS24.229 4.1	TS24229-4.4-4	TS24.229 4.4.1	TS24229-5.1-3	TS24.229 5.1.1.1	TS24229-5.1-39	TS24.229 5.1.1.2.1
TS24229-4.1-29	TS24.229 4.1	TS24229-4.4-5	TS24.229 4.4.3	TS24229-5.1-4	TS24.229 5.1.1.1	TS24229-5.1-40	TS24.229 5.1.1.2.1
TS24229-4.1-30	TS24.229 4.1	TS24229-4.4-6	TS24.229 4.4.6	TS24229-5.1-5	TS24.229 5.1.1.1	TS24229-5.1-41	TS24.229 5.1.1.2.1
TS24229-4.1-31	TS24.229 4.1	TS24229-4.4-7	TS24.229 4.4.6	TS24229-5.1-6	TS24.229 5.1.1.1	TS24229-5.1-42	TS24.229 5.1.1.2.1
TS24229-4.1-32	TS24.229 4.1	TS24229-4.4-8	TS24.229 4.4.6	TS24229-5.1-7	TS24.229 5.1.1.1	TS24229-5.1-43	TS24.229 5.1.1.2.1
TS24229-4.1-33	TS24.229 4.1	TS24229-4.4-9	TS24.229 4.4.7	TS24229-5.1-8	TS24.229 5.1.1.1	TS24229-5.1-44	TS24.229 5.1.1.2.1
TS24229-4.1-34	TS24.229 4.1	TS24229-4.4-10	TS24.229 4.4.7	TS24229-5.1-9	TS24.229 5.1.1.1	TS24229-5.1-45	TS24.229 5.1.1.2.1
TS24229-4.1-35	TS24.229 4.1	TS24229-4.4-11	TS24.229 4.4.7	TS24229-5.1-10	TS24.229 5.1.1.1	TS24229-5.1-46	TS24.229 5.1.1.2.1
TS24229-4.1-36	TS24.229 4.1	TS24229-4.4-12	TS24.229 4.4.10	TS24229-5.1-11	TS24.229 5.1.1.1A	TS24229-5.1-47	TS24.229 5.1.1.2.1



NO.	Reference	NO.	Reference	NO.	Reference	NO.	Reference
TS24229-7.2A-29	TS24.229 7.2A.8.2	TS24229-7.2A-41	TS24.229 7.2A.10.3	TS24229-7.6-6	TS24.229 7.6.3	TS24229-8.1-2	TS24.229 8.1.1
TS24229-7.2A-30	TS24.229 7.2A.8.2	TS24229-7.2A-42	TS24.229 7.2A.10.3	TS24229-7.6-7	TS24.229 7.6.4.1	TS24229-8.1-3	TS24.229 8.1.1
TS24229-7.2A-31	TS24.229 7.2A.9.2	TS24229-7.2A-43	TS24.229 7.2A.10.3	TS24229-7.6-8	TS24.229 7.6.4.3	TS24229-8.1-4	TS24.229 8.1.1
TS24229-7.2A-32	TS24.229 7.2A.9.2	TS24229-7.2A-44	TS24.229 7.2A.10.3	TS24229-7.6-9	TS24.229 7.6.4.3	TS24229-8.1-5	TS24.229 8.1.1
TS24229-7.2A-33	TS24.229 7.2A.9.2	TS24229-7.2A-45	TS24.229 7.2A.10.3	TS24229-7.6-10	TS24.229 7.6.5	TS24229-8.1-6	TS24.229 8.1.1
TS24229-7.2A-34	TS24.229 7.2A.10.3	TS24229-7.2A-46	TS24.229 7.2A.10.3	TS24229-7.6-11	TS24.229 7.6.5	TS24229-8.1-7	TS24.229 8.1.1
TS24229-7.2A-35	TS24.229 7.2A.10.3	TS24229-7.2A-47	TS24.229 7.2A.10.3	TS24229-7.7-1	TS24.229 7.7	TS24229-8.1-8	TS24.229 8.1.1
TS24229-7.2A-36	TS24.229 7.2A.10.3	TS24229-7.6-1	TS24.229 7.6.1	TS24229-7.7-2	TS24.229 7.7	TS24229-8.1-9	TS24.229 8.1.1
TS24229-7.2A-37	TS24.229 7.2A.10.3	TS24229-7.6-2	TS24.229 7.6.1	TS24229-7.8-1	TS24.229 7.8	TS24229-8.1-10	TS24.229 8.1.1
TS24229-7.2A-38	TS24.229 7.2A.10.3	TS24229-7.6-3	TS24.229 7.6.1	TS24229-7.9-1	TS24.229 7.9.2	TS24229-8.1-11	TS24.229 8.1.2
TS24229-7.2A-39	TS24.229 7.2A.10.3	TS24229-7.6-4	TS24.229 7.6.3	TS24229-7.9-2	TS24.229 7.9.3	TS24229-8.1-12	TS24.229 8.1.2
TS24229-7.2A-40	TS24.229 7.2A.10.3	TS24229-7.6-5	TS24.229 7.6.3	TS24229-8.1-1	TS24.229 8.1.1	TS24229-8.1-13	TS24.229 8.1.3



NO.	Reference	NO.	Reference	NO.	Reference	NO.	Reference
TS33203-4-1	TS33.203 4	TS33203-6.1-2	TS33.203 6.1	TS33203-6.3-3	TS33.203 6.3	TS33203-7.1-29	TS33.203 7.1
TS33203-4-2	TS33.203 4	TS33203-6.1-3	TS33.203 6.1	TS33203-6.3-4	TS33.203 6.3	TS33203-7.1-30	TS33.203 7.1
TS33203-4-3	TS33.203 4	TS33203-6.1-4	TS33.203 6.1	TS33203-6.3-5	TS33.203 6.3	TS33203-7.1-31	TS33.203 7.1
TS33203-4-4	TS33.203 4	TS33203-6.1-5	TS33.203 6.1	TS33203-6.4-1	TS33.203 6.4	TS33203-7.1-32	TS33.203 7.1
TS33203-4-5	TS33.203 4	TS33203-6.1-6	TS33.203 6.1	TS33203-6.4-2	TS33.203 6.4	TS33203-7.1-33	TS33.203 7.1
TS33203-5.1-1	TS33.203 5.1.1	TS33203-6.1-7	TS33.203 6.1	TS33203-6.4-3	TS33.203 6.4	TS33203-7.1-34	TS33.203 7.1
TS33203-5.1-2	TS33.203 5.1.1	TS33203-6.1-8	TS33.203 6.1	TS33203-6.4-4	TS33.203 6.4	TS33203-7.1-35	TS33.203 7.1
TS33203-5.1-3	TS33.203 5.1.2	TS33203-6.1-9	TS33.203 6.1.1	TS33203-6.4-5	TS33.203 6.4	TS33203-7.2-1	TS33.203 7.2
TS33203-5.1-4	TS33.203 5.1.2	TS33203-6.1-10	TS33.203 6.1.1	TS33203-6.4-6	TS33.203 6.4	TS33203-7.2-2	TS33.203 7.2
TS33203-5.1-5	TS33.203 5.1.2	TS33203-6.1-11	TS33.203 6.1.1	TS33203-6.4-7	TS33.203 6.4	TS33203-7.2-3	TS33.203 7.2
TS33203-5.1-6	TS33.203 5.1.3	TS33203-6.1-12	TS33.203 6.1.1	TS33203-6.5-1	TS33.203 6.5	TS33203-7.2-4	TS33.203 7.2
TS33203-5.1-7	TS33.203 5.1.3	TS33203-6.1-13	TS33.203 6.1.1	TS33203-6.5-2	TS33.203 6.5	TS33203-7.2-5	TS33.203 7.2
TS33203-5.1-8	TS33.203 5.1.3	TS33203-6.1-14	TS33.203 6.1.1	TS33203-6.5-3	TS33.203 6.5	TS33203-7.2-6	TS33.203 7.2
TS33203-5.1-9	TS33.203 5.1.3	TS33203-6.1-15	TS33.203 6.1.1	TS33203-7.1-1	TS33.203 7.1	TS33203-7.2-7	TS33.203 7.2
TS33203-5.1-10	TS33.203 5.1.3	TS33203-6.1-16	TS33.203 6.1.1	TS33203-7.1-2	TS33.203 7.1	TS33203-7.2-8	TS33.203 7.2
TS33203-5.1-11	TS33.203 5.1.3	TS33203-6.1-17	TS33.203 6.1.1	TS33203-7.1-3	TS33.203 7.1	TS33203-7.2-9	TS33.203 7.2
TS33203-5.1-12	TS33.203 5.1.4	TS33203-6.1-18	TS33.203 6.1.1	TS33203-7.1-4	TS33.203 7.1	TS33203-7.2-10	TS33.203 7.2
TS33203-5.1-13	TS33.203 5.1.4	TS33203-6.1-19	TS33.203 6.1.1	TS33203-7.1-5	TS33.203 7.1	TS33203-7.2-11	TS33.203 7.2
TS33203-5.1-14	TS33.203 5.1.4	TS33203-6.1-20	TS33.203 6.1.1	TS33203-7.1-6	TS33.203 7.1	TS33203-7.2-12	TS33.203 7.2
TS33203-5.1-15	TS33.203 5.1.4	TS33203-6.1-21	TS33.203 6.1.1	TS33203-7.1-7	TS33.203 7.1	TS33203-7.2-13	TS33.203 7.2
TS33203-5.1-16	TS33.203 5.1.4	TS33203-6.1-22	TS33.203 6.1.2.1	TS33203-7.1-8	TS33.203 7.1	TS33203-7.3-1	TS33.203 7.3.1
TS33203-5.1-17	TS33.203 5.1.4	TS33203-6.1-23	TS33.203 6.1.2.1	TS33203-7.1-9	TS33.203 7.1	TS33203-7.3-2	TS33.203 7.3.1.1
TS33203-5.1-18	TS33.203 5.1.4	TS33203-6.1-24	TS33.203 6.1.2.1	TS33203-7.1-10	TS33.203 7.1	TS33203-7.3-3	TS33.203 7.3.1.1
TS33203-5.1-19	TS33.203 5.1.4	TS33203-6.1-25	TS33.203 6.1.2.2	TS33203-7.1-11	TS33.203 7.1	TS33203-7.3-4	TS33.203 7.3.1.1
TS33203-5.1-20	TS33.203 5.1.4	TS33203-6.1-26	TS33.203 6.1.2.2	TS33203-7.1-12	TS33.203 7.1	TS33203-7.3-5	TS33.203 7.3.1.2
TS33203-5.1-21	TS33.203 5.1.4	TS33203-6.1-27	TS33.203 6.1.2.2	TS33203-7.1-13	TS33.203 7.1	TS33203-7.3-6	TS33.203 7.3.1.3
TS33203-5.1-22	TS33.203 5.1.4	TS33203-6.1-28	TS33.203 6.1.2.2	TS33203-7.1-14	TS33.203 7.1	TS33203-7.3-7	TS33.203 7.3.1.4
TS33203-5.2-1	TS33.203 5.2	TS33203-6.1-29	TS33.203 6.1.2.3	TS33203-7.1-15	TS33.203 7.1	TS33203-7.3-8	TS33.203 7.3.1.4
TS33203-5.2-2	TS33.203 5.2	TS33203-6.1-30	TS33.203 6.1.2.3	TS33203-7.1-16	TS33.203 7.1	TS33203-7.3-9	TS33.203 7.3.1.4
TS33203-5.2-3	TS33.203 5.2	TS33203-6.1-32	TS33.203 6.1.3	TS33203-7.1-17	TS33.203 7.1	TS33203-7.3-10	TS33.203 7.3.1.4
TS33203-5.2-4	TS33.203 5.2	TS33203-6.1-33	TS33.203 6.1.3	TS33203-7.1-18	TS33.203 7.1	TS33203-7.3-11	TS33.203 7.3.2.1
TS33203-5.2-5	TS33.203 5.2	TS33203-6.1-34	TS33.203 6.1.4	TS33203-7.1-19	TS33.203 7.1	TS33203-7.3-12	TS33.203 7.3.2.1
TS33203-5.2-6	TS33.203 5.2	TS33203-6.1-35	TS33.203 6.1.4	TS33203-7.1-20	TS33.203 7.1	TS33203-7.3-13	TS33.203 7.3.2.2
TS33203-5.2-7	TS33.203 5.2	TS33203-6.1-36	TS33.203 6.1.4	TS33203-7.1-21	TS33.203 7.1	TS33203-7.3-14	TS33.203 7.3.2.3
TS33203-5.3-1	TS33.203 5.3	TS33203-6.1-37	TS33.203 6.1.4	TS33203-7.1-22	TS33.203 7.1	TS33203-7.4-1	TS33.203 7.4
TS33203-5.4-1	TS33.203 5.4	TS33203-6.2-1	TS33.203 6.2	TS33203-7.1-23	TS33.203 7.1	TS33203-7.4-2	TS33.203 7.4
TS33203-5.4-2	TS33.203 5.4	TS33203-6.2-2	TS33.203 6.2	TS33203-7.1-24	TS33.203 7.1	TS33203-7.4-3	TS33.203 7.4
TS33203-5.4-3	TS33.203 5.4	TS33203-6.2-3	TS33.203 6.2	TS33203-7.1-25	TS33.203 7.1	TS33203-7.4-4	TS33.203 7.4
TS33203-5.4-4	TS33.203 5.4	TS33203-6.2-4	TS33.203 6.2	TS33203-7.1-26	TS33.203 7.1	TS33203-7.4-5	TS33.203 7.4.1a
TS33203-5.4-5	TS33.203 5.4	TS33203-6.3-1	TS33.203 6.3	TS33203-7.1-27	TS33.203 7.1	TS33203-7.4-6	TS33.203 7.4.1a
TS33203-6.1-1	TS33.203 6.1	TS33203-6.3-2	TS33.203 6.3	TS33203-7.1-28	TS33.203 7.1	TS33203-7.4-7	TS33.203 7.4.1a



NO.	Reference	NO.	Reference	NO.	Reference	NO.	Reference
TS33203-7.4-8	TS33.203 7.4.1a	TS33203-7.4-28	TS33.203 7.4.1a	TS33203-7.4-48	TS33.203 7.4.2a	TS33203-8.1-6	TS33.203 8.1
TS33203-7.4-9	TS33.203 7.4.1a	TS33203-7.4-29	TS33.203 7.4.1a	TS33203-9-4	TS33.203 9	TS33203-8.1-7	TS33.203 8.1
TS33203-7.4-10	TS33.203 7.4.1a	TS33203-7.4-30	TS33.203 7.4.1a	TS33203-9-5	TS33.203 9	TS33203-8.1-8	TS33.203 8.1
TS33203-7.4-11	TS33.203 7.4.1a	TS33203-7.4-31	TS33.203 7.4.2a	TS33203-9-6	TS33.203 9	TS33203-8.1-9	TS33.203 8.1
TS33203-7.4-12	TS33.203 7.4.1a	TS33203-7.4-32	TS33.203 7.4.2a	TS33203-9-7	TS33.203 9	TS33203-8.1-10	TS33.203 8.1
TS33203-7.4-13	TS33.203 7.4.1a	TS33203-7.4-33	TS33.203 7.4.2a	TS33203-9-8	TS33.203 9	TS33203-8.1-11	TS33.203 8.1
TS33203-7.4-14	TS33.203 7.4.1a	TS33203-7.4-34	TS33.203 7.4.2a	TS33203-9-9	TS33.203 9	TS33203-8.2-1	TS33.203 8.2
TS33203-7.4-15	TS33.203 7.4.1a	TS33203-7.4-35	TS33.203 7.4.2a	TS33203-9-10	TS33.203 9	TS33203-8.2-2	TS33.203 8.2
TS33203-7.4-16	TS33.203 7.4.1a	TS33203-7.4-36	TS33.203 7.4.2a	TS33203-7.4-49	TS33.203 7.4.2a	TS33203-9-1	TS33.203 9
TS33203-7.4-17	TS33.203 7.4.1a	TS33203-7.4-37	TS33.203 7.4.2a	TS33203-7.4-50	TS33.203 7.4.2a	TS33203-9-2	TS33.203 9
TS33203-7.4-18	TS33.203 7.4.1a	TS33203-7.4-38	TS33.203 7.4.2a	TS33203-7.5-1	TS33.203 7.5	TS33203-9-3	TS33.203 9
TS33203-7.4-19	TS33.203 7.4.1a	TS33203-7.4-39	TS33.203 7.4.2a	TS33203-8-1	TS33.203 8	TS33203-9-4	TS33.203 9
TS33203-7.4-20	TS33.203 7.4.1a	TS33203-7.4-40	TS33.203 7.4.2a	TS33203-8-2	TS33.203 8	TS33203-9-5	TS33.203 9
TS33203-7.4-21	TS33.203 7.4.1a	TS33203-7.4-41	TS33.203 7.4.2a	TS33203-8-3	TS33.203 8	TS33203-9-6	TS33.203 9
TS33203-7.4-22	TS33.203 7.4.1a	TS33203-7.4-42	TS33.203 7.4.2a	TS33203-8-4	TS33.203 8	TS33203-9-7	TS33.203 9
TS33203-7.4-23	TS33.203 7.4.1a	TS33203-7.4-43	TS33.203 7.4.2a	TS33203-8.1-1	TS33.203 8.1	TS33203-9-8	TS33.203 9
TS33203-7.4-24	TS33.203 7.4.1a	TS33203-7.4-44	TS33.203 7.4.2a	TS33203-8.1-2	TS33.203 8.1	TS33203-9-9	TS33.203 9
TS33203-7.4-25	TS33.203 7.4.1a	TS33203-7.4-45	TS33.203 7.4.2a	TS33203-8.1-3	TS33.203 8.1	TS33203-9-10	TS33.203 9
TS33203-7.4-26	TS33.203 7.4.1a	TS33203-7.4-46	TS33.203 7.4.2a	TS33203-8.1-4	TS33.203 8.1		
TS33203-7.4-27	TS33.203 7.4.1a	TS33203-7.4-47	TS33.203 7.4.2a	TS33203-8.1-5	TS33.203 8.1		



Copyright (C) 2005-2010 IPv6 Forum. All Rights Reserved.

This original documentation is produced by SIP IPv6 SWG members of Certification WG in the IPv6 Promotion Council. The SWG members currently include Nippon Telegraph and Telephone Corporation (NTT), Yokogawa Electric Corporation, University of New Hampshire InterOperability Laboratory (UNH-IOL), and NTT Advanced Technology Corporation (NTT-AT).

No part of this documentation may be reproduced for any purpose without prior permission.



Authors' List

Timothy Winters (UNH-IOL)

Yoshio Yoshida (NTT-AT)

Nobuyuki Yajima (NTT-AT)

Takaaki Tanaka(NTT-AT)

Kenzo Kodama (NTT-AT)

Naomi Orimo(NTT-AT)

Yoshihiro Inoue (NTT-AT)

Hiroko Nakagawa(NTT-AT)